

**AERONAUTICAL COMMUNICATIONS PANEL (ACP)
WORKING GROUP C**

**Meeting #9
IATA, Montreal
4 – 8 April 2005**

**Implementation Manual for the
Universal Access Transceiver (UAT)
Draft Revision 1.5
22 March 2005**

Change Record

Date/Version	Change
21 July 2003/v0.1	Original Draft
20 February 2004/v0.2	As prepared for review for the UAT Subgroup meeting in Montreal, 1-4 March 2004.
4 March 2004/v0.3	As modified during the UAT Subgroup meeting in Montreal, 1-4 March 2004
12 August 2004/v0.4	<ul style="list-style-type: none"> a. Indicating suggestions made during ICAO ACP WG-C meeting in Montreal, 19-21 April 2004, and entering those suggestions as actions, highlighted in yellow, b. incorporating other material as completions of action items, highlighted in yellow, and c. generally preparing the document for review for the UAT Subgroup meeting in Madrid, 15-17 September 2004.
17 September 2004/v0.5	Review of the status of action items and discussion during the UAT Subgroup meeting in Madrid, 15-17 September 2004.
16 November 2004/v1.0	As agreed to in the Minutes of WG-C Meeting in Munich, the revision level was set to v1.0 after no comments were received from WG-C members. Version 1.0 was the document going into the review during the UAT Subgroup meeting in Montreal, 16-18 November 2004.
18 November 2004/v1.1	Action Item completions were included and highlighted in yellow for the benefit of review by the UAT Subgroup during the meeting in Montreal, 16-18 November. The UAT Subgroup performed detailed page-by-page reviews and made numerous editorial changes and modifications of Action Items as reflected in Version 1.1.
31 January 2005/v1.2	Add an Action Item in §7.2 for Larry Bachman to include a table that shows separation distance as a function of DME/TACAN power.
2 March 2005/v1.3	As modified during the UAT Subgroup meeting #9 in Montreal, 28 February – 2 March.
17 March 2005/v1.4	As modified during the UAT Subgroup meeting #10 in Montreal, 14 - 17 March 2005.
22 March 2005/v 1.5	As updated in preparation for review by ACP WG-C at their Meeting #9, 4-8 April 2005. Updates included text in Section 8 related to Spurious Emissions and insertions of several updated figures in section 6 for examples of descriptions of UAT Ground Infrastructure.

TABLE OF CONTENTS

1	<u>INTRODUCTION</u>	9
1.1	OUTLINE OF THE MANUAL	9
1.2	OBJECTIVE AND SCOPE	10
1.3	DEFINITIONS	10
2	<u>OPERATING CONCEPTS</u>	14
2.1	APPLICATIONS SUPPORTED	14
2.1.1	AUTOMATIC DEPENDENT SURVEILLANCE –BROADCAST (ADS-B)	14
2.1.2	GROUND UPLINK SERVICES	15
2.1.3	UAT BROADCAST CONNECTIVITY	16
2.2	FREQUENCY CHANNEL AND WAVEFORM DESCRIPTION	16
2.3	TIMING STRUCTURE AND MEDIUM ACCESS	17
2.3.1	UAT ADS-B MESSAGE TRANSMISSION BY AIRCRAFT	18
2.3.2	GROUND UPLINK SERVICES	19
2.4	BASIC AVIONICS OPERATION AND EQUIPAGE LEVELS	19
2.4.1	AVIONICS OPERATING CONCEPT	19
2.4.2	EXAMPLES OF UAT EQUIPAGE CLASSES	21
2.4.2.1	UAT ADS-B Transmitting Subsystem	26
2.4.2.2	UAT Receiving Subsystem	26
2.5	GROUND STATION OPERATION	26
3	<u>SCHEDULING OF UAT ADS-B MESSAGES</u>	29
3.1	MESSAGE DATA BLOCK SELECTION CYCLE	29
3.1.1	ADS-B MESSAGE DATA BLOCK TYPE ALLOCATION	29
3.1.2	MESSAGE TRANSMISSION CYCLE	29
4	<u>UAT ADS-B TRANSMITTING SUBSYSTEM INPUT REQUIREMENTS</u>	31
5	<u>UAT AIRCRAFT INSTALLATION GUIDANCE</u>	33
5.1	AIRCRAFT MUTUAL SUPPRESSION BUS	33
5.2	UAT SUPPRESSION PULSE IMPACT ON COSITE SSR, ACAS AND DME PERFORMANCE	33
5.2.1	ANALYSIS OF IMPACT ON DME	34
5.2.2	ANALYSIS OF IMPACT ON ACAS	34
5.2.3	ANALYSIS OF IMPACT ON SSR TRANSPONDERS	35
5.3	SHARING ANTENNAS WITH SSR TRANSPONDER	35
5.3.1	OPTIONAL DIPLEXER REQUIREMENTS	36
5.3.1.1	The UAT Diplexer Channel	37
5.3.1.2	The Transponder Diplexer Channel	37

5.3.1.3	UAT Diplexer Channel to Transponder Diplexer Channel Isolation	38
5.4	COMPATIBILITY WITH SSR IF NOT SHARING ANTENNAS.....	38
5.5	UAT INTERFACE TO GPS/GNSS RECEIVER	38
6	<u>UAT GROUND INFRASTRUCTURE.....</u>	40
6.1	GENERAL DESCRIPTION	40
6.1.1	UPLINK: BROADCAST	40
6.1.1.1	Geometric Service Volume.....	40
6.1.1.1.1	FIS-B Product Coverage.....	41
6.1.1.1.2	TIS-B Product Coverage	42
6.1.1.2	Data Source for Ground Broadcast.....	42
6.1.2	DOWNLINK: SURVEILLANCE.....	42
6.1.3	SUMMARY OF INFRASTRUCTURE AND IMPLICATIONS	43
6.2	GROUND STATION DEPLOYMENT	44
6.2.1	TIME SLOTS AND “DATA CHANNELS”	44
6.2.2	ANTENNA CONSIDERATIONS FOR UPLINK	45
6.2.3	TIS-B SITE IDENTIFIER (ID)	47
6.2.4	SECTORIZED CELLS AND CO-SITE TRANSMISSION ISOLATION	49
6.3	RF INTERFERENCE.....	51
6.3.1	JTIDS INTERFERENCE.....	51
6.3.2	DME INTERFERENCE	51
6.4	MULTIPLE ADS-B LINKS.....	52
7	<u>UAT FREQUENCY PLANNING CRITERIA</u>	53
7.1	USE OF 978 MHZ FOR DME/TACAN	53
7.2	DME/TACAN TO UAT GROUND STATION SITING CRITERIA.....	53
8	<u>GUIDANCE ON UAT SPURIOUS EMISSIONS.....</u>	54
8.1	ITU REGULATIONS.....	54
8.2	APPLICATION OF THE ITU REGULATION TO THE UAT CASE.....	56
8.3	CONCLUSION	56
9	<u>POTENTIAL FUTURE SERVICES OF UAT.....</u>	57
A.	<u>ACRONYMS & DEFINITION OF TERMS.....</u>	3
A.1	ACRONYMS.....	3
A.2	DEFINITION OF TERMS.....	7
B	<u>UAT SYSTEM PERFORMANCE SIMULATION RESULTS.....</u>	3
B.1	INTRODUCTION	3
B.1.1	ORGANIZATION	3
B.1.2	BACKGROUND	3

B.1.3	GENERAL ASSUMPTIONS.....	4
B.1.4	UAT DETAILED SIMULATION DESCRIPTION AND LIMITATIONS.....	4
B.2	ANTENNA MODEL	6
B.3	RECEIVER PERFORMANCE MODEL	8
B.3.1	MEASURED DATA	8
B.3.2	RECEIVER MODEL.....	12
B.3.2.1	Receiver Model Accuracy.....	12
B.4	MULTI-AIRCRAFT SIMULATION (MAUS) RESULTS.....	16
B.4.1	LOS ANGELES BASIN 2020 (LA2020).....	16
B.4.2	CORE EUROPE 2015	24
B.4.3	LOW DENSITY SCENARIO.....	32
B.4.4	ACQUISITION PERFORMANCE.....	34
B.4.5	SURFACE PERFORMANCE	35
B.4.6	AN A0 ON THE SURFACE RECEIVING AN AIRCRAFT THAT IS ON APPROACH.....	36
B.4.7	TIS-B PERFORMANCE OF UAT IN THE LA 2020 ENVIRONMENT.....	38
B.4.7.1	Additional TIS-B Assumptions.....	38
B.4.7.2	TIS-B Results.....	39
B.4.7.2.1	TIS-B Hotspot Analysis.....	41
B.5	MODEL VALIDATION.....	44
C	<u>STANDARD INTERFERENCE ENVIRONMENT.....</u>	<u>3</u>
C.1	BACKGROUND.....	3
C.2	OPERATIONAL ENVIRONMENTS	3
C.3	CO-SITE ENVIRONMENT	6
C.4	SCENARIO ASSESSMENTS	7
D.	<u>UAT RECEIVER PERFORMANCE IN THE PRESENCE OF JTIDS/MIDS, DME/TACAN AND SELF-INTERFERENCE.....</u>	<u>3</u>
D.1	INTRODUCTION.....	3
D.2	PRE-PRODUCTION TESTING	3
D.2.1	DME/TACAN TESTING.....	3
D.2.2	JTIDS/MIDS TESTING.....	11
D.2.3	UAT SELF-INTERFERENCE TESTING.....	12
D.2.4	COMBINED INTERFERENCE TESTING	13
D.3	PRODUCTION TESTING.....	13
D.3.1	DME/TACAN TESTING.....	13
D.3.2	UAT SELF-INTERFERENCE TESTING.....	13
D.4	SUMMARY	15
E	<u>UAT ERROR DETECTION AND CORRECTION PERFORMANCE</u>	<u>3</u>
F.	<u>DME OPERATION IN THE PRESENCE OF UAT SIGNALS.....</u>	<u>3</u>
G.	<u>EXAMPLE ADS-B MESSAGE ENCODING.....</u>	<u>3</u>

G.1	REED SOLOMON ENCODING OF MESSAGE DATA BLOCK	3
G.2	REED SOLOMON ENCODING OF BASIC TYPE 0 ADS-B MESSAGE DATA BLOCK.....	3
G.3	REED SOLOMON ENCODING OF LONG TYPE 1 ADS-B MESSAGE DATA BLOCK.....	5
<u>H.</u>	<u>AIRCRAFT ANTENNA CHARACTERISTICS.....</u>	<u>3</u>
H.1	ANTENNA CHARACTERISTICS	3
H.1.1	GENERAL CHARACTERISTICS	3
H.1.2	RADIATION PATTERNS	3
H.1.3	DIRECTIONAL GAIN RADIATION PATTERNS	3
H.2	TYPICAL VSWR MEASUREMENTS OF EXISTING TRANSPONDER / DME ANTENNAS.....	5
H.2.1	SENSOR SYSTEMS L BAND BLADE ANTENNA P/N S65-5366-7L	7
H.2.2	AEROANTENNA P/N AT-130-1	7
H.2.3	¼ WAVE WHIP ANTENNA	7
H.3	PASSIVE ANTENNA DIPLEXER CHARACTERISTICS	8
H.3.1	ANTENNA DIPLEXER TESTING	9
H.3.1.1	SSR Transponder Testing	9
H.3.1.2	UAT Diplexer Testing	12
H.3.1.3	Prototype Diplexer Performance	13
H.3.2	TYPICAL INSTALLATION DIAGRAM	16
<u>I.</u>	<u>SIMULATED RESULTS FOR DELIVERY OF FOUR TRAJECTORY CHANGE REPORTS OVER UAT IN CORE EUROPE 2015</u>	<u>3</u>
I.1	INTRODUCTION	3
I.2	INTENT RESULTS USING FOUR-SECOND EPOCH	3
I.3	INTENT RESULTS USING FIVE SECOND EPOCH	5
<u>J.</u>	<u>UAT GROUND STATION DATA CHANNEL ASSIGNMENT GUIDANCE.....</u>	<u>3</u>
J.1	INTRODUCTION.....	3
J.2	IDEAL CASE	3
J.2.1	ALTERNATIVE VIEW OF IDEAL CASE	6
J.2.2	ALTERNATIVE DCB ASSIGNMENTS	9
J.3	DEPLOYMENT EXAMPLE.....	9
J.3.1	AN IMPLEMENTATION EXAMPLE	10
<u>K.</u>	<u>FUTURE RANGE VALIDATION OF UAT MESSAGES.....</u>	<u>3</u>
K.1	BACKGROUND.....	3
K.2	INSTALLED END-END TIMING PERFORMANCE	3
K.3	UAT TIMING REQUIREMENTS	5
K.4	CONSIDERATIONS FOR ADS-B VALIDATION TECHNIQUES.....	6

LIST OF FIGURES

Figure 2-1: UAT Connectivity	16
Figure 2-2: UAT Frame	18

Figure 2-3: High Level Function of UAT Avionics	20
Figure 2-4: UAT Ground Station Simplified Block Diagram.....	27
Figure 3-2: Transmitter Antenna Use for Diversity Installations	30
Figure 5-1: Optional Passive Diplexer Block Diagram	36
Figure 5-2: UAT Interface to GPS/GNSS Receiver	39
Figure 6-1: Example Coverage Cell Layout	41
Figure 6-2: General Form of Ground Infrastructure	44
Figure 6-3: 7-Data Channel Block Re-Use Pattern.....	45
Figure 6-4: Self-Interference with Low-Gain Antenna.....	46
Figure 6-5: Self-Interference with DME-Type Antenna.....	47
Figure 6-6: Example of TIS-B Site ID and Data Channel	48
Figure 6-7: Sectorized Antenna Pattern (3 sectors)	50
Figure 6-8: Possible UAT Ground Station Antenna Geometries.....	50
Figure 8-1: Unwanted Emissions and necessary Bandwidth	55
<u>Figure A-1: Ideal eye diagram</u>	<u>9</u>
<u>Figure A-2: Distorted eye diagram</u>	<u>9</u>
<u>Figure B-1: TLAT Antenna Model Elevation Gain.....</u>	<u>7</u>
<u>Figure B-2: TLAT Random Azimuth Gain.....</u>	<u>8</u>
<u>Figure B-3: Test Setup for measuring BER.....</u>	<u>9</u>
<u>Figure B-4: BER Due to DME interference.....</u>	<u>11</u>
<u>Figure B-5: BER Due to DME Interference</u>	<u>11</u>
<u>Figure B-6: Link 16 Interference</u>	<u>12</u>
<u>Figure B-7: Gaussian Noise + Single UAT, 1.2 MHz Receiver</u>	<u>13</u>
<u>Figure B-8: Gaussian Noise + Two Equal UATs, 1.2 MHz Receiver</u>	<u>13</u>
<u>Figure B-9: Two Unequal UATs, INR \gg 0 dB, 0.8 MHz Receiver</u>	<u>14</u>
<u>Figure B-10: N Equal UATs, INR \gg 0, 0.8 MHz Receiver</u>	<u>14</u>
<u>Figure B-11 Model Errors for All Data, 1.2 MHz Receiver</u>	<u>15</u>
<u>Figure B-12: Model Errors for All Data, 0.8 MHz Receiver.....</u>	<u>15</u>
<u>Figure B-13: Air-to-Air Reception by A3 Receiver at High Altitude over LA 2020</u>	<u>18</u>
<u>Figure B-14: Air-to-Air Reception by A3 Receiver at FL 150 over LA 2020</u>	<u>18</u>
<u>Figure B-15: Air-to-Air Reception by A2 Receiver at High Altitude over LA 2020</u>	<u>19</u>
<u>Figure B-16: Air-to-Air Reception by A2 Receiver at FL 150 over LA 2020</u>	<u>19</u>
<u>Figure B-17: Air-to-Air Reception by A1 Receiver at High Altitude over LA 2020</u>	<u>20</u>
<u>Figure B-18: Air-to-Air Reception by A1 Receiver at FL 150 over LA 2020</u>	<u>20</u>
<u>Figure B-19: Air-to-Air Reception by A0 Receiver at FL 150 over LA 2020</u>	<u>21</u>
<u>Figure B-20: Air-to-Ground Reception by a Receiver at LAX in LA 2020</u>	<u>21</u>
<u>Figure B-21: Reception of Ground Vehicle Transmissions by Aircraft on Approach at 2000 feet into LAX in 2020.....</u>	<u>22</u>
<u>Figure B-22: 95th Percentile Update Interval for Target State Reports as a Function of Range for A3 and A2/A1H Transmitters.....</u>	<u>24</u>
<u>Figure B-23: Air-to-Air Reception by A3 Receiver at High Altitude over BRU in CE 2015</u>	<u>26</u>
<u>Figure B-24: Air-to-Air Reception by A3 Receiver at FL 150 over BRU in CE 2015</u>	<u>27</u>
<u>Figure B-25: Air-to-Air Reception by A2 Receiver at High Altitude over BRU in CE 2015.....</u>	<u>27</u>
<u>Figure B-26: Air-to-Air Reception by A2 Receiver at FL 150 over BRU in CE 2015</u>	<u>28</u>
<u>Figure B-27: Air-to-Air Reception by A1 Receiver at High Altitude over BRU in CE 2015</u>	<u>28</u>
<u>Figure B-28: Air-to-Air Reception by A1 Receiver at FL 150 over BRU in CE 2015</u>	<u>29</u>
<u>Figure B-29: Air-to-Air Reception by A0 Receiver at FL 150 over BRU in CE 2015</u>	<u>29</u>
<u>Figure B-30: Air-to-Ground Reception at BRU in CE 2015</u>	<u>30</u>
<u>Figure B-31: Air-to-Ground Reception Using a 3-Sector Antenna at BRU in CE 2015</u>	<u>30</u>
<u>Figure B-32: Air-to-Ground Reception 2 NM from a 10 kW TACAN Using a 3-Sector Antenna at BRU in CE 2015</u>	<u>31</u>
<u>Figure B-33: Reception of Ground Vehicle Transmissions by Aircraft on Approach at 2000 feet into BRU in 2015 with 10 kW 979 MHz TACAN at Airport.....</u>	<u>31</u>

<u>Figure B-34:</u> A3 Receiver in Low Density Scenario Receiving A3 Transmissions	33
<u>Figure B-35:</u> Receptions of A3 Transmissions by a UAT Ground Receiver in a Low Density Scenario co-located with a TACAN at 979 MHz with -30 dBm Power at the UAT Antenna.....	34
<u>Figure B-36:</u> A0 Receivers on the Ground in LA2020 Receiving All Aircraft on Approach at an Altitude of 2000 feet.....	37
<u>Figure B-37:</u> A0 Receivers on the Ground in CE2015 Receiving All Aircraft on Approach at an Altitude of 2000 ft to Brussels co-located with a 10 kW 979 MHz TACAN.....	37
<u>Figure B-38:</u> Locations of UAT Ground Stations, Including Service Volumes and Number of Uplinks per Second (2008) in Each Service Volume for LA 2020 Scenario.....	38
<u>Figure B-39:</u> TIS-B 95% Update Intervals in LA 2008 (No ADS-B Equipage)	39
<u>Figure B-40:</u> ADS-B 95% Update Interval in Near-Term Scenario	40
<u>Figure B-41:</u> ADS-B Air-to-Air Performance in the Presence of ADS-R Ground Transmissions in LA 2020	41
<u>Figure B-42:</u> 95% State Vector Update Times for an A3 Receiver at 40,000 feet Receiving A3 Transmissions in the Presence of a Ground Station at Various Ranges Broadcasting 1000 TIS-B Messages Per Second.....	42
<u>Figure B-43:</u> 95% State Vector Update Times for an A3 Receiver at 40,000 feet Receiving A3 Transmissions in the Presence of a Ground Station at Various Ranges Broadcasting 500 RIS-B Messages Per Second.....	43
<u>Figure B-44:</u> 95 th Percentile State Vector Updates Times for an A3 Receiver at 40,000 feet Receiving A3 Transmissions in the Presence of a Ground Station 40 NM Away at Various Uplink Rates	44
<u>Figure B-45:</u> Comparison of Bench Test Measurements of MOPS-Compliant UAT Reception in LA2020 Self-Interference with Predictions by MAUS.....	45
<u>Figure B-46:</u> Bench Test Measurements of UAT Performance in Core Europe UAT Self-Interference, Combined with DME/TACAN and Link 16 Interference	46
<u>Figure B-47:</u> Bench Test Measurements of UAT Performance in the LA2020 UAT Self-Interference, Combined with DME/TACAN and Link 16 Interference	47
<u>Figure C-1:</u> Sample Scenario	5
<u>Figure C-2:</u> Normalized DME Pattern	5
<u>Figure C-3:</u> Normalized TACAN Pattern	6
<u>Figure C-4:</u> Targets of Interest for Computing Update Interval	10
<u>Figure D-3:</u> UAT Receiver Performance DME 2700 Pulse Pairs at +2 MHz	4
<u>Figure D-4:</u> UAT Standard Receiver Performance DME 2700 Pulse Pairs at +1 MHz	5
<u>Figure D-5:</u> UAT High Performance Receiver with DME 2700 Pulse Pairs at +1 MHz	6
<u>Figure D-6:</u> UAT Standard Receiver Performance DME 2700 Pulse Pairs On Frequency.....	7
<u>Figure D-7:</u> UAT High Performance Receiver DME 2700 Pulse Pairs on Frequency.....	7
<u>Figure D-8:</u> UAT Standard Receiver Performance DME 3600 Pulse Pairs at +2 MHz	8
<u>Figure D-9:</u> UAT High Performance Receiver DME 3600 Pulse Pairs at +2 MHz	8
<u>Figure D-10:</u> UAT Standard Receiver Performance DME 3600 Pulse Pairs at +1 MHz	9
<u>Figure D-11:</u> UAT High Performance Receiver DME 3600 Pulse Pairs at +1 MHz	9
<u>Figure D-12:</u> UAT Standard Receiver Performance DME 3600 Pulse Pairs On Frequency.....	10
<u>Figure D-13:</u> UAT High Performance Receiver DME 3600 Pulse Pairs on Frequency.....	10
<u>Figure D-14:</u> UAT Receiver Performance DME 2700 Pulse Pairs Offset in Frequency.....	11
<u>Figure D-15:</u> UAT Receiver Performance TACAN 2700 and DME 3600 Pulse Pairs at +1 MHz.....	11
<u>Figure D-16:</u> UAT Receiver Performance with the first JTIDS/MIDS Scenario	12
<u>Figure D-17:</u> UAT Production Standard Receiver Performance Comparison with the Core Europe 2015 Self-Interference Scenario	14
<u>Figure D-18:</u> UAT A3 Receiver Performance Comparison with the Core Europe 2015 Self-Interference Scenario	15
<u>Figure E-1:</u> Basic ADS-B Message Performance	4
<u>Figure E-2:</u> Long ADS-B Message Performance.....	4

<u>Figure E-3:</u> Ground Up Link Message Performance	5
<u>Figure E-4:</u> Ground Up Link Message Undetected Message Error Rate.....	6
<u>Figure E-5:</u> Ground Up Link Message Total Message Error Rate.....	6
<u>Figure E-6:</u> Logical Flow of ADS-B Reception	7
<u>Figure F-1:</u> Bendix King KD-7000 Frequency Offset Test	4
<u>Figure F-2:</u> Bendix King KD-7000 Reply Efficiency Test.....	5
<u>Figure F-3:</u> Bendix King KD-7000 CW testing: DME level –83 dBm	6
<u>Figure F-4:</u> Narco DME-890 Frequency Offset Test.....	7
<u>Figure F-5:</u> Narco DME-890 Reply Efficiency Test	8
<u>Figure F-6:</u> Narco DME-890 CW testing: DME level -75 dBm.....	8
<u>Figure F-7:</u> Honeywell KDM-706A Frequency Offset Test.....	9
<u>Figure F-8:</u> Honeywell KDM-706A Reply Efficiency Test	10
<u>Figure F-9:</u> Honeywell KDM-706A CW testing: DME level –83 dBm.....	11
<u>Figure F-10:</u> Rockwell-Collins DME-900 Frequency Offset Test	11
<u>Figure F-11:</u> Rockwell-Collins DME-900 Reply Efficiency Test	12
<u>Figure F-12:</u> Rockwell-Collins DME-900 CW testing: DME level –83 dBm.....	12
<u>Figure F-13:</u> Comparison of all DME Frequency Offset Tests.....	13
<u>Figure F-14:</u> Comparison of all DME Reply Efficiency Tests	14
<u>Figure F-15:</u> Comparison of all DME CW Interference Tests.....	14
<u>Figure F-16:</u> JTIDS and UAT Combined Interference Analysis	16
<u>Figure H-1:</u> L-Band Passive Gain Antenna	4
<u>Figure H-2:</u> Gain Array Antenna Azimuth Pattern	5
<u>Figure H-3:</u> Jet Transport Antenna	7
<u>Figure H-4:</u> Capstone Antenna	7
<u>Figure H-5:</u> ¼ Wave Whip Antenna	8
<u>Figure H-6:</u> Sensitivity Variation with Frequency, All 1’s Interrogation, Transponder MS-1.....	12
<u>Figure H-7:</u> Diplexer UAT Port.....	13
<u>Figure H-8:</u> Diplexer Transponder Port.....	14
<u>Figure H-9:</u> Diplexer UAT-to-Transponder Port Isolation	15
<u>Figure H-10:</u> Diplexer Installation.....	16
<u>Figure I-1:</u> 95th Percentile Trajectory Change Report Update Times for an A3 Receiver at High Altitude in CE 2015 over Brussels Using TC Rotation to Deliver Messages Containing Information for 3 or 4 TCRs	4
<u>Figure I-2:</u> 95th Percentile Trajectory Change Report Update Times for an A3 Receiver at High Altitude in CE 2015 over Brussels Using a 5 Second Epoch to Deliver 4 TC Messages.....	5
<u>Figure I-3:</u> 95th Percentile Target Change Report Update Times for an A3 Receiver at High Altitude in CE 2015 over Brussels Comparing Both Methods for Delivering 4 TC Messages.....	6
<u>Figure J-1:</u> Basic Pattern (4)	5
<u>Figure J-2:</u> The (4, 4) Pattern for Tiers 1 & 2	6
<u>Figure J-3:</u> Tier 3 of Pattern (4, 3, 3)	7
<u>Figure J-4:</u> Tiers 2 and 3 of Pattern (4, 3, 3).....	8
<u>Figure J-5:</u> Complete Pattern (4, 3, 3).....	8
<u>Figure J-6:</u> Conceptual View of Uplink Service Volume in Cross Section	9
<u>Figure J-7:</u> USA East Coast Coverage at 40000’ AMSL.....	11
<u>Figure J-8:</u> USA East Coast Coverage at 10000’ AGL.....	11
<u>Figure J-9:</u> USA East Coast Coverage at 3000’ AGL.....	12

LIST OF TABLES

Table 2-1: Examples of UAT Installed Equipment Classes.....	25
Table 2-2: Transmitter Power Levels.....	26
Table 3-1: Message Data Block Type Code Allocation.....	29
Table 4-1: UAT ADS-B Transmitting Subsystem Input Requirements	32
Table 6-1: Example of Site ID Table.....	49
Table 7-1: Maximum Power of a 979 MHz DME/TACAN for a given Separation Distance to a UAT Ground Station Receiver.....	54
Table 7-2: Minimum Distance of a UAT Ground Station Receiver to a 979 MHz DME/TACAN.....	54
Table 9-1: Summary of Potential Future Applications of UAT.....	58
<u>Table B-1</u> : Ranges of Compliance for UAT Transmit-Receive Combinations in the LA2020 Scenario	22
<u>Table B-2</u> : Ranges of ADS-B Compliance for UAT Transmit-Receive Combinations in CE 2015 Scenario	32
<u>Table B-3</u> : Acquisition Requirements.....	35
<u>Table B-4</u> : 99 th Percentile Range for Information Acquisition for Various Combinations of Transmit-Receive Pairs (NM).....	35
Table B-5: 95% Update Times for ADS-R Transmissions from UAT Ground Stations in LA 2020.....	40
<u>Table C-1</u> : Signal Level Analysis of the Sample Scenario	6
<u>Table C-2</u> : Interference Scenarios and Implementation Assumptions.....	8
<u>Table C-3</u> : Received Power Levels (dBm) for Current European DME/TACAN Environment.....	9
<u>Table C-4</u> : Received Power Levels (dBm) for 2015 European DME/TACAN Environment.....	9
<u>Table C-5</u> : Co-site Environment	9
<u>Table C-6</u> : Overview of Scenario Assessments	11
<u>Table E-1</u> : Maximum Undetected RS Word Error Rates.....	3
<u>Table E-2</u> : Upper Bounds on Undetected Message Error Probabilities.....	9
<u>Table G-1</u> : Example of Basic ADS-B Message Data Blocks	4
<u>Table G-2</u> : Example of Long Type 1 ADS-B Message Data Blocks.....	6
<u>Table H-1</u> : Typical Antennas.....	6
<u>Table H-2</u> : Diplexer Testing with ATC Transponders	10
<u>Table J-1</u> : Data Channel Mapping to DCB for the 5-4-2 Plan.....	9
<u>Table K-1</u> : Worst Case Timing Offset.....	4

1 Introduction

1.1 Outline of the Manual

This Manual contains general informative information and implementation guidance for the Universal Access Transceiver (UAT).

Section 1 of this document presents the objectives and scope of the manual and provides definition of key terms used in this Manual.

Section 2 describes the applications supported by UAT and the fundamentals of system operation and introduces an example set of airborne equipage classes.

Section 3 provides guidance for scheduling of UAT ADS-B Message transmissions by each of the example airborne equipage classes described in Section 2.

Section 4 provides guidance on UAT ADS-B transmitter inputs by each of the example airborne equipage classes described in Section 2.

Section 5 provides guidance on UAT aircraft installation aspects.

Section 6 provides guidance on the implementation of UAT Ground Infrastructure. Assumptions consistent with this guidance have been used to estimate UAT performance when supporting air-ground applications of ADS-B.

Section 7 describes UAT frequency planning criteria.

Section 8 describes guidance on UAT spurious emissions.

Section 9 describes potential future services that could be supported by UAT.

Appendix A is a listing of acronyms and definition of terms.

Appendix B summarizes results of detailed UAT System performance simulations in the Standard Interference Environments of Appendix C. Air-to-air, air-to-ground and ground-to-air system performances are assessed. All performance estimates reflect broadcast of all State Vector (SV), Mode Status (MS), and Intent information (including both Target State and Trajectory Change Reports), as appropriate to the UAT equipage class.

Appendix C describes the standard interference environments assumed for the performance simulations documented in Appendix B. These environments are based upon internationally-developed traffic scenarios for future high and low density airspace and near-worst-case estimates of interference caused by other systems transmitting on or near the UAT intended operational frequency of 978 MHz.

Appendix D describes measurement data that were collected on UAT equipment, including production-level equipment, to characterize UAT receiver performance in various interference environments, including JTIDS/MIDS, DME/TACAN and self-interference, as described in Appendix C.

Appendix E describes the UAT Error Detection and Correction Performance.

Appendix F describes test results that substantiate compatibility of the UAT System with Distance Measuring Equipments (DMEs).

Appendix G contains a specific example of a UAT ADS-B Message, formatted in a manner consistent with Section 12.4.4 of the UAT SARPs and Section 2.1 of the UAT Manual on Detailed Technical Specifications.

Appendix H contains information and guidance regarding Aircraft Antenna Characteristics. A technique for sharing existing transponder antennas is described.

Appendix I contains an approach for UAT to convey Trajectory Change Reports (TCRs), a type of intent information. The Appendix contains a description of how up to four (4) TCRs may be supported by the system.

Appendix J contains guidance on UAT Ground Station Data Channel Assignment.

Appendix K contains information on a future range validation capability for UAT ADS-B Messages.

1.2 Objective and Scope

The objective of this manual is to supplement the UAT SARPs and the UAT Manual on Detailed Technical Specifications with additional information related to implementation guidance and UAT system performance.

1.3 Definitions

Appendix A provides a definition of the terms and acronyms used in this document. This section expands upon the definitions of key terms in order to increase document clarity and establish a common foundation of terminology.

UAT: Universal Access Transceiver (UAT) is a broadcast datalink operating on 978 MHz, with a modulation rate of 1.041667 Mbps..

UAT ADS-B Message: UAT ADS-B Messages are broadcast once per second by each aircraft to convey State Vector and other information. UAT ADS-B Messages can be in one of two forms depending on the amount of information to be transmitted in a given second: the *Basic UAT ADS-B Message* or the *Long UAT ADS-B Message* (see §12.4.4.1 of the UAT SARPs for definition of each).

UAT Ground Uplink Message: The UAT Ground Uplink Message is used by Ground Stations to broadcast, within the Ground Segment of the UAT Frame, flight information such as text and graphical weather data, advisories, and other aeronautical information, to aircraft that are in the service volume of the Ground Station (see Section §**Error!** **Reference source not found.** of the UAT SARPs for further details).

Standard Receiver: A general purpose receiver satisfying the minimum rejection requirements of interference from adjacent frequency DMEs (see Section §**Error!** **Reference source not found.** of the UAT SARPs for further details).

High Performance Receiver: A UAT receiver with enhanced selectivity to further improve the rejection of adjacent frequency DME interference (see Section §**Error!** **Reference source not found.** of the UAT SARPs for further details).

Optimum Sampling Point: The optimum sampling point of a received UAT bit stream is at the nominal center of each bit period, when the frequency offset is either plus or minus 312.5 kHz.

Power Measurement Point (PMP): A cable connects the antenna to the UAT equipment. The PMP is the end of that cable that attaches to the antenna. All power measurements are considered as being made at the PMP unless otherwise specified. The cable connecting the UAT equipment to the antenna is assumed to have 3 dB of loss.

Successful Message Reception (SMR): The function within the UAT receiver for declaring a received message as valid for passing to an application that uses received UAT messages. See Section 4.0 of the UAT Manual on Detailed Technical Specifications for a detailed description of the procedure to be used by the UAT receiver for declaring successful message reception.

Pseudorandom Message Data Block: Several UAT requirements state that performance will be tested using pseudorandom message data blocks. Pseudorandom message data blocks should have statistical properties that are nearly indistinguishable from those of a true random selection of bits. For instance, each bit should have (nearly) equal probability of being a ONE or a ZERO, independent of its neighboring bits. There should be a large number of such pseudorandom message data blocks for each message type (Basic ADS-B, Long ADS-B or Ground Uplink) to provide sufficient independent data for statistical performance measurements. See Section 2.3 of the UAT Manual on Detailed Technical Specifications for an example of how to provide suitable pseudorandom message data blocks.

Service Volume: A part of the facility coverage where the facility provides a particular service in accordance with relevant SARPs and within which the facility is afforded frequency protection.

Additional Acronyms and Definitions of terms are provided in Appendix A of this Manual.

This Page Intentionally Left Blank

2 Operating Concepts

2.1 Applications Supported

2.1.1 Automatic Dependent Surveillance –Broadcast (ADS-B)

Automatic Dependent Surveillance – Broadcast (ADS-B) is a surveillance technique in which aircraft automatically provide, via a broadcast-mode data link, data derived from on-board navigation and position fixing systems, including aircraft identification, four-dimensional position, and additional data as appropriate.

With such information made available by ADS-B from other proximate aircraft, it is possible to establish the relative position and movement of those aircraft with reference to one's own aircraft. It is also possible for ground-based facilities to monitor ADS-B broadcasts to enable basic surveillance capabilities, or to supplement existing surveillance systems. Other data that are shared using ADS-B include information related to the aircraft's intended flight path (“intent” data), aircraft type, and other information.

ADS-B is automatic in the sense that no pilot or controller action is required for the information to be broadcast. It is dependent surveillance in the sense that the aircraft surveillance-type information is derived from on-board navigation equipment.

ADS-B is considered to be a key enabling technology to enhance safety and efficiency in airspace operations. These include basic applications, such as the use of ADS-B to enhance the pilot's visual acquisition of other nearby aircraft¹, as well as more advanced applications, such as enabling enhanced closely spaced parallel approach operations. Other applications involving airport surface operations, improved surveillance in non-radar airspace, and advanced conflict management are also described. Fleet management and search and rescue are also applications that can be supported by ADS-B.

Initial PANS-ATM procedures for the use of ADS-B, including ADS-B provided over the UAT data link, will likely use ADS-B in a traditional “radar-like” manner in order to provide separation in airspaces that do not have radar coverage. The standardization of air-to-air use of ADS-B for applications other than those of a purely advisory nature will have a further consequential effect on PANS-ATM and other ICAO documents. Such standardization is likely to build upon efforts currently in progress in several Regions to harmonize such applications.

¹ Ground vehicles in the movement area, obstacles, etc., may also transmit UAT ADS-B Messages when appropriate. In appropriate contexts, the term “aircraft” may include such other transmitters.

2.1.2 Ground Uplink Services

In the context of this manual, Traffic Information Service - Broadcast (TIS-B) is a ground-based service to UAT-equipped aircraft to provide surveillance data on non-UAT-equipped aircraft. The service is intended to provide UAT-equipped aircraft with a more-complete traffic picture in situations where not all aircraft are equipped with UAT.

When providing surveillance data for non-ADS-B equipped aircraft, TIS-B involves three major functions. First, another source of surveillance information on non-ADS-B aircraft (such as Secondary Surveillance Radar [SSR]) must be available. Second, this surveillance information must be converted and processed so as to be usable by UAT-equipped aircraft. And third, UAT is used to convey this information to UAT-equipped aircraft.

When providing surveillance data for ADS-B equipped aircraft that are equipped with a data link other than UAT, the TIS-B service takes as input ADS-B reports from such aircraft and converts those reports to a format appropriate to UAT, for uplink broadcast to UAT equipped aircraft.

UAT preferably supports TIS-B by having UAT ground uplink stations transmit TIS-B information as UAT ADS-B Messages in the ADS-B segment of the UAT frame. The discussion of TIS-B in this manual is based upon supporting TIS-B through uplink ADS-B Messages. Alternatively, if necessary, TIS-B information could be broadcast in the ground segment of the UAT frame, but not in the format of a UAT ADS-B Message.

FIS-B is the ground-to-air broadcast of non-control, advisory information needed by pilots to operate more safely and efficiently. For example, FIS-B may provide weather graphics and text (e.g., METAR and TAF), Special Use Airspace information, Notices to Airmen, and other information. UAT has been designed to support the broadcast of FIS-B information in the ground segment of the UAT frame using the ground uplink message.

2.1.3 UAT Broadcast Connectivity

Figure 2-1 below shows the connectivity supported by UAT for ADS-B air-air, ADS-B air-ground, and the uplink services of FIS-B and TIS-B.

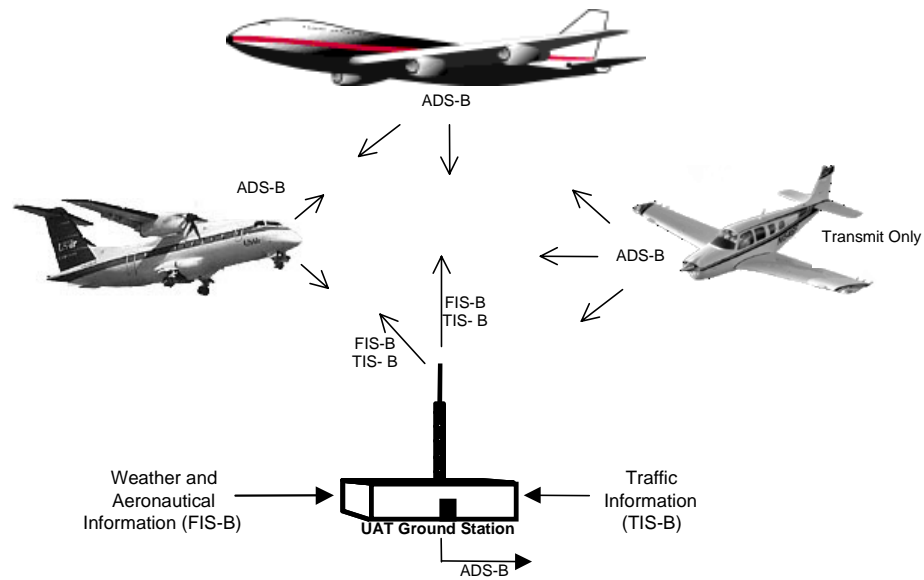

Figure 2-1: UAT Connectivity

Aircraft UAT equipment may support transmit-only or transmit and receive capability. When aircraft are in the service volume of a Ground Station, uplink services may be provided and the Ground Station can serve as a surveillance sensor for ground based ADS-B applications. Regardless of whether airborne users are in coverage of a Ground Station or not, air-air ADS-B connectivity is available. While networking of Ground Stations can offer certain advantages, each can also operate independently of others if desired. Requirements for coordination among Ground Stations are that they all operate on a common time standard and that the ground uplink Data Channels (see §6.2.1) on which they transmit are assigned through appropriate coordination on a Regional basis.

2.2 Frequency Channel and Waveform Description

The UAT employs a single common global frequency channel to support ADS-B and appropriate ground uplink services. The UAT frequency channel is at 978 MHz and has a modulation rate of just over 1 Mbps. A single frequency channel architecture ensures seamless air-to-air connectivity and obviates the need for multi-channel receivers or tuning procedures. The UAT frequency channel has been sized to ensure ADS-B performance is maintained in future high traffic density environments. Additionally, the UAT waveform has been designed specifically to provide tolerance to self-interference and other pulsed interference encountered in the frequency band of UAT operation. The UAT waveform is defined in the UAT SARPs.

Detailed information on UAT ADS-B performance assessment in low density and in projected future high-density traffic environments is provided in Appendix B. This assessment also accounts for all expected sources of interference from other systems as described in Appendix C. Appendix D describes the bench test measurements used to develop receiver performance models that provide the underpinning of the simulations in Appendix B.

There are two types of broadcast transmissions - or messages - on the UAT frequency channel: the UAT ADS-B Message, and the UAT Ground Uplink Message. Regardless of type, each message has two fundamental components: the Message Data Block that contains user information, and message overhead, principally consisting of Forward Error Correction (FEC) code parity, that supports the error-free transfer of the data. The FEC was selected to ensure that UAT Messages would be received with an undetected error rate, at the UAT link layer, of at most one in 10^{-8} per UAT Message. Details on the format of these message types are provided in §12.4.4 of the UAT SARPs. Details on the contents and format of the Message Data Blocks are provided in §2.1 of the UAT Manual on Detailed Technical Specifications.

Information on the error detection and correction performance of the UAT FEC scheme is provided in Appendix E.

Finally, test results assessing the impact of the UAT waveform on DME equipment are presented in Appendix F. Guidance on sharing antennas with SSR transponders is provided in Appendix H.

2.3 Timing Structure and Medium Access

UAT support for multiple services is accomplished using a hybrid medium access approach that incorporates both time-slotted and pseudorandom access. By virtue of its waveform, modulation rate, precise time reference, and message-starting discipline, UAT may potentially be used for independent validation of position information of received UAT ADS-B Messages (see §5.3).

Figure 2-2 illustrates the Basic UAT Message timing structure called a UAT frame. A frame is one second long and begins at the start of each Universal Coordinated Time (UTC) second. Each frame is divided into two segments:

1. The Ground Segment in which UAT Ground Uplink Messages are broadcast in one or more time slots, and
2. The ADS-B Segment in which UAT ADS-B Messages are broadcast.

Guard times are incorporated between the segments to allow for signal propagation and timing drift. The UAT frame contains 3952 Message Start Opportunities (MSOs) that are spaced at $250\mu\text{s}$ intervals. This spacing represents the smallest time increment used by UAT for scheduling message transmissions, and all such transmissions must start only at a valid MSO.

Note: *The MSO concept was established primarily to govern the transmission protocol used by avionics UAT transmitters—as detailed in §3.1.2 of the UAT Manual on Detailed Technical Specifications. The MSO serves to constrain the*

selection from among any of the 3200 MSOs in the segment to start transmission of the message. Approximately 6 milliseconds of guard time are appended after the ADS-B Segment to fill out the UAT frame to the end of the UTC second.

The pseudorandom selection of an MSO within each UAT frame for the start of an aircraft's UAT ADS-B Message is intended to prevent two aircraft from systematically interfering with each other's UAT ADS-B Message transmissions. Adherence to the MSO-based timing scheme enables the receiving UAT equipment to determine range to the UAT equipment that transmitted the message. This information could be used in validity checks of the position data conveyed in the UAT ADS-B Message itself. More information on UAT support for an independent ADS-B validation application is presented in §5.3.

Construction of an example UAT ADS-B Message Data Block including the FEC is provided in Appendix G.

2.3.2 Ground Uplink Services

UAT Ground Uplink Messages are used to support services such as FIS-B and TIS-B. UAT Ground Uplink Messages will occur within one or more of the 32 time slots defined within the ground segment of the UAT frame. Detailed procedures for UAT Ground Uplink Message transmission are provided in §3.

UAT Ground Stations can support TIS-B through transmission of individual messages in the ADS-B format in the ADS-B segment of the frame. Using this approach, TIS-B transmissions will appear to be nearly identical to UAT ADS-B Messages both in terms of message format and media access. Each such TIS-B transmission must start only at a valid MSO as is the case with transmission of ADS-B Messages from aircraft. UAT can also support TIS-B through transmissions in the Ground Uplink segment. This approach for transmission of TIS-B information is beyond the scope of this Manual.

2.4 Basic Avionics Operation and Equipage Levels

2.4.1 Avionics Operating Concept

Implementations will consist of transmit and receive subsystems. Most implementations will include both subsystems; however, transmit-only configurations are also possible. Figure 2-3 shows the high level functions of an avionics implementation that supports both transmission and reception.

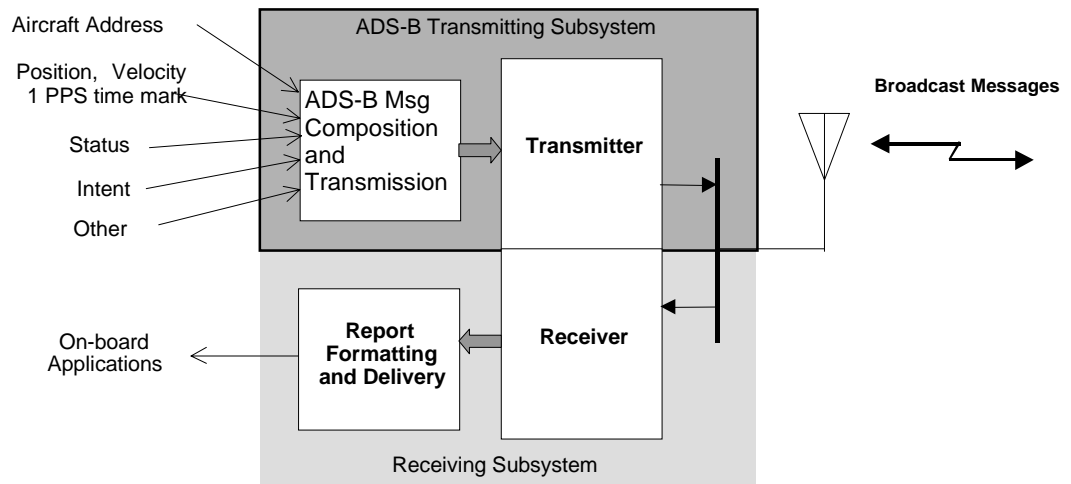

Figure 2-3: High Level Function of UAT Avionics

The UAT ADS-B Transmitting Subsystem performs the following basic functions:

- a. Determine the proper message format based on the predetermined (fixed) message transmit schedule.
- b. Receive various ADS-B input data and format into the UAT ADS-B Message structure.
- c. Determine appropriate MSO for transmission (once per second) based on pseudorandom seed.
- d. Select the antenna for transmission (for installations requiring transmit diversity, see §2.4.2).
- e. Transmit the message over the UAT frequency channel.

These functions result in one message transmitted each second. Additionally, the UAT ADS-B Transmitting Subsystem may make a determination of whether its “Vertical Status” is ON GROUND or AIRBORNE. For installations that can determine the Vertical Status, the UAT ADS-B Message format, antenna selection, and MSO selection algorithm may change in several respects depending on the Vertical Status declared. Reference §2.1.5, and §3.1.2.1 in the UAT Manual on Detailed Technical Specifications and §3.1.2 of this Manual.

The UAT Receiving Subsystem performs the following basic functions:

- a. Select antenna for reception (in installations that employ antenna switching, but do not employ receiver diversity, see §2.4.2).
- b. Detection and decoding of UAT Messages (both Ground Uplink Messages and UAT ADS-B Messages) on the UAT frequency channel.

- c. Apply “Successful Message Reception” criteria to each detected message to ensure integrity.
- d. For each Successful Message Reception, format resulting Message Data Block into report format and output report to on-board applications.

Reports to on-board applications are generated in response to received UAT Messages (both Ground Uplink Messages and UAT ADS-B Messages). Each UAT Message successfully received will trigger the generation of a report, which includes the Message Data Block information of that message and an indication of the time of message receipt. Robust forward error correction coding is used to ensure that the received message is identical to that transmitted.

2.4.2 Examples of UAT Equipage Classes

RTCA has categorized ADS-B equipment into equipage classes as defined in RTCA/DO-242A, the ADS-B MASPS (Minimum Aviation System Performance Standards). This categorization is based on potential ADS-B applications and the needs of particular airspace users. This Manual provides, for exemplary purposes, configurations of UAT avionics consistent with the RTCA equipage categories. Appendix B to this Manual provides projected UAT performance for each of these equipage classes using both high and low-density traffic scenarios. For UAT ADS-B equipment, the installed performance of these equipment classes is defined by Table 2-1.

Aircraft systems supporting both transmission and reception of UAT Messages, termed Class A UAT Systems, are defined by equipage classification according to the provided user capability. All Class A UAT Airborne configurations support the provision of at least basic air-ground ATC surveillance services. The variations listed below are primarily distinguished by their support of air-to-air applications. The following types of Class A¹ systems are defined:

1. Class A0: Supports minimum Message transmission and reception capability for UAT ADS-B participants that always operate below 18,000 feet MSL. Air-to-air ADS-B applications for this Class of equipage are intended to support a range of at least 10 NM between participants (an air-to-air range of at least 20 NM has been projected). Broadcast UAT ADS-B Messages are based upon own-platform source data. UAT ADS-B Messages received from other aircraft support generation of UAT ADS-B reports that are used by on-board applications.
2. Class A1: Supports all class A0 functionality and supports ADS-B air-to-air applications to a range of at least 20 NM between participants. For UAT, the A1 equipage class has been divided into two classes. For A1 aircraft that always operate below 18,000 feet MSL, the “A1 Low” class is created, and abbreviated throughout this document as “A1L.” For A1 aircraft that have no altitude operating restrictions, the “A1 High” class is created, and abbreviated throughout this document as “A1H.” The major equipment performance difference between classes A1L and A1H is the

¹ There may be future recognition of Receive-Only configurations in which the requirements for an appropriate Class A Receive capability are met. Such configurations would be intended for use only in aircraft that support an interactive capability on an alternate ADS-B data link.

Transmitter RF output power. An air-to-air range of at least 40 NM has been projected for Class A1H equipment.

3. Class A2: Supports all Class A1 functionality and supports ADS-B air-to-air applications to a range of at least 40 NM between participants. Additional data is supplied in ADS-B Messages to support further ADS-B air-to-air applications for receiving aircraft. This service requires the broadcast and receipt of intent information contained in Target State and Trajectory Change Reports.
4. Class A3: Supports all Class A2 functionality and has additional range capability for UAT ADS-B air-to-air applications between A3 equipped users of at least 120 NM. Class A3 has the ability to broadcast and receive multiple Trajectory Change reports. The analysis in Appendix B, which assumes a particular method of transmitting two Trajectory Change reports, indicates that the exchange of a second Trajectory Change report at distances of 120 NM is accomplished at approximately one-half of the update rate of the first Trajectory Change report. Alternative methods of transmitting up to four Trajectory Change reports for an ADS-B system participant are discussed in Appendix I.

The UAT SARPs refer to “Standard” and “High Performance” Receivers. Class A3 equipment employs the High Performance Receiver and the remaining Class A equipments employ the Standard Receiver. The performance projections in Appendix B of this Manual assume that receivers for UAT Ground Stations are Standard Receivers with a receiver sensitivity at the unit 2 dB better than the sensitivity of a Standard Receiver in an aircraft.

The High Performance Receiver employs a narrower bandwidth filter to allow it to better reject adjacent frequency DME emissions. The use of High Performance Receivers is recommended to support longer range air-to-air ADS-B applications in air spaces which have a significant number of DME assignments on frequencies adjacent to the 978 MHz UAT transmission frequency. The narrow bandwidth introduces some distortion of the desired signal that degrades the performance in the presence of self interference. However the benefit of rejecting the DME energy offsets this effect in terms of overall performance. The full effect of the narrow bandwidth filter was accounted for in the performance assessments in Appendix B.

Table 4 in the UAT SARPs specifies a more stringent receiver rejection ratio for High Performance Receivers at a 1 MHz offset from the UAT frequency of 978 MHz than at a -1 MHz offset. This higher rejection ratio requirement was adopted to provide additional performance margin for aircraft UAT equipment operating in a high density 979 MHz DME environment, as is found in the European Region. Additionally, the rejection characteristics in Table 4 were found to be provided by readily available avionics components. Should DME operation at 977 MHz reach the level that presently exists at 979 MHz, a symmetric rejection ratio at ± 1 MHz of 40 dB would be desirable.

Some UAT ADS-B system participants will not need to receive information from other participants but will only need to broadcast their State Vector and associated data. Class B UAT ADS-B systems meet the needs of these participants. Class B UAT systems are defined as follows:

1. Class B0: Aircraft broadcast-only system. Class B0 systems require an interface with own-platform navigation systems. Class B0 systems require transmit powers and information capabilities equivalent to those of Class A0. For UAT, Class B0 installations are on aircraft that always operate below 18,000 feet MSL.
2. Class B1: Aircraft broadcast-only system. Class B1 UAT systems require an interface with own-platform navigation systems. Class B1 UAT systems require transmit powers and information capabilities equivalent to those of Class A1H.
3. Class B2: Vehicle broadcast-only UAT ADS-B system. Class B2 UAT systems require a high-accuracy source of navigation data and a nominal 5 NM effective broadcast range. Vehicles qualifying for UAT ADS-B equipage may be limited to those that operate within the surface movement area.
4. Class B3: Fixed obstacle broadcast-only UAT ADS-B system. Collocation of the transmitting antenna with the obstacle is not required as long as broadcast service volume requirements are met. Structures and obstructions identified by appropriate ATS authorities as safety hazards may have their positions communicated to aircraft using UAT.

UAT Ground Stations are discussed in §2.5.

The complete set of ADS-B information transmitted will vary somewhat for each equipment class as determined by the schedule of UAT ADS-B Message Data Blocks to be transmitted by each equipment class (see §3.1.1 of this Manual). Receiving applications can infer the equipment class of a system participant by observing the set of UAT ADS-B Message Data Blocks being received from each participant. Certain air-to-air applications may require the receiving application to determine the applications supported by ADS-B targets under surveillance. In the future this information will be explicitly encoded in the Message Data Block of the Mode Status Element (see the UAT Manual on Detailed Technical Specifications §2.1.5.4).

Important characteristics of the UAT ADS-B Class A and Class B equipage classes are summarized in Table 2-1.

Table 2-1: Examples of UAT Installed Equipment Classes

Equipage Class	Air-to-Air Application Ranges Supported	Transmit RF Power Delivered to Antenna System	Intended Antenna Diversity (when Airborne for Classes A & B0-B1)	
			Transmit	Receive
A0	10 NM	Low Power <i>(Altitude always below 18,000 feet)</i>	Single Antenna (see Note 4)	Single Antenna (see Note 4)
A1L	20 NM		Alternating every 2 sec.	Alternating every sec.
A1H			Medium Power	Alternating every 2 sec.
A2	40 NM	Medium Power	Alternating every 2 sec.	Dual Receiver
A3	120 NM	High Power	Alternating every 2 sec.	Dual Receiver
B0	10 NM	Low Power <i>(Altitude always below 18,000 feet)</i>	Single Antenna (see Note 4)	n/a
B1	20 NM	Medium Power	Alternating every 2 sec.	n/a
B2	5 NM	+28 to +32 dBm	Single Antenna	n/a
B3	5 NM	+30 dBm (minimum)	Single Antenna	n/a

Notes:

1. See §2.4.2.1 for definition of Transmitter RF power levels.
2. Transmitter RF power requirement depends on the aircraft maximum altitude capability. Low-altitude aircraft (maximum certified altitude for aircraft <18,000 feet MSL) need not support the higher-power transmitter requirements due to line-of-sight limitations.
3. Top antenna is not required if use of a single antenna does not degrade signal propagation. This allows for single antenna installation on radio-transparent airframes.
4. For a single-antenna installation, antenna gain pattern performance should be shown at least equivalent to that of a quarter-wave resonant antenna mounted on the fuselage bottom surface.

5. For further information on Antenna diversity see RTCA DO-282A, §2.2.8.1 and §2.2.6.1.3 or equivalent certification guidance.
6. Consistent with Table 1 of the UAT SARPs Section 12.1.2.3.1, projected performance is 20 NM for Class A0 and 40 NM for Class A1H. The intended ranges in the Table above were taken from the UAT Requirements and Desirable Features document and used as “design-to” numbers.

2.4.2.1 UAT ADS-B Transmitting Subsystem

A UAT ADS-B Transmitting Subsystem is classified according to the unit’s range capability and the set of parameters it is capable of transmitting. Table 2-2 defines the transmitter power levels. Power levels are measured in terms of power presented to the transmitting antenna.

Table 2-2: Transmitter Power Levels

Power Classification	Minimum Power at Antenna	Maximum Power at Antenna
Low	7.0 watts (+38.5 dBm)	18 watts (+42.5 dBm)
Medium	16 watts (+42 dBm)	40 watts (+46 dBm)
High	100 watts (+50 dBm)	250 watts (+54 dBm)

Note: These transmitter power levels are referenced to the power at the antenna end of the cable that connects the UAT equipment to the antenna. A unity gain (0.0 dBi) antenna is assumed. Alternate means that demonstrate equivalent performance can be used. Refer to Appendix H in this Manual for guidance.

2.4.2.2 UAT Receiving Subsystem

All Class A receivers have the same sensitivity requirements. The receiver sensitivity at the receiver antenna end of the cable connecting the antenna to the equipment (after antenna gain and before cable loss), for 90% Message Success Rate in the absence of interference, is –93 dBm for Long UAT ADS-B Messages, –94 dBm for Basic UAT ADS-B Messages, and –91 dBm for Ground Uplink (ground-to-air) messages. Performance of Class A receivers in the presence of interference is discussed in Appendices B and D.

2.5 Ground Station Operation

The UAT Ground Station will operate as a UAT ADS-B sensor similar to that of airborne units. The UAT System has been designed to support line-of-sight air-to-ground ADS-B service volume for a single Ground Station, even in future high-density airspaces. The ground subsystem will also be capable of transmitting UAT Ground Uplink Messages in one or more of the 32 assigned Ground Segment time slots. TIS-B uplink from a UAT Ground Station can utilize the UAT ADS-B Message format and the ADS-B segment of the UAT frame; in this event, the avionics Receiving Subsystem makes no distinction in its processing of UAT ADS-B and TIS-B data (although the airborne application can

distinguish these via the Address Qualifier field). Alternatively, in particular traffic environments, a UAT Ground Station may transmit TIS-B information in one or more of the 32 assigned Ground Segment time slots.

The typical UAT Ground Station antenna is 6-8 dBi gain, omni-directional, and DME-like (the maximum EIRP of the UAT Ground Station is, per UAT SARPs §12.1.2.3.2, 58 dBm). High-density traffic environments may require use of separate transmit and receive antenna, and/or sectorized receive antenna (see Appendix H of this Manual). The air-ground performance estimates of Appendix B assume a Ground Station receiver sensitivity of -98 dBm, measured at the receiver end of the cable connecting the UAT equipment to the Ground Station antenna. Figure 2-4 gives an overview of the Ground Station.

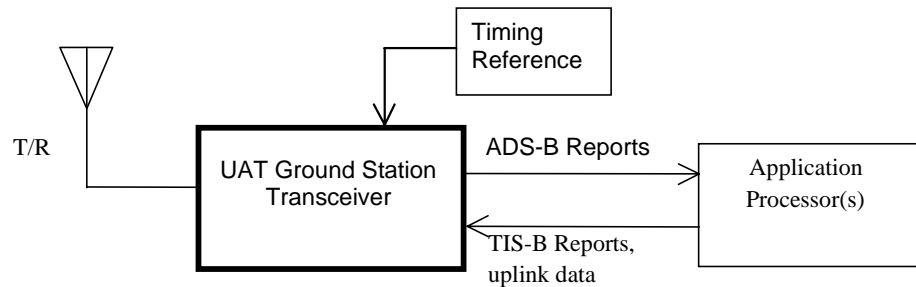

Figure 2-4: UAT Ground Station Simplified Block Diagram

A single Ground Station antenna/transceiver is capable of supporting the following functions:

1. Receiving air-ground UAT ADS-B Messages and producing UAT ADS-B reports.
2. Providing time-of-arrival measurement of UAT ADS-B receptions for range-to-target measurement that is independent of the ADS-B reported position.
3. Ground broadcast service uplink (e.g., TIS-B, FIS-B).
4. Providing timing beacon to airborne users that can provide backup timing (see the UAT Manual on Detailed Technical Specifications, §3.1.1.2(c)). In order to implement this backup timing capability the Ground Station will need to provide Ground Uplink Messages on a regular basis.

Networked Ground Stations with overlapping service volumes can support surveillance based on the “multilateration” technique even if the aircraft that is under surveillance does not have a position available to be reported within its UAT ADS-B Message.

Additional guidance on operation of ground infrastructure including network aspects and interference considerations is provided in Section §6 of this Manual.

This Page Intentionally Left Blank

3 Scheduling of UAT ADS-B Messages

3.1 Message Data Block Selection Cycle

UAT ADS-B Message Data Block types are to be transmitted according to a Message Data Block selection cycle defined to ensure timely transmission of appropriate ADS-B information. For the exemplary equipment classes of Table 2-1, UAT ADS-B Messages of seven different Message Data Block types (out of 32 possible Message Data Block types) have been defined. Each equipment class transmits up to four of these Message Data Block types in a pre-determined sequence: Message Data Block Selection (MDBS)-A, MDBS-B, MDBS-C, and MDBS-D.

3.1.1 ADS-B Message Data Block Type Allocation

For the exemplary equipment classes of Table 2-1 of this Manual, Table 3-1 below specifies the Message Data Block selections, using UAT ADS-B Message Data Block Type Codes defined in Table 2-2 of the UAT Manual on Detailed Technical Specifications.

Table 3-1: Message Data Block Type Code Allocation

Equipment Class	MDBS-A	MDBS-B	MDBS-C	MDBS-D
A0, A1L, A1H, B0, B1	1	0	2	0
A1H, B1 (see Note 2)	3	6	0	6
A2	1	4	4	4
A3	1	4	5	4
B2, B3	1	0	0	0

Notes:

1. *This schedule is to be followed regardless of the unavailability of any Message Data Block fields.*
2. *Optional Message Data Block Type Code assignment if the installation can support transmission of Target State information.*

3.1.2 Message Transmission Cycle

A message transmission cycle of 16 seconds is defined to ensure a proper mix of Message Data Blocks for installations that support ADS-B Message transmission from dual (diversity) antennas. When an aircraft is determined to be in the AIRBORNE condition, transmissions occur through Top (T) (if so equipped) and Bottom (B) antennas each Message Transmission Cycle as shown in Figure 3-2.

Antenna	T	T	B	B	T	T	B	B	T	T	B	B	T	T	B	B
MDBS #	A	B	C	D	D	A	B	C	C	D	A	B	B	C	D	A
Seconds	1	2	3	4	5	6	7	8	9	10	11	12	13	14	15	16

Figure 3-2: Transmitter Antenna Use for Diversity Installations

Notes:

1. *There is no requirement that transmission cycle boundaries be aligned among Aircraft/Vehicles (A/Vs); it is used only to ensure proper mix of transmitted message types.*
2. *For AI receivers with antenna diversity provided by switching according to §2.4.2, this transmission pattern ensures that each Message Data Block type is communicated via each possible transmit/receive antenna combination (T/T, T/B, B/T, B/B) once during each 16 second cycle. It also minimizes the maximum spacing between any two transmissions of the same type.*

When an aircraft is determined to be in the ON-GROUND condition, the top antenna (if so equipped) is selected for all transmissions. The transmission sequences are as shown in Figure 3-2, second and third rows.

4 UAT ADS-B Transmitting Subsystem Input Requirements

- a. The UAT ADS-B Transmitting Subsystem should accept the input data elements listed in Table 4-1 via an appropriate data input interface and use such data to establish the corresponding ADS-B Message contents.
- b. Data elements indicated as “Optional,” that have no input interface, should always indicate the “data unavailable” condition, or be processed using the “data unavailable” procedures related to that element.

Table 4-1: UAT ADS-B Transmitting Subsystem Input Requirements

Element #	Input Data Element	Relevant Paragraph	Data Lifetime (seconds)	Applicability to UAT Equipment Class						
				A0, B0	A1L	A1H, B1	A2	A3	B2	B3
1	ICAO 24-bit Address		No limit	M	M	M	M	M	M ⁽¹⁾	M ⁽¹⁾
2	Latitude ⁽²⁾		2	M	M	M	M	M	M	M
3	Longitude ⁽²⁾		2	M	M	M	M	M	M	M
4	Altitude Type Selection (Barometric vs Geometric)		60	O	O	O	O	O	n/a	M
5	Barometric Pressure Altitude		2	M	M	M	M	M	n/a	n/a
6	Geometric Altitude		2	M	M	M	M	M	n/a	M
7	NIC		2	M	M	M	M	M	M	M
8	Automatic AIRBORNE / ON-GROUND Indication		2	O	O	M	M	M	n/a	n/a
9	North Velocity ⁽²⁾		2	M	M	M	M	M	M	M
10	East Velocity ⁽²⁾		2	M	M	M	M	M	M	M
11	Ground Speed		2	O	O	M	M	M	O	n/a
12	Track Angle		2	O	O	M	M	M	n/a	n/a
13	Heading		2	O	O	M	M	M	n/a	n/a
14	Barometric Vertical Rate		2	M	M	M	M	M	n/a	n/a
15	Geometric Vertical Rate ⁽²⁾		2	O	O	O	O	O	n/a	n/a
16	A/V Length and Width, and POA		No limit	M	M	M	M	M	M	M
17	UTC 1 PPS Timing ⁽²⁾		2	M	M	M	M	M	M	M
18	Emitter Category		No limit	M	M	M	M	M	M	M
19	Call Sign		60	M	M	M	M	M	O	O
20	Emergency / Priority Status Selection		60	M	M	M	M	M	O	n/a
21	SIL		60	M	M	M	M	M	M	M
22	NAC _P ⁽²⁾		2	M	M	M	M	M	M	M
23	NAC _V ⁽²⁾		2	M	M	M	M	M	n/a	n/a
24	NIC _{BARO}		2	Can be internally "hard coded"		M	M	M	n/a	n/a
25	CDTI Traffic Display Capability		60	M	M	M	M	M	n/a	n/a
26	ACAS Installed and Operational		60	M	M	M	M	M	n/a	n/a
27	ACAS Resolution Advisory Flag		18	Required only if the UAT ADS-B Transmitting Subsystem is intended for installation with ACAS; otherwise can be "hard coded"						
28	IDENT Selection		60	M	M	M	M	M	M	n/a
29	"Receiving ATC Services" Flag		60	M	M	M	M	M	M	n/a
30	"True/Magnetic" Indicator Flag		60	n/a	n/a	O	M	M	M	n/a
31	Heading / Track Indicator		60	n/a	n/a	O	M	M	n/a	n/a
32	Target Source Indicator (Horizontal)		60	n/a	n/a	O	M	M	n/a	n/a
33	Horizontal Mode Indicator (Horizontal)		60	n/a	n/a	O	M	M	n/a	n/a
34	Target Heading or Track Angle		60	n/a	n/a	O	M	M	n/a	n/a
35	Target Altitude Type		60	n/a	n/a	O	M	M	n/a	n/a
36	Target Source Indicator (Vertical)		60	n/a	n/a	O	M	M	n/a	n/a
37	Mode Indicator (Vertical)		60	n/a	n/a	O	M	M	n/a	n/a
38	Target Altitude Capability		60	n/a	n/a	O	M	M	n/a	n/a
39	Target Altitude		60	n/a	n/a	O	M	M	n/a	n/a
40	Radio Altitude		2	O	O	O	O	O	n/a	n/a
41	Pressure Altitude Disable		No limit	M	M	M	M	M	n/a	n/a
42	Airspeed		2	O	O	O	O	O	n/a	n/a

O = Optional

M = Mandatory (the equipment must have the ability to accept the data element)

n/a = not applicable to this equipage class

Notes: ⁽¹⁾ Non-Aircraft Identifier may be assigned by the appropriate ATS Authority.
⁽²⁾ If input is not directly accessible, a means to verify the encoding must be demonstrated.

5 UAT Aircraft Installation Guidance

5.1 Aircraft Mutual Suppression Bus

The UAT Manual on Detailed Technical Specifications, in section 4.2, requires UAT equipment to output suppression pulses during UAT transmission. In practice these pulses will be transmitted on the aircraft's Mutual Suppression Bus. On aircraft without such a bus, the installation of UAT equipment effectively results in such a bus being implemented. The Mutual Suppression Bus is used in aircraft for L-Band systems such as Secondary Surveillance Radar (SSR) transponders, ACAS and DMEs. The L-Band systems on the aircraft physically connect to the common bus. The L-Band systems that are connected to the bus may drive the bus to announce to other systems that a transmission is taking place during the interval that the bus is activated. They may also listen on the bus to react to other L-Band transmissions on the aircraft. The L-Band systems that listen on the bus may choose to delay their own transmissions so as not to simultaneously transmit while another L-Band system is transmitting and/or desensitize its receiver to protect itself during high powered transmissions which could damage or impair its receive capability. Overall guidance is normally given for Mutual Suppression Bus circuitry so that it is designed to protect from malfunctioning devices connected to the Bus from impacting other systems connected to it.

5.2 UAT Suppression Pulse Impact on Cosite SSR, ACAS and DME Performance

As mentioned above, systems operating within the L-Band frequency band may need interference protection from each other to ensure safe and proper operation. A major consideration of systems connecting to and driving the mutual suppression bus is to minimize the duration of the suppression to minimize the impact to other connected systems. This section describes analysis that demonstrates that UAT operation does not unacceptably impact performance of cosite SSR, ACAS or DME systems.

UAT is required to drive the Mutual Suppression Bus during the UAT transmission. UAT does not monitor the Mutual Suppression Bus so it does not inhibit or delay its transmissions as a result of Mutual Suppression Bus pulses from other L-Band systems connected to the bus. The impact to the UAT receiver during other L-Band transmissions was considered when assessing UAT receiver performance in high density airspace, as the UAT receiver was considered completely blanked during on-board L-Band transmissions from ACAS, SSR transponders and DME. The UAT system performance estimates in Appendix B reflect this conservative blanking assumption. UAT averages one transmission per second and transmits either a Basic Message, which is 280 microseconds in duration, or a Long Message, which is 420 microseconds. The suppression interval is required, per section 4.2 of the UAT Manual on Detailed Technical Specifications, to be active during the transmission interval when the power is -20 dBm or higher. The -20 dBm requirement was developed based on the maximum power allowable without SSR transponders generating unsolicited replies when signal levels from the UAT frequency skirts within the transponder receiver band are above the transponder receiver threshold. The worst case maximum suppression interval allowed is 430 microseconds. The impact of this suppression interval to other L-Band systems will be shown individually.

5.2.1 Analysis of Impact on DME

The impact of the mutual suppression interval as a result of on-board UAT transmissions on DME systems was assessed. The short duration of the UAT suppression is insignificant to the DME transmitter/interrogator. The DME operation can safely withstand interrogation delays of 430 microseconds that may result if worst case delay were imposed on the DME. Looking at the receiver blanking of DME that would result from UAT suppression activity, the 0.043% worst case blanking is insignificant when considering that DME operation is acceptable at relatively low reply efficiencies. Appendix F of the UAT Implementation Manual contains data showing consistent DME operation on four different DME units when a reply efficiency of 30% or more is achieved. The measurements were performed relative to two performance criteria used in DME operation: 1) Acquire Stable Operating Point (ASOP), the point that prohibits the DME to acquire a track, 2) Break Stable Operating Point (BSOP), the point that causes DME to lose a track that it has already acquired. DME reply efficiency is reduced by many factors including interference from other systems and compatibility studies have been conducted to verify satisfactory DME operation against potential interference rates from these systems. UAT Mutual Suppression bus occupation rate of 0.043% is an insignificant factor to DME reply efficiency reduction.

5.2.2 Analysis of Impact on ACAS

ACAS systems connect to the Mutual Suppression Bus and are required to accept and respond to suppression pulses from the bus so that ACAS activity is disabled when other L-Band equipment transmit. The ACAS receiver, which decodes SSR Mode C/S signals, is required to recover to within 3 dB of normal receiver sensitivity within 15 microseconds after the end of the suppression pulse. UAT Long Message transmissions would result in a worst case 445 microsecond desensitization of the ACAS receiver. ACAS activity can be divided into three major functions: 1) Listening period for transponder acquisition squitters, 2) Whisper-shout interrogation/reply processing, 3) Mode S interrogation/reply processing. The impact of UAT Mutual Suppression Bus activity can be assessed for each of these functions. The potential blanking of a 445 microsecond interval during the Listening period of squitters is not a significant performance issue. Acquisition squitters are broadcast randomly on average once per second. The probability of reception of an aircraft squitter is reduced by 0.045% by the UAT Mutual Suppression Pulses and is not a significant factor in squitter acquisition. The probability of two squitters from the same aircraft being missed on subsequent seconds due to UAT is in the order of 2×10^{-7} . The impact of missing a single acquisition squitter at any point in time is not a performance issue for ACAS given that the link margin allows reception of acquisition squitters with enough margin to obtain a squitter and allowing ACAS to acquire the aircraft prior to the aircraft being within range of the aircraft for threat determination. The whisper-shout function is an interrogation sequence to acquire SSR Mode A/C transponder equipped aircraft which varies interrogation power levels to reduce aircraft replies in a systematic way to reduce reply garbling that can occur in high density airspace. Whisper-shout interrogations occur at defined power levels and typically one to six power levels are transmitted under normal operating conditions. Whisper-shout interrogation power levels can go over 120 per second in a high density aircraft situation. The 445 microsecond UAT interval per second is not a significant impact to the Whisper-shout sequence of ACAS. The 445 microseconds may blank the receiver and cause one or more missed replies in any one second. But since the UAT transmission is random and a low probability exists for losing

more than one reply from any individual aircraft from the Whisper-shout interrogation sequence, this aspect of ACAS performance remains acceptable with UAT Mutual Suppression Bus blanking. The impact of UAT Mutual Suppression Bus to the Mode S interrogation interval of ACAS is not a significant performance issue. The ability of ACAS to re-interrogate a particular aircraft if a reply is not received mitigates any risk of not receiving a reply from any individual interrogation. The main sources of interference are co-frequency SSR Mode A/C/S fruit that overlaps desired replies. The limited UAT blanking of the ACAS receiver is not a significant factor.

5.2.3 Analysis of Impact on SSR Transponders

The impact of UAT occupation of the Mutual Suppression Bus on SSR transponders was also considered. This was looked at from the perspective of the addition of UAT suppression interval to transponder availability. With the exception of the Acquisition and Extended Squitter transmissions of a Mode S transponder, the transponder transmits on a request basis from Ground and Airborne interrogators, including Ground SSR Mode A/C/S, both EnRoute and Terminal, and ACAS. Transponder availability is impacted by several mechanisms. Transponders have side lobe suppression (SLS) functionality to inhibit the transponder from responding to interrogations for a defined interval (typically 35 microseconds). Ground interrogators use SLS to prevent transponders from replying to interrogations that are not within the main beam of the rotating antenna. The transponder is additionally not available due to active interrogation acceptance/reply and recovery interval. In high density airspace, where the number of Ground interrogators and the number of aircraft is high, the transponder has a reduced availability due to the high number of interrogations. The transponder is also not available due to other on-board L-Band systems such as ACAS and DME that blank the transponder receiver. Worst case transponder availability relative to all of these factors can be determined for a high density environment by using the number of SSR Mode A/C/S and ACAS interrogations in the Core Europe 2015 future high density scenario contained in Appendix C, Table C-5, along with measured data from high density areas. The worst case transponder availability is calculated to be around 90%, meaning that the transponder cannot respond to interrogations at most 10% of the time. The addition of the UAT Mutual Suppression Bus blanking of the SSR transponder receiver reduces the availability at most from 90% to 89.957%. This reduction is not a significant impact to SSR transponders.

5.3 Sharing Antennas with SSR Transponder

A potential method of providing an antenna for the UAT is to use a passive frequency Diplexer that is installed between an existing transponder and its antenna. The use of a Diplexer to operate UAT equipment and the on-board SSR transponder must ensure proper operation of UAT equipment and SSR transponders. Certain characteristics were critical to enable the use of a Diplexer. The power loss across the Diplexer was an important consideration. The typical cable attenuation that installations allow between the SSR transponder and antenna is 3 dB. The Diplexer cannot use up a significant portion of this allocation without eliminating most existing transponder installations as candidates for UAT antenna sharing. The requirement that the Diplexer loss cannot exceed 0.5 dB is expected to enable most existing installations to use a Diplexer and share the transponder antenna. The goals of the Diplexer design were to support a transponder port that would minimize the insertion loss in the 1090 / 1030 MHz band and

possessing adequate passband so that 1030 MHz interrogation signals and 1090 MHz reply signals were unaffected by the Diplexer.

As shown in Figure 5-1, the Diplexer is a passive device and consists of three ports that provide connectivity from the UAT port to the antenna port (UAT Diplexer Channel) and connectivity from the Mode A/C/S port (Transponder Diplexer Channel) to the antenna port. An optional DC path in the Transponder Diplexer Channel is allowed so that installations that require antenna sensing can maintain the capability to sense the presence of an antenna. The Transponder Diplexer Channel will attenuate signals at 978 MHz, providing isolation from the UAT. In some cases, Diplexer isolation actually exceeds the level of isolation obtained by using separate transponder and UAT antennas. The latter is a function of distance between antennas. The UAT's Diplexer port can provide minimal insertion loss to the antenna at 978 MHz while manifesting a high impedance at the 1030 / 1090 MHz band.

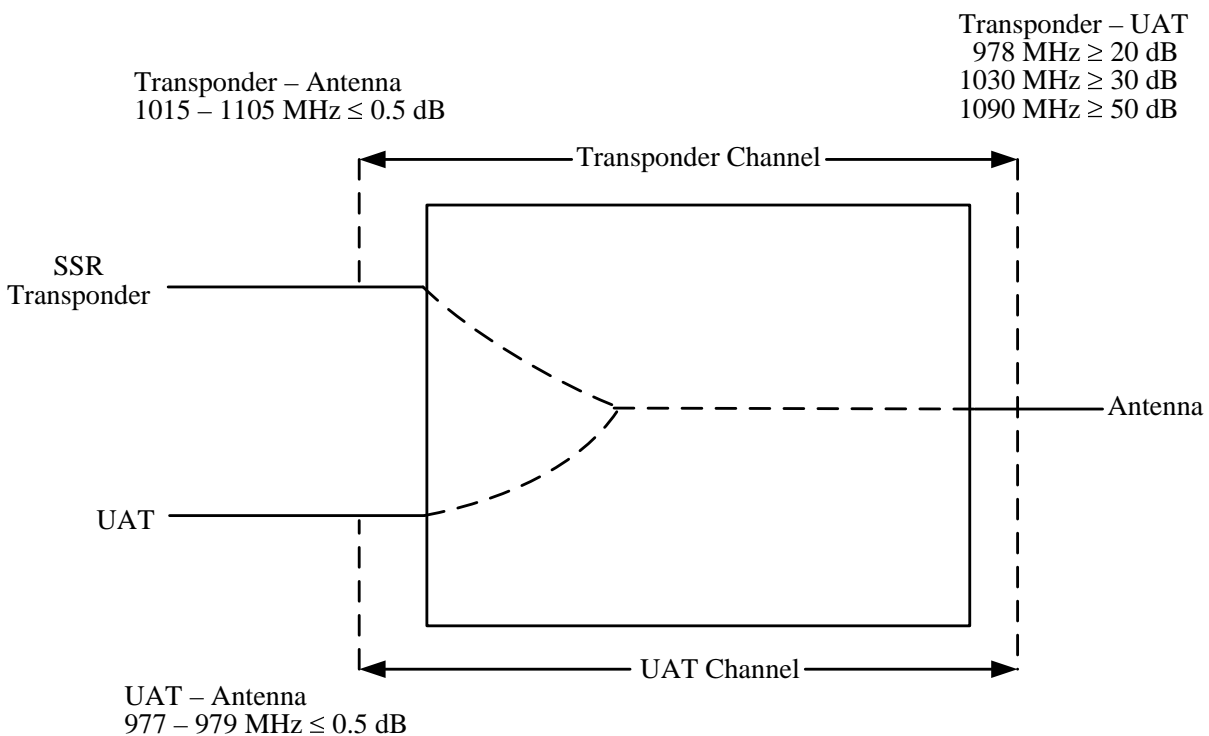

Figure 5-1: Optional Passive Diplexer Block Diagram

5.3.1 Optional Diplexer Requirements

An option to use a passive frequency Diplexer is provided to allow sharing of a single antenna between the Mode A/C/S Transponder and the UAT unit is provided herein. Sharing a common antenna between the two systems may be desirable in aircraft to minimize antenna installation cost and complexity. The UAT Diplexer Channel frequency response requirements ensure adequate passband bandwidth around the 978 MHz UAT frequency to ensure that UAT signal integrity is maintained through the UAT

unit, Diplexer and antenna path. Likewise, the Transponder Diplexer Channel frequency response requirements ensure adequate passband bandwidth around the 1030 MHz and 1090 MHz frequencies to ensure that interrogation and reply signal integrity is maintained through the transponder, Diplexer and antenna path. The Diplexer characteristics must ensure that performance of both the UAT and Transponder systems is equivalent to their performance without the Diplexer. An attenuation of up to 0.5 dB through the Diplexer is acceptable. A delay of up to 30 nanoseconds for the SSR signals through the Diplexer is also acceptable. The insertion loss and delay characteristics of the Diplexer must be taken into consideration when determining cable loss and cable delay budgets between the UAT unit and antenna and the Transponder and the antenna. The use of the Diplexer does not preclude the UAT from driving the suppression bus during UAT transmissions. Diplexer installations must include connection and use of the suppression bus driven by the UAT and received by the Transponder. Installations that incorporate the Diplexer must ensure that the off frequency power seen by the front end of the UAT equipment and the Mode A/C/S transponders through the Diplexer are within the design tolerances of each unit to ensure proper operation. The design of the UAT needs to consider the power seen at the input from the transponder and it should be verified that the transponder design can handle the UAT power through the isolation provided by the Diplexer.

5.3.1.1 The UAT Diplexer Channel

The Diplexer includes a UAT Channel that conveys UAT signals without distortion of the waveform. The UAT Diplexer Channel conveys UAT Basic, Long and Ground Uplink Messages while maintaining the modulation accuracy of the input UAT signals as specified in §12.4.3 in the UAT SARPs, and produce no more than 0.5 dB amplitude attenuation and no more than 30 nanoseconds in propagation delay. Additionally, the variation in delay is no more than 10 nanoseconds over the frequency band of 977 MHz to 979 MHz. The UAT Diplexer Channel provides a passband from no greater than 977 MHz to no less than 979 MHz (2.0 MHz minimum) and a maximum attenuation of 0.5 dB. The minimum and maximum attenuation in the passband are different by no greater than 0.20 dB. The UAT port of the Diplexer is capable of peak power transmissions according to the appropriate aircraft equipage class given by Table 2-1 and Table 2-2. The VSWR produced by the Diplexer at the UAT port, when the other two ports are terminated in a 50 ohm load, does not exceed 1.3:1 for frequencies within the passband.

5.3.1.2 The Transponder Diplexer Channel

The Diplexer includes a Transponder Diplexer Channel that conveys received 1030 MHz interrogation and 1090 MHz reply signals without distortion of the waveform. The Transponder Diplexer Channel conveys pulses that are amplitude modulated on either 1030 MHz or 1090 MHz and having rise and fall times of 50 nanoseconds or more and produce no more than 0.5 dB amplitude attenuation and no more than 10 nanoseconds delay while retaining the pulse rise and fall times and pulse width of the input pulses. Additionally, the variation in delay is no more than 5 nanoseconds over the frequency band of 1015 MHz to 1105 MHz. The Transponder Diplexer Channel provides a passband from no greater than 1015 MHz to no less than 1105 MHz (90 MHz minimum) and a maximum attenuation of 0.5 dB. The minimum and maximum attenuation in the passband are different by no greater than 0.20 dB. The Transponder port is capable of handling 1000 Watts instantaneous power. The VSWR produced by the Diplexer at the

Transponder port, when the other two ports are terminated in a 50 ohm load, does not exceed 1.3:1 for frequencies within the passband. If required by the transponder installation, the Diplexer supports DC coupling from the Transponder port to the antenna port as required by the electrical characteristics of the installed equipment.

5.3.1.3 UAT Diplexer Channel to Transponder Diplexer Channel Isolation

The Diplexer provides RF isolation between the UAT Diplexer Channel and the Transponder Diplexer Channel. The Diplexer provides a minimum of 50 dB of isolation between these ports at 1090 MHz. Additionally, the Diplexer provides a minimum isolation of 30 dB between the UAT and Transponder ports of the Diplexer at 1030 MHz. The Diplexer provides a minimum of 20 dB of isolation between the ports at 978 MHz.

Note: *Installations that incorporate the Diplexer must ensure that the SSR reply power seen by the front end of the UAT Receiver and the UAT transmission power seen by the front end of the SSR Mode A/C/S receiver through the Diplexer are within the design tolerances of each unit to ensure proper operation. It has been determined that the isolations provided above should in general ensure safe operation for most transponders with respect to off frequency effects. This determination should be verified for a specific aircraft installation.*

5.4 Compatibility with SSR If Not Sharing Antennas

This compatibility is assured by the UAT equipment providing suppression pulses as provided by section 4.2 of the UAT Manual on Detailed Technical Specifications, and the supporting analysis shown in section 5.3 above.

5.5 UAT Interface to GPS/GNSS Receiver

UAT Aircraft equipment must be interfaced to a GPS/GNSS receiver in order to obtain Position, Velocity and Time information. One component is a 1 pulse per second Time Mark. Position, Velocity and Timing information are provided over a data interface. Timing information provided over the data interface could include the offset of the Time Mark relative to the 1.0 second UTC epoch (if any) and time of day. Figure 5-2 shows the interfaces and timing requirements related to these interfaces.

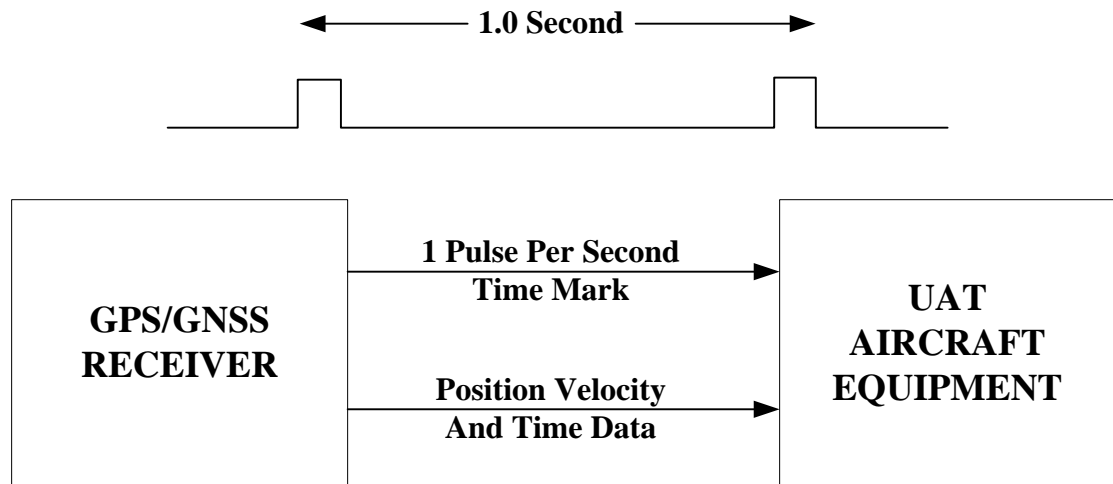

Figure 5-2: UAT Interface to GPS/GNSS Receiver

Notes:

1. *1 Pulse Per Second leading edge should be within ± 1 msec of the 1.0 second UTC epoch.*
2. *Position and Velocity data provided by the GPS/GNSS receiver should be applicable to within ± 5 msec of the 1 Pulse Per Second Time Mark.*
3. *Position, Velocity and Time data should be available to the UAT Aircraft equipment within 200 msec of the leading edge of the 1 Pulse Per Second Time Mark.*

6 UAT Ground Infrastructure

This section describes the working concept for a UAT ground infrastructure. This infrastructure supports the ground-air segment of the overall UAT network. This is not intended to be a specification or set of requirements for such a ground infrastructure, but rather a context in which to understand the intentions of the UAT data link and the provisions made to support the ground infrastructure.

6.1 General Description

The role of the ground infrastructure is twofold:

1. To receive ADS-B broadcasts and generate a summary of the air traffic in a given area, possibly fusing it with other surveillance data (e.g. radar or multilateration systems).
2. To transmit this traffic data along with other flight service information, e.g. weather, NOTAMS, to aircraft for use in the cockpit.

There is considerable flexibility for the deployment and functionality of the ground infrastructure. The receive and transmit functions may be physically separate and even have different providers, or they could be a single ground network of transceivers feeding an integrated system providing all the above functions. This will probably be decided more by economics and regulations than by engineering design. This section only describes enough of the system to allow understanding of the UAT data link and be reasonably sure that it will provide the necessary functionality.

6.1.1 Uplink: Broadcast

6.1.1.1 Geometric Service Volume

Because of the limited range and geometry of a single Ground Station, a network of ground broadcast transmitting stations will be required to provide service over a large area. The service volume of a Ground Station is the geographic scope of responsibility the Ground Station assumes for each product broadcast.

The UAT system uses time division multiplexing for Ground Uplink Messages to allow multiple Ground Stations to operate on the same frequency. At the designer's disposal are the 32 time slots within the Ground Segment of the UAT frame. Since time slots must be re-used geographically, there is a potential for self-interference where radio coverage is greater than the designed minimum. The allocation of one or more time slot resources to a given Ground Station based on some re-use pattern will mitigate this self-interference.

As an example of assigning service volumes, a hexagonal “cellular” pattern of Ground Stations with a nominal intersite spacing of 100 NM would assure single coverage everywhere down to about 3000 feet above ground level (AGL). (This is based on a 4/3 earth refraction model, a nominal antenna height of 50 feet, and ignores terrain effects.) This intersite spacing would require each Ground Station to have a service volume of radius of about 58 NM. A longer range may be specified if additional overlapping coverage is desired. A nominal coverage cell layout is shown in Figure 6-1. In this example case, the service volume has a radius of 58 NM. As discussed below different uplink products broadcast by a Ground Station may cover different geographical areas, called *product coverages*, than the Service Volume of that Ground Station.

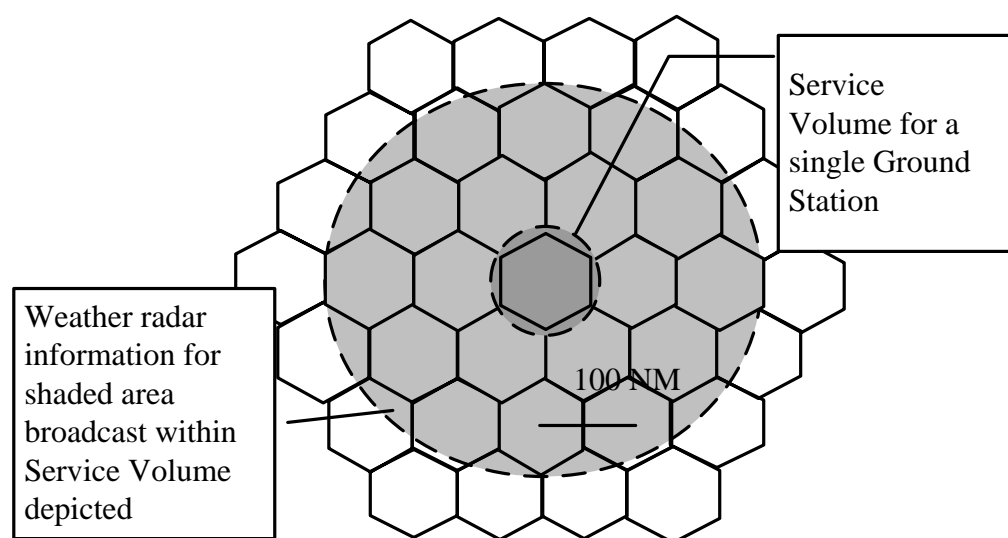

Figure 6-1: Example Coverage Cell Layout

6.1.1.1.1 FIS-B Product Coverage

The FIS-B product coverage and update rate can be tailored to suit the characteristics of the particular FIS-B information being broadcast. For example, information that is relatively small in terms of total data volume and that is updated infrequently such as Automated Terminal Information Service (ATIS) messages could have a relatively large product coverage (e.g., a circle of diameter 500 NM) and a relatively low update rate. The FIS-B product coverage of, e.g. a weather map, could exceed the service volume of a single Ground Station.

If an aircraft receives FIS-B uplinks from multiple UAT Ground Stations, it may combine these data. This task can be minimized by having the ground infrastructure assure that product information from different Ground Stations for the same geographical location is identical. For example, adjacent uplink stations reporting precipitation strength for a given point or grid element should report exactly the same data. Then the application in the aircraft need only associate the reports and choose either for displaying or processing (rather than averaging, interpolating, or inferring data integrity). Note that with autonomous, isolated Ground Stations this is not an issue.

Looking back at Figure 6-1, a sample product coverage is shown along with the service volume for a single cell. For this product coverage, there is a consistent picture of the product as the aircraft flies through the lightly shaded region depicted.

6.1.1.1.2 TIS-B Product Coverage

A product such as traffic data (TIS-B) calls for a higher update rate than FIS-B, which results in a smaller product coverage area to keep UAT data link uplink requirements at a reasonable level. TIS-B product coverage overlap between adjacent Ground Stations should be just enough to assure service continuity across the boundary. This approach keeps the load on the data link as low as possible and minimizes the burden on the ADS-B Receiving Subsystems to eliminate redundant reports.

6.1.1.2 Data Source for Ground Broadcast

Contents of the ground broadcast messages can be put in the following categories:

1. Flight Information Services-Broadcast (FIS-B) – the broadcast distribution of weather and aeronautical information.
2. Traffic information from other surveillance sources (radar, multilateration) – this augments the ADS-B data received directly from the air-to-air link.
3. ADS-B data collected from non-UAT links.
4. Other.

In the UAT data link, FIS-B and “other” information is sent during the ground broadcast segment. Traffic uplink (TIS-B) data can be sent during the air-to-air segment of the UAT epoch in a form similar to the air-to-air format or during the ground segment in a special uplink format.

There are many possible configurations for the flow of information for the uplink stations. Not all stations need to be configured the same way. The one chosen will depend on the products being provided. In any case, the UAT equipment is a minor part of the ground system. The system will be primarily defined by the ground communication links (satellite, land line (phone, fiber) or microwave or other dedicated RF link), by the sources of the data for ground broadcast (radar, multilateration, weather observation and forecast), and by the applications that fuse this data and generate the ground broadcast reports.

6.1.2 Downlink: Surveillance

ADS-B data being transmitted by aircraft will be received (in general) at multiple ground receiving stations. This redundancy is readily fused since all stations are receiving the same message contents. Because of the required frame synchronization of all UAT transmitters and receivers, there is ample accuracy in the time-of-arrival stamp on each message to readily associate them and merge them. No averaging or weighting need be done on the contents as they are all the same.

A rough range from the receiving station can be determined from the Transmission Epoch (MSO number) inferred by the receiver or actually provided in some ADS-B Messages (see Section 5.5). A very accurate time stamp on arrival and a more accurate receiver synchronization would allow multilateration on ADS-B reports received at multiple Ground Stations. Either method of independent position verification can be used in a health monitoring check on the down-linked ADS-B reports (e.g., a check of the on-board GPS equipment in the aircraft).

6.1.3 Summary of Infrastructure and Implications

Figure 6-2 shows a generalized diagram of the components and interconnect of a ground infrastructure for the UAT data link. Many variations of this general structure are possible. Transmitters and receivers may or may not be co-located. Different sites may have different levels of service.

A considerable transition time period to full ADS-B equipage will need to be supported, and the UAT data link has the necessary flexibility to provide such support. Because of the generality of the data link, the system can be expanded as the ground infrastructure is developed and “filled in.” The UAT Ground Station is adapted to each specific deployment by the application(s) driving it.

The characteristics of the UAT link required to support this general structure are in the areas of time stamps and predictable latency, one second frame synchronization, time division coordination of adjacent ground cells, and a waveform tolerant of self-interference.

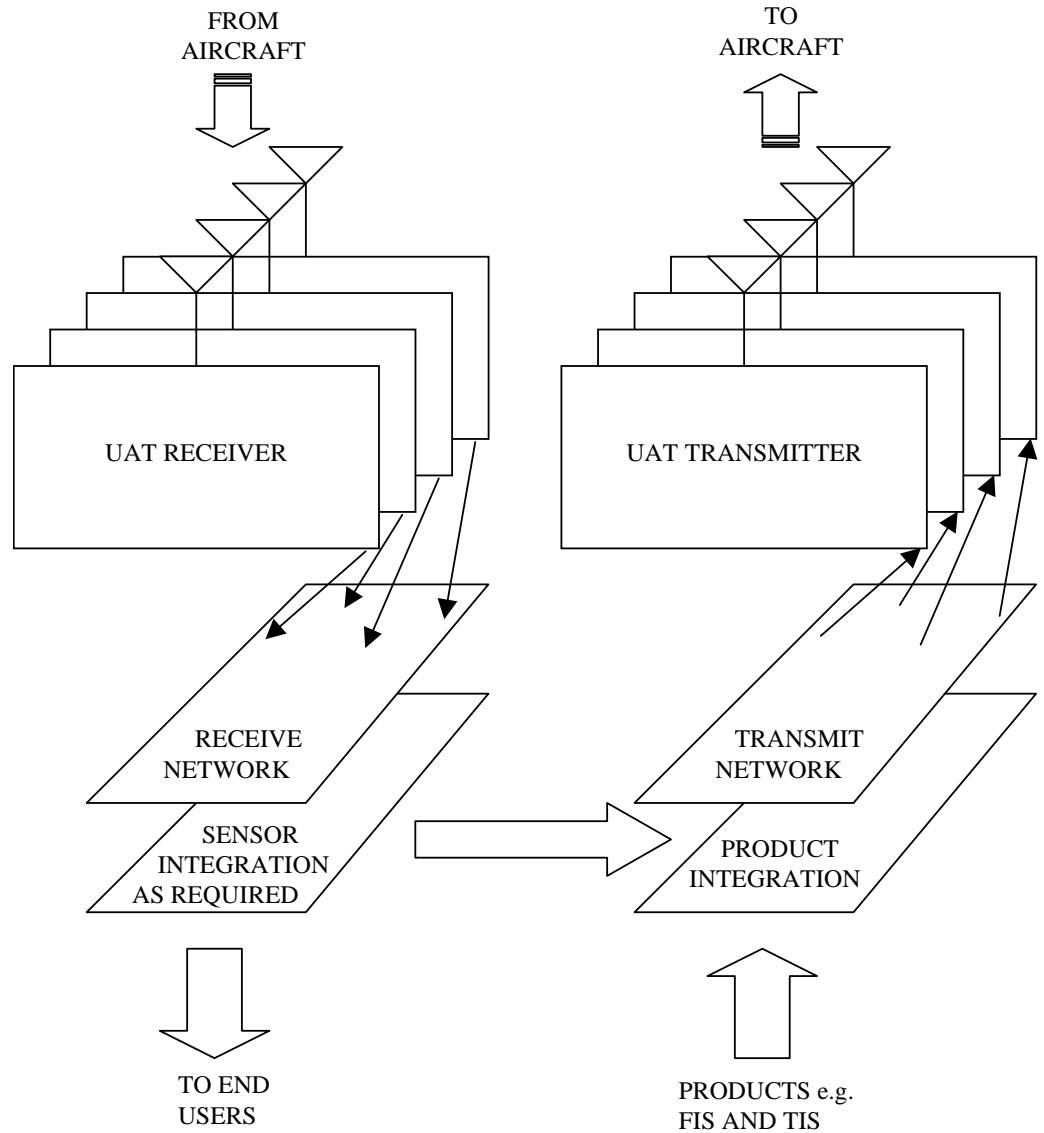

Figure 6-2: General Form of Ground Infrastructure

6.2 Ground Station Deployment

6.2.1 Time Slots and “Data Channels”

The UAT data link has 32 uplink time slots available within the Ground Segment of the UAT frame. As described in §3.2.2 of the UAT Manual on Detailed Technical Specifications, this results in 32 data channels, where each data channel represents the incremental resource that can be assigned to Ground Station transmitters so they can operate without mutual interference. That is, a “Data Channel” is a time slot sized resource assignable to a Ground Station where the actual time slot used shifts on a continual basis per a defined time slot rotation scheme. One or more Data Channels may be assigned to any given UAT Ground Station.

One or more Data Channels assigned to a UAT Ground Station is the station's "Data Channel Block" (DCB). A conservative approach to forming DCBs is to give one data channel to each Ground Station. In a hexagonal deployment using this conservative approach, the nearest station using the same Data Channel as a given station will on average be about 6 cell diameters away.

In practice, it will be desirable for each DCB to contain multiple Data Channels. This will allow the uplink bandwidth necessary for each Ground Station to deliver its entire product. An assignment of Data Channels to one of 7 distinct DCBs (A – G) will meet this objective by allowing cells that re-use a given DCB to be separated by about 2.5 cell diameters as shown in Figure 6-3 below.

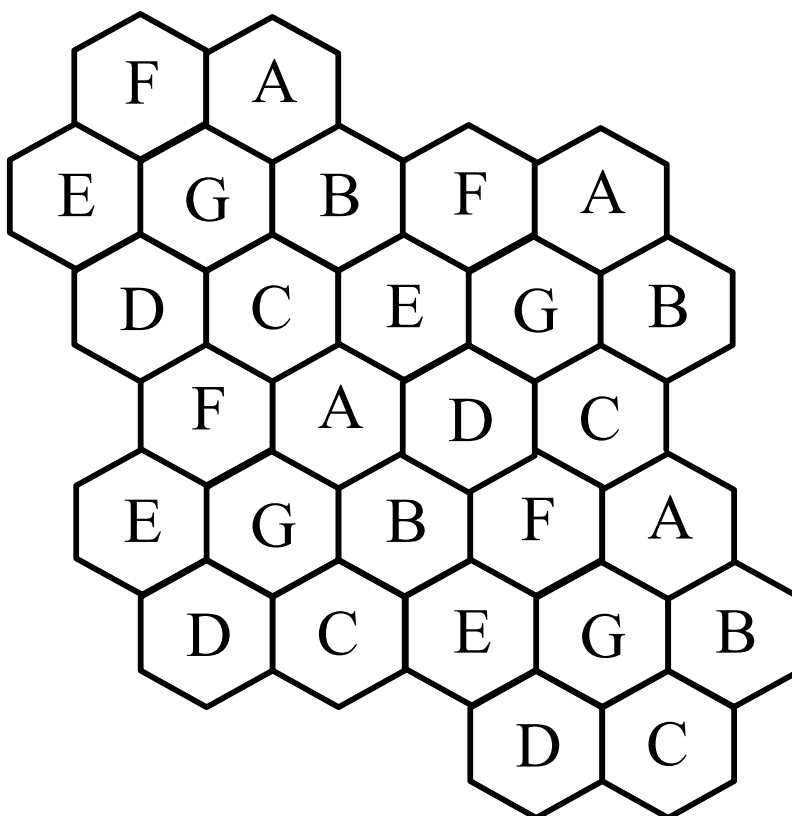

Figure 6-3: 7-Data Channel Block Re-Use Pattern

Note: *The Data Channel Block re-use pattern of Figure 6-3 is provided for illustrative purposes and is suitable for providing services within a limited altitude range. A possible approach that covers a wide range of altitudes is discussed in Section 7.3.*

6.2.2

Antenna Considerations for Uplink

Considering the cell re-use described above, the possibility arises for self-interference with the UAT signal. The Ground Uplink Message can readily be received in self-

interference if the interference is sufficiently below the desired signal level. The required ratio depends on the target density and distribution. The two figures below show a self-interference analysis for the following set of Ground Station assumptions:

- 7 cell re-use pattern
- 90 NM inter-site spacing of Ground Stations
- 10 dB desired/undesired signal ratio for successful receipt of Ground Uplink Messages (this figure does not take into account antenna pattern variations for the desired and undesired signals at the receiving aircraft).

Each figure shows two sets of seven cells in a repeating reuse pattern as in Figure 6-3. Consider the two cells labeled “G” sharing data channel resources. The shaded area in each figure represents the area where *neither* Ground Station can be successfully received because of the fact that the signal strength ratio between the desired and undesired station falls below 10 dB. The curved arcs are the line-of-sight limits for a 40,000 foot target for each “G” station.

Figure 6-4 is the interference analysis using low gain Ground Station antennas much like those on aircraft. The shaded area confines itself to the area between and outside of the cells of interest. This is of no harmful consequence, as the other Ground Stations cover the area in between with non-interfering time slots.

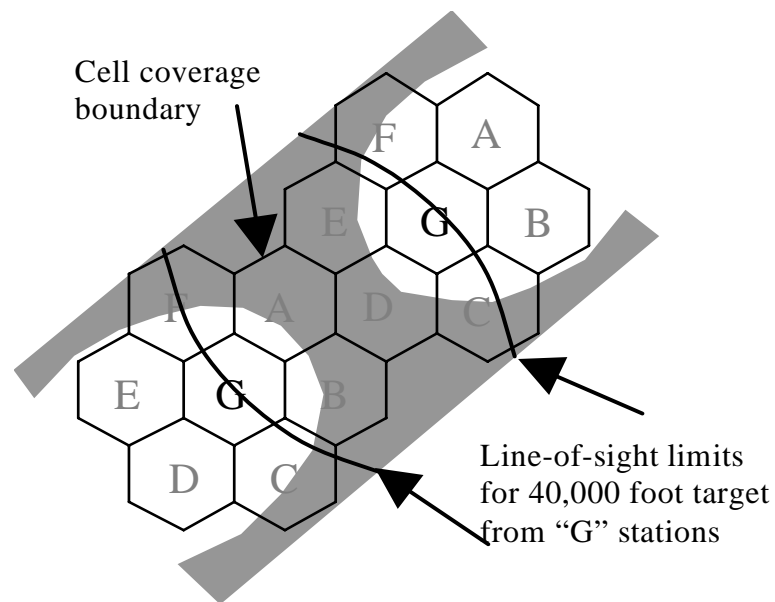

Figure 6-4: Self-Interference with Low-Gain Antenna

Figure 6-5 shows the results of the same analysis except that the transmit antenna is a Ground DME Antenna Type-10153 made by JTP Radiation Inc., which has a higher gain on the horizon but nulls at higher elevations. There is an additional shaded region within each “G” cell due to the stronger signal from the distant site and the null at the desired site. The use of the DME antenna for ground reception is beneficial to get gain on long-range targets, but for transmit the interference produced by the far sites is harmful.

This specific example shows that care must be taken in the selection of the transmit antenna with respect to the Ground Station density to avoid substantive self-interference. An antenna with nulls that are less deep is desirable. Another approach is to space the cells and allocate cell re-use such that the nearest interfering station is over the horizon for targets within the service volume of the Ground Station.

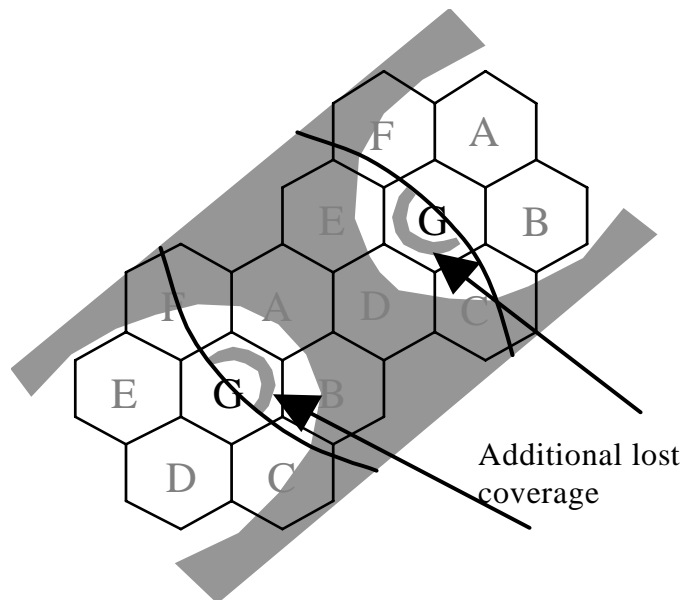

Figure 6-5: Self-Interference with DME-Type Antenna

6.2.3 TIS-B Site Identifier (ID)

Each station is assigned a TIS-B Site ID number (UAT Manual on Detailed Technical Specifications §2.2.1.8). This number is not unique, having only a 4-bit value. The purpose of the ID is to give a brief (few bits) way of identifying the source of a TIS-B uplink message. This source identification is useful for confidence measures of time synchronization and to counteract spoofing. In low-density areas, only one station with a given ID will be within reception range. In more dense areas, more than one Ground Station can be received (but not a large number) with the same ID and any range checking can be performed, using uplinked Ground Station locations, on all stations with that ID to get verification.

As an example, consider a 7-cell reuse pattern of Data Channels. Figure 6-6 shows an assignment of 7 of the 32 Data Channels (labeled A through G) and of the 15 TIS-B Site ID numbers (labeled 1 through 15). To see the repeat pattern in this example, look at a cell with slot label “G” as the center of a 7-cell cluster. A through F are clockwise around it. These clusters are then packed hexagonally. This is just an illustrative example to demonstrate the idea.

The approximate reception area of an aircraft is shaded in Figure 6-6. The aircraft’s trajectory is shown by the arrowed line and the swath of the reception area is shown by the dotted lines. During the Ground Uplink Segment, the aircraft is solidly receiving data in Data Channels A, B, D, and E (labeled A9, B14, D10, and E5). The aircraft can tell

that these stations are within a normal reception range based on the location broadcast in the uplink.

Table 6-1 shows a list of these locations and TIS-B Site ID's as they can be kept in the aircraft's ADS-B application. The aircraft receives uplinks on a given slot possibly from two different G Ground Stations (G13 and G6). The storage in a table of the locations of these Ground Stations permits the use of the range validation technique described in section **Error! Reference source not found.** Entries can be dropped from the table when they are beyond range by some pre-determined amount. At the time shown, there are also two entries in the table with TIS-B Site ID 4 as well as two entries with TIS-B Site ID 8. Note that the Data Channel indicator (labeled A-G) in the table is for clarity of the example only. Retaining a Data Channel identifier is not important for the range validation technique or for any Ground Station function once propagation time has been computed.

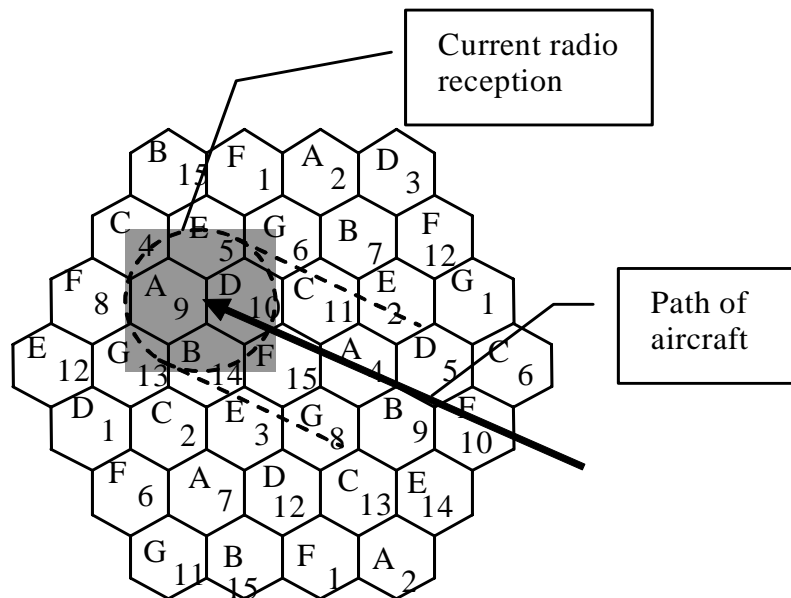

Figure 6-6: Example of TIS-B Site ID and Data Channel

Table 6-1: Example of Site ID Table

TIS-B Site ID	Location	Data Channel
9	lat long	A
14	lat long	B
4	lat long	C
10	lat long	D
5	lat long	E
13	lat long	G
6	lat long	G
8	lat long	F
15	lat long	F
11	lat long	C
2	lat long	E
4	lat long	A
8	lat long	G

Each of these Ground Stations transmits TIS-B messages in the ADS-B Segment of the UAT frame. Since these are in random MSO's, they can all be received with high probability. In addition, other more distant stations can transmit TIS-B messages and be received. When any TIS-B message arrives with its Site ID (0-15), its apparent distance from the aircraft (from the time-of-arrival) can be checked with *all* entries in the table having that Site ID. If it matches, that message is validated. If not, it can be rejected as unreliable.

It is possible that a legitimate TIS-B message can be rejected from a distant station based on this method, if the station is not on the list. This is not a problem because if the target is important to the aircraft it will be included in the TIS-B uplinks of a nearer station giving good range validation checks. This can be assured by the design of the product coverage for each cell.

6.2.4 Sectorized Cells and Co-Site Transmission Isolation

In some areas of dense air traffic, a Ground Station at maximum range can experience poor ADS-B target state update performance due to UAT self-interference. In this event, the area of air-ground reception might be reduced, but it is undesirable to have multiple equipment sites to cover the range. An alternative solution to this problem is to co-locate several units with sectorized antennas.

In cases where UAT ground equipment is co-located with other transmitting equipment at a nearby frequency (e.g. a DME/TACAN installation at 979 MHz,) it is desirable to get as much rejection of that interfering signal as possible. In these cases, the same sectorized antenna mentioned above can also help. Section 6.3 discusses the required signal rejection in cases of interference.

Figure 6-7 shows a pattern for a 3-sector UAT Ground Station antenna. The solid curve is one sector and the dashed curves are the other two sectors. This pattern is representative of a DME-type column antenna with a reflector behind it to shape the

pattern and block the backlobe. Figure 6-8 shows two possible geometries that will produce isolation between co-sited DME equipment and UAT equipment. The required isolation will depend on the power of the DME equipment and the desired maximum signal level of the interference at the UAT equipment. Sections B.4.1 and B.4.2 in Appendix B discuss performance with various scenarios of DME/TACAN interference. For a low-density scenario and a DME at 979 MHz, the UAT equipment can tolerate a DME level of -30 dBm. In a future Core Europe scenario, for example, the tolerable level is -50 dBm. This is discussed further in §6.3.2.

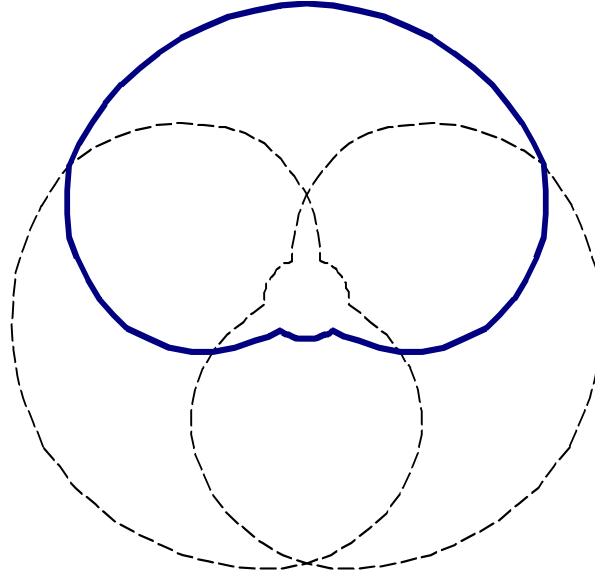

Figure 6-7: Sectorized Antenna Pattern (3 sectors)

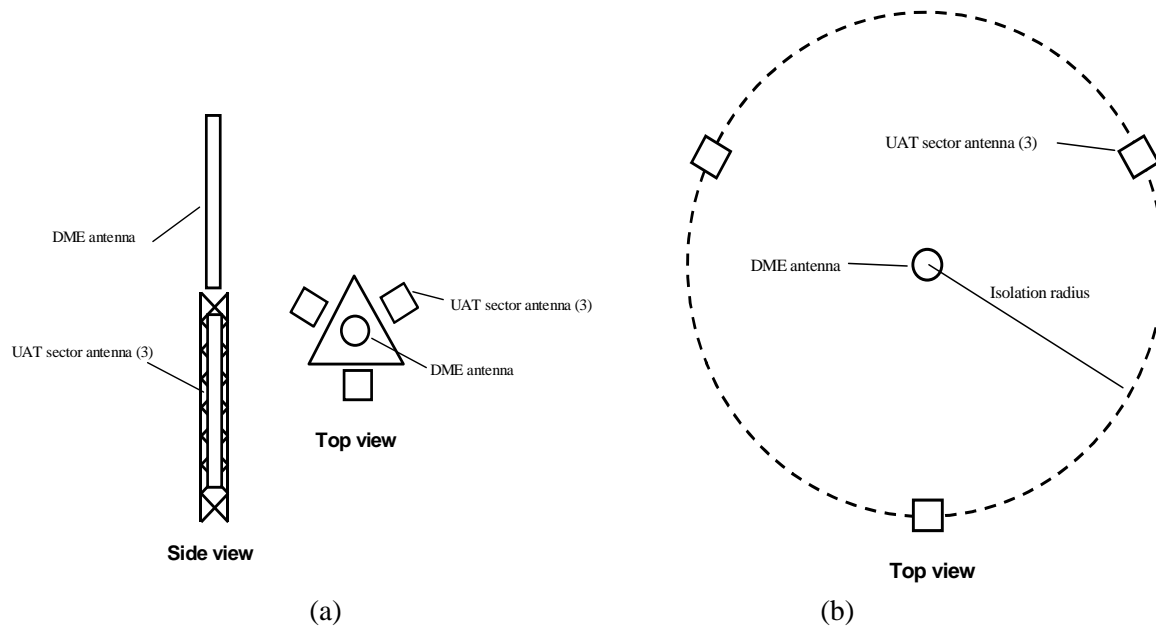

Figure 6-8: Possible UAT Ground Station Antenna Geometries

6.3 RF Interference

There are two primary sources of interference from other systems at the UAT operational frequency of 978 MHz: JTIDS (Link 16) and DME. There has been a considerable amount of analysis, simulation, and laboratory measurement to determine the working limitations of UAT with these other two systems. Most of the issues occur with DME equipment and are discussed below.

6.3.1 JTIDS Interference

The mutual effects of JTIDS and UAT are discussed in Appendix D. In short, between the spread spectrum nature of JTIDS and the interference rejection of the UAT modulation, the systems operate compatibly.

6.3.2 DME Interference

An important source of interference to the UAT link operating at 978 MHz is DME equipment operating near that frequency. UAT/DME frequency planning criteria to support future high-level UAT environments specify that the closest assignable DME Ground Station transmitting frequencies relative to the UAT frequency of 978 MHz are the first adjacent DME frequencies.

Siting criteria for UAT Ground Stations in the presence of DME/TACAN transponders operating at 979 MHz and above, are contained in Section 7.2.

There are a number of techniques that may be used to mitigate the effect of high DME signal levels on a collocated UAT Ground Station Receiver. If the UAT Ground Station is using sectorized antennas (Section 6.2.4) a 25 dB attenuation of the DME signal may be achieved by locating the DME antenna in the UAT antenna backlobe. Vertical stacking of the antennas may yield even more isolation. The UAT air-to-ground performance is ultimately a function of the interfering signal level.

Other possible techniques to achieve the necessary isolation are a very sharp (e.g. tuned cavity) filter, or adaptive cancellation on the UAT Ground Station. In the case of a filter, the approach would be to find a filter for the UAT receiver with acceptable in-band loss for the desired sensitivity to be achieved and then use the 979 MHz rejection of the filter to ease the burden on the antenna separation. A representative filter will give less than 5 dB of in-band (insertion) loss while rejecting the out-of-band (979 MHz) interference by 40 dB. This net benefit of 35 dB is available if the insertion loss can be tolerated by the receiver sensitivity and the intended range of the Ground Station.

In the case of adaptive cancellation, an auxiliary array can be positioned to sample the interferer signal or it can be delivered by a direct connection. The system can then adaptively subtract a replica of this sample from the received UAT signal to achieve the best signal-to-interference ratio. This approach requires considerable equipment expense, but may be economical in difficult siting situations if it avoids needing additional sites.

In environments where the co-located DME is at 980 MHz (or higher frequencies) instead of 979 MHz, the above isolation techniques are not likely to be necessary, provided that the DME and UAT Ground Stations are separated as recommended in Section 7.2.

6.4 Multiple ADS-B Links

ADS-B in high air-traffic density airspaces may use multiple ADS-B data links. Through its support of ADS-B re-broadcast, the UAT data link is capable of supporting a multi-link deployment. Power levels and antenna locations are specified such that air-air as well as air-ground links are established over appropriate service volumes. This allows information on any non-UAT ADS-B traffic to be obtained by the ground infrastructure and supplied to UAT-equipped aircraft.

7 UAT Frequency Planning Criteria

As previously discussed, the UAT frequency is centered at 978 MHz with a nominal bandwidth of 1 MHz. UAT/DME frequency planning criteria to support future high-level UAT environments will specify that the closest assignable DME Ground Station transmitting frequencies relative to the UAT frequency of 978 MHz are the first adjacent DME frequencies.

7.1 Use of 978 MHz for DME/TACAN

Co-frequency operation of UAT and DME/TACAN is not recommended. Test, simulation and analysis have shown that UAT and co-frequency DME could be operated on a compatible basis when both the number of DME stations in view to UAT airborne receivers is limited, and the density of UAT transmitters is low. Further analysis would be required to establish appropriate parameters for co-frequency operation. It should be noted however that the use of 978 MHz for DME ramp test equipment can still be supported, as the characteristics of the operational interaction scenario for UAT-to-ramp tester serves to preclude interference.

7.2 DME/TACAN to UAT Ground Station Siting Criteria

Extensive testing has indicated no operationally significant impact to DME/TACAN in a high density UAT environment when DME/TACANs are receiving on the first upper adjacent DME frequency (979 MHz) to the UAT frequency (978 MHz). A similar result can be inferred for DME reception at the lower first adjacent frequency of 977 MHz. Analysis of an example approach/landing scenario in Core Europe 2015 has shown that first adjacent frequency DME operation is also compatible with an environment that includes a nearby UAT Ground Station broadcasting at a high duty factor.

Any limitations on the siting of UAT Ground Stations vis-à-vis DME/TACANs are likely to result from the effects of DME/TACAN transmissions on UAT performance. This question has been studied by examining UAT performance with a first upper adjacent frequency DME/TACAN Ground Station co-located with a UAT Ground Station receiver at a high density airport. Air-air, ground-air, air-ground, and surface-surface performance were studied. The result of the combined analysis of these cases is a recommendation that a sufficient level of isolation be provided between a DME/TACAN transmit antenna and a UAT receiver on the surface. This could be supplied through either separation by distance or some other means, and the amount of isolation required depends on the parameters of the DME/TACAN and the design of the UAT receive system.

For example, to provide a performance level sufficient to allow for the air-ground reception requirement to be met to 150 NM for Class A0-equipped aircraft in high density Core Europe 2015 in the presence of a co-located DME/TACAN, Table 7-1 and Table 7-2 show the trade-off between distance from the UAT ground receiver and transmit power for a 979 MHz DME/TACAN. For the assumptions used in this analysis, see Appendix B.

Table 7-1: Maximum Power of a 979 MHz DME/TACAN for a given Separation Distance to a UAT Ground Station Receiver

For a DME/TACAN-UAT Distance of:	Maximum DME/TACAN EIRP (W)
2 NM	10,000
1 NM	2,500
0.5 NM	625
0.25 NM	157

Table 7-2: Minimum Distance of a UAT Ground Station Receiver to a 979 MHz DME/TACAN

For a DME/TACAN EIRP (W) of:	Minimum Distance
10,000	2 NM
5,000	1.4 NM
1,000	0.63 NM
500	2700 ft.

The distance between the UAT Ground Receiver and a DME/TACAN transponder should be such that the power of the DME/TACAN transmission received by the UAT Ground Receiver is less than -30 dBm at the PMP. This provides for air-ground reception which supports surveillance up to 150 NM for all aircraft transmit power levels.

Note: *This statement is based on analysis performed for a high density Core Europe 2015 air traffic scenario (as described in Appendix B), with a UAT Ground Station receiving signals from 980-1213 MHz DME/TACAN transponders.*

8 Guidance on UAT Spurious Emissions

8.1 ITU Regulations

The ITU Radio Regulations require that the bandwidths of emissions be such as to ensure the most efficient utilization of the radio spectrum. In general this requires that bandwidths be kept at the lowest values which the state of the art and the nature of the radio service permits. Emission outside the necessary bandwidth is called the unwanted emission and consists of out-of-band and spurious emissions. Out of band emissions are the main component of the unwanted emissions close to the fundamental emission, and the spurious emissions become dominant further from the fundamental emission. The out-of-band and spurious domains are characterized by the type of unwanted emissions which are predominant, the boundary between the domains is determined is generally 2.5

times the necessary bandwidth, but with certain exceptions. Guidance on these exceptions is given in Recommendation ITU-R SM.1439.

ITU Radio Regulations contain the following definitions:

1.144 Out-of-band emission: Emission on a frequency or frequencies immediately outside the necessary bandwidth which results from the modulation process, but excluding spurious emissions.

1.145 Spurious emission: Emission on a frequency or frequencies which are outside the necessary bandwidth and the level of which may be reduced without affecting the corresponding transmission of information. Spurious emissions include harmonic emissions, parasitic emissions, intermodulation products and frequency conversion products but exclude out-of-band emissions.

1.146 Unwanted emissions: Consist of spurious emissions and out-of-band emissions. (Note: Both out-of-band and spurious emissions occur outside the necessary bandwidth of an emission).

1.152 Necessary bandwidth: For a given class of emission, the width of the frequency band which is just sufficient to ensure the transmission of information at the rate and the quality required under specified conditions.

Figure 8-1 provides a pictorial representation of the above terms.

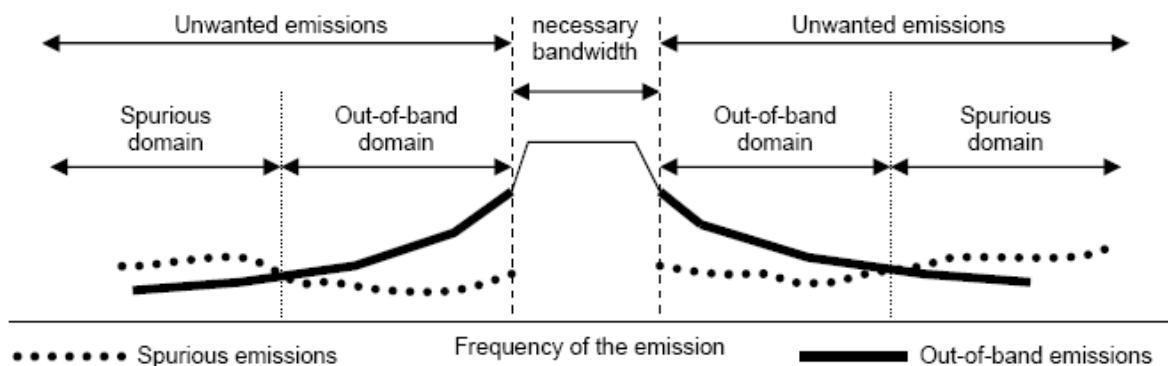

Figure 8-1: Unwanted Emissions and necessary Bandwidth

Attenuation values used to calculate maximum permitted spurious domain emission power levels for use with radio services are defined in the ITU Radio Regulations, Appendix 3, Section II as well as the Recommendation ITU-R SM.329-9 for transmitters installed after 1 January 2003 and all transmitters after 1 January 2012.

The spurious emission levels are specified in the following reference bandwidths:

- 1 kHz between 9 kHz and 150 kHz
- 10 kHz between 150 kHz and 30 MHz
- 100 kHz between 30 MHz and 1 GHz

- 1 MHz above 1 GHz.

A UAT transmitter installed after 1 January 2003 must meet a spurious domain emission attenuation of $43 + 10 \log (P)$, or 70 dBc, whichever is less stringent (where P is the mean power in Watts supplied to the antenna transmission line).

Recommendation ITU-R SM.329-9 also provides guidelines on the frequency range within which unwanted emissions need to be measured. For transmitted frequencies between 600 MHz and 5.2 GHz, the lower measurement limit should be 30 MHz and the upper limit is (including) the 5th harmonic.

8.2 Example Application of the ITU Regulation to the UAT Case

Information received from the ITU indicates that the two main functions of the UAT system (ADS-B and ground uplink) belong to different radio services. The ADS-B part of UAT is considered as an Aeronautical Radionavigation Service (ARNS) whereas the UAT ground uplink part needs to be treated as an Aeronautical Mobile (R) Service.

With a maximum total mean power of 500 W¹ supplied by a UAT transmitter to the antenna transmission line, the attenuation relative to the total mean power equals $43 + 10 \log (500) = 70$ dBc. Therefore, the spurious emissions supplied by a UAT transmitter to the antenna transmission line of maximum power UAT transmitters must not exceed $57 \text{ dBm} - 70 \text{ dBc} = -13 \text{ dBm}$. That spurious emission level is to be measured with a 100 kHz reference bandwidth for spurious emissions in the frequency range 30 – 1000 MHz and with a 1 MHz reference bandwidth for spurious emissions at frequencies above 1000 MHz.

In the case of UAT, a necessary bandwidth of 1.3 MHz (equal to the measured occupied – i.e., 99% power -- bandwidth) has been assumed. Therefore the boundary between spurious and out-of-band emissions is set to $2.5 * 1.3 \text{ MHz} = 3.25 \text{ MHz}$. With a UAT carrier frequency of 978 MHz, the spurious emission domain is located at frequencies below 974.75 MHz and above 981.25 MHz.

The requirements for the spurious domain for UAT cover the frequency band 30 MHz to $5*978=4890$ MHz excluding the fundamental emission and the out-of band domain (974.75 MHz to 981.25 MHz).

The UAT SARPs, §12.1.2.3.3 "Transmit Mask" states: "The spectrum of a UAT message transmission modulated with pseudorandom payload data shall fall within the limits specified in Table 2 when measured in a 100 KHz bandwidth." At frequencies off-tuned by 3.25 MHz (where the spurious domain starts), UAT signal components should be attenuated by at least 60 dB compared to the UAT signal at 978 MHz (measured in a 100 KHz bandwidth). Therefore, Figure 1 of the UAT SARPs has to be interpreted for a maximum power UAT transmitter as if that maximum power at 978 MHz (i.e., 57 dBm measured in a 1.3 MHz bandwidth) equals approximately 47 dBm per 100 KHz. At 3.25 MHz offset, the mask requires the emission to be 60 dB less (i.e. -13 dBm per 100 KHz).

¹ The UAT SARPs specify a maximum power of 54 dBm at the PMP. Assuming a 3 dB feeder line loss, the maximum UAT transmitter output power will be 57 dBm (500 W).

Hence, the transmit mask of the UAT SARPs is consistent with the spurious emissions requirements of the ITU Radio Regulations even for the maximum UAT transmit power levels. It is important to note that the mask is more conservative than the ITU spurious emission requirements for lower UAT transmit power levels¹.

8.3 Conclusion

The transmit mask in the UAT SARPs will ensure that the ITU spurious emission requirements are met at the out-of-band/spurious emission boundary.

Spurious emissions should be measured in a reference bandwidth of 100 KHz in the frequency band 30 MHz to 974.75 MHz and 981.25 to 1 GHz, and in a reference bandwidth of 1 MHz in the frequency band of 1 GHz to 4.890 GHz.

9 Potential Future Services of UAT

Some potential future services for UAT-equipped aircraft are described in this section. The services identified here support position determination of UAT-equipped aircraft based on Time of Message Reception (TOMR) of UAT signals. The services are listed below:

1. Range validation of ADS-B reported position data, based on the one way propagation time of the ADS-B Message. This function can be performed by a single receiving station and relies on both the transmitter and receiver having access to precise timing information (referred to as being in the “UTC coupled” condition). This is useful mainly to attain some confidence the ADS-B transmission is from a bona fide user and is not a result of “spoofing”. Further information on this potential future service can be found in Appendix K.
2. Localization of a mobile ADS-B transmitter from a fixed ground receiver network. This function requires reception of the ADS-B Message by at least 3 Ground Stations. Each Ground Station requires precise knowledge of time in order to provide the TOMR with each reception. The TOMR allows a central processor to localize the transmitter via the time-difference-of arrival technique. The mobile transmitter does not require knowledge of its own position nor does it require precise knowledge of time. This capability—coupled with the reported identification and barometric altitude—could provide *backup air-ground surveillance* in the event of widespread outage of GNSS, presuming that the Ground Station time source is independent of GNSS and accurate to within 500 nanoseconds of UTC.
3. Localization of the mobile (ownership) ADS-B receiver. This is based on reception of 3 or more Ground Station “beacon” transmissions within the same UTC second. Each Ground Station beacon transmission is based on precise knowledge of time. The ownership UAT receiver need not have precise knowledge of time, but determines position from the time-difference-of arrival technique and knowledge of the ground beacon locations encoded in the received messages. This capability could provide a

¹ For example, in the case of a 50 watt UAT, the spurious emission limit is $43 + 10\log(50) = 60$ dBc, or 47 dBm – 60 dB = -13 dBm. The mask however requires the emission at the out-of-band/spurious boundary to be 60 dB down from approximately 37 dBm (i.e., the portion of the 50 watt 1.3 MHz UAT emission that is measured in a 100 kHz measurement bandwidth) or -23 dBm.

crude form of *backup navigation* in the event of widespread outage of GNSS, presuming that the Ground Station time source is independent of GNSS and accurate to within 500 nanoseconds of UTC.

Table 9-1: Summary of Potential Future Applications of UAT

Potential Future UAT Service	UAT Transmitting Subsystem Requirements	UAT Receiving Subsystem Requirements	Primary Application	Limitations
Range Validation	Navigation input, UTC Coupled	Navigation input, UTC Coupled	Integrity check of ADS-B	Total timing errors limit range accuracy to ~ 0.7 NM (see Error! Reference source not found.)
Backup Air-Ground Surveillance	None	UTC Coupled	Surveillance backup for GNSS	Service available only in areas of significant Ground Station infrastructure
Backup Navigation	UTC Coupled (stable source can operate without GNSS for hours)	None	Navigation backup for GNSS	Service available only in areas of significant Ground Station infrastructure

Appendix A

Acronyms & Definition of Terms

Comparison Source – ICAO Document 9713, “International Civil Aviation Vocabulary”, Parts 1 and 2, Second Edition, 2001.

NOTE:

- Reference in brackets [Xxxx] indicates ICAO subject field.
-

This page intentionally left blank.

A. Acronyms & Definition of Terms

A.1 Acronyms

ACAS – Airborne Collision Avoidance System [A284]

ADS-B - Automatic Dependent Surveillance-Broadcast [A729]

AGL - Above Ground Level

APDU – Application Protocol Data Unit

A/V - Aircraft/Vehicle

ATC - Air Traffic Control [A439]

ATCS - Air Traffic Control Services [A284]

ATIS - Automatic Terminal Information Service

CDTI - Cockpit Display of Traffic Information [C245]

dB – Decibel

dBm – Decibel with respect to 1 milliwatt

DME - Distance Measuring Equipment [D185]

EPU - Estimated Position Uncertainty

E/W – East/West

ERP - Effective Radiated Power

FEC – Forward Error Correction [F205]

FIS-B - Flight Information Services-Broadcast

FMS - Flight Management System [F138]

f_0 – Nominal or Center Frequency

GNSS - Global Navigation Satellite System [G56]

GPS - Global Positioning System [G60]

HFOM – Horizontal Figure of Merit

Hz - Hertz [H48]

ICAO - International Civil Aviation Organization [I234]

INS - Inertial Navigation System [I95]

JTIDS – Joint Tactical Information Distribution System (also known as Link 16)

kHz – KiloHertz

LSB - Least Significant Bit [L62]

MASPS - Minimum Aviation System Performance Standards

Mbps – Million Bits Per Second

MDB – Message Data Block

MDBS – Message Data Block Selection

MHz - Megahertz

MIDS – Multifunctional Information Distribution Systems

MOPS - Minimum Operational Performance Standards [M163]

MS - Mode Status

MSL - Minimum Signal Level

MSO – Message Start Opportunity

NM - Nautical Mile [\[N14\]](#)

N/S – North/South

NAC_P - Navigation Accuracy Category - Position

NAC_V - Navigation Accuracy Category - Velocity

NIC_{baro} - Navigation Integrity Category - Barometric

PMP - Power Measurement Point

PPM – Parts Per Million [\[P62\]](#)

PPS – Pulse Per Second

RA - Resolution Advisory [\[R216\]](#)

R_C – Radius of Containment

RF - Radio Frequency

RNP - Required Navigation Performance [\[R192\]](#)

RS - Reed-Solomon Code [\[R110\]](#)

SA - Selective Availability [\[S111\]](#)

SARPs - Standards and Recommended Practices [\[S282\]](#)

SSR - Secondary Surveillance Radar [\[S81\]](#)

TA - Track Angle

TACAN - [UHF](#) Tactical Air Navigation Aid [\[U1\]](#)

TCAS - Traffic Alert and Collision Avoidance System

TCR - Trajectory Change Report

TIS-B - Traffic Information Service-Broadcast

TOMR - Time of Message Receipt

TOMT – Time of Message Transmission

TS – Target State

UAT – Universal Access Transceiver

US - United States

UTC - Co-ordinated Universal Time [\[C469\]](#)

VFOM – Vertical Figure of Merit

WGS-84 - World Geodetic System 1984

A.2 Definition of Terms

Accuracy - A degree of conformance between the estimated or measured value and the true value. Note. – For measured positional data the accuracy is normally expressed in terms of a distance from a stated position within which there is a defined confidence of the true position falling. [A41] With specific reference to UAT, a measure of the difference between the A/V position reported in the ADS-B message field as compared to the true position. Accuracy is usually defined in statistical terms of either 1) a mean (bias) and a variation about the mean as defined by the standard deviation (sigma) or a root mean square (rms) value from the mean. The values given in this document are in terms of the two-sigma variation from an assumed zero mean error.

ADS-B Broadcast and Receive Equipment - Equipment that can transmit and receive ADS-B messages. Defined as Class A equipment.

ADS-B Broadcast Only Equipment - Equipment that can transmit but not receive ADS-B messages. Defined as Class B equipment.

ADS-B Message – A modulated packet of formatted data which conveys information used in the development of ADS-B reports.

ADS-B Report – Specific information provided by the ADS-B user participant subsystem to external applications. Reports contain identification, state vector, and status/intent information. Elements of the ADS-B Report that are used and the frequency with which they must be updated will vary by application. The portions of an ADS-B Report that are provided will vary by the capabilities of the transmitting participant.

ADS-B Subsystem - The set of avionics or equipment that performs ADS-B functionality in an aircraft or for ground-based, non-aircraft, participants.

ADS-B System - A collection of ADS-B subsystems wherein ADS-B messages are broadcast and received by appropriately equipped participant subsystems. Capabilities of participant subsystems will vary based upon class of equipage.

Advisory - An annunciation that is generated when crew awareness is required and subsequent crew action may be required; the associated color is unique but not red or amber/yellow. (Source: Advisory Circular AC 25 - 11).

Aircraft Address - A unique combination of twenty-four bits available for assignment to an aircraft for the purpose of air-ground communications, navigation and surveillance. [A297] In the context of UAT, the term “address” is used to indicate the information field in an ADS-B message that identifies the ADS-B unit that issued the message. The address provides a continent means by which ADS-B receiving units—or end applications—can sort messages received from multiple issuing units.

Aircraft/Vehicle (A/V) - Either 1) a machine or service capable of atmospheric flight, or 2) a vehicle on the airport surface movement area. In addition to A/Vs, ADS-B equipage

may be extended to temporarily uncharted obstacles (i.e., obstacles not identified by a current NOTAM).

Applications - The ultimate use of an information system, as distinguished from the system itself. [A570] For the case of ADS-B, applications are defined in terms of specific operational scenarios.

Barometric Altitude - Geopotential altitude in the earth's atmosphere above mean standard sea level pressure datum surface, measured by a pressure (barometric) altimeter.

Barometric Altitude Error - For a given true barometric pressure, P_o , the error is the difference between the transmitted pressure altitude and the altitude determined using a standard temperature and pressure model with P_o .

Call Sign - The term “aircraft call sign” means the radiotelephony call sign assigned to an aircraft for voice communications purposes. (This term is sometimes used interchangeably with “flight identification” or “flight ID”). For general aviation aircraft, the aircraft call sign is normally its national registration number; for airline and commuter aircraft, it is usually comprised of the company name and flight number (and therefore not linked to a particular airframe); and for the military, it usually consists of numbers and code words with special significance for the operation being conducted.

Cockpit Display of Traffic Information (CDTI) - A generic avionics device on the flight deck that is capable of displaying the position information of nearby aircraft. It may also include ground reference points and navigation information to increase the AIRSAW. [C245] In the specific context of UAT, a function which provides the pilot/flight-crew with surveillance information about other aircraft, including their position. The information may be presented on a dedicated multi-function display (MFD), or be processed for presentation on existing cockpit flight displays. Traffic information for the CDTI function may be obtained from one or multiple sources (including ADS-B, TCAS, and TIS) and it may be used for a variety of purposes. Requirements for CDTI information will be based on intended use of the data (i.e., application).

Collision Avoidance - An unplanned maneuver to avoid a collision.

Conflict - Predicted covering of aircraft in space and time which constitutes a violation of a given separation minima. [C365] In the specific context of UAT, any situation involving two or more aircraft, or an aircraft and an airspace, or an aircraft and ground terrain, in which the applicable separation minima may be violated.

Conflict Management - Process of detecting and resolving conflicts.

Coordinated Time Scales – A time scale synchronised within stated limits to a reference time scale. Co-ordinated Universal Time (UTC) is the time scale maintained by Bureau International des Poids et Mesures (BIPM), and the International Earth Rotation Service (IERS), which forms the basis of a co-ordinated dissemination of standard frequencies

and time signal. It corresponds exactly in the rate with the International Atomic Time (TAI), but differs from it by an integer number of seconds.

Data Channel – In the context of UAT Ground Stations, a “Data Channel” is a time slot sized resource assignable to a Ground Station for the transmission of Ground Uplink Messages. The actual time slot used shifts on a continual basis per a defined time slot rotation scheme.

Data Channel Block (DCB) – The “Data Channel Block” of a UAT Ground Station is the fixed set of one or more Data Channels assigned to that UAT Ground Station.

Eye Diagram – The eye diagram of the transmitted UAT wave form can be constructed from a graph of frequency deviation versus time by overlaying multiple versions of the graph shifted by integral numbers of symbol (bit) periods. An example can be seen in Figure A-1. The timing of the points where the lines converge defines the “optimum sampling point.” Figure A-2 shows an eye pattern that has been partially closed.

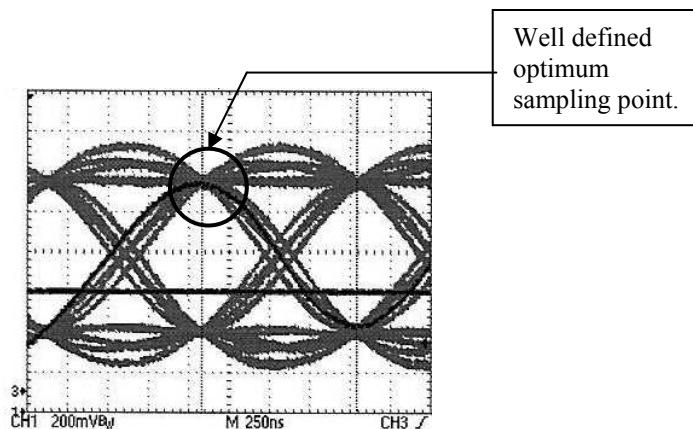

Figure A-1: Ideal eye diagram

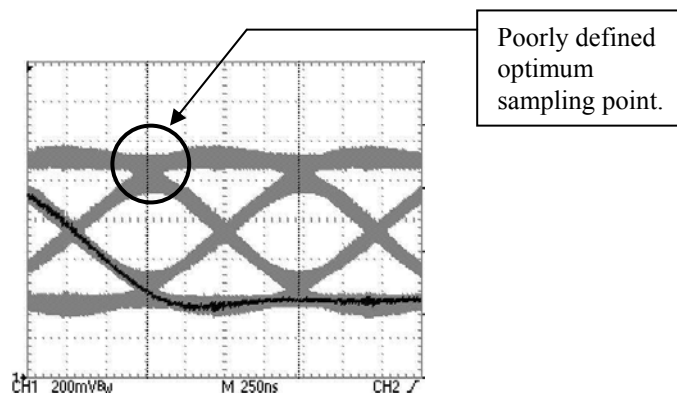

Figure A-2: Distorted eye diagram

Field - The elements of the UAT ADS-B Message Data Block. Most of these elements are enumerated in the ADS-B Minimum Aviation System Performance Standards (MASPS) document, RTCA Document DO-242A (e.g., Latitude, Longitude, Velocity, etc.).

Global Navigation Satellite System (GNSS) - A worldwide position and time determination system that includes one or more satellite constellations, aircraft receivers and system integrity monitoring, augmented as necessary to support the required navigation performance for the intended operation. [G56]

Global Positioning System (GPS) - The satellite navigation system operated by the United States. [G60]

Ground Uplink Message - A message containing 432 bytes of data transmitted only by UAT Ground Stations and only within the ground segment of the UAT frame.

Horizontal Figure of Merit (HFOM) - A 95% bound on the horizontal position error.

JTIDS - Joint Tactical Information Distribution System is a military command, control, and communications system operated by several States which is implemented on a frequency hopping basis on 51 frequencies between 969 MHz and 1206 MHz. This system is also called "Link 16." A further implementation of this system's waveform is known as "MIDS" (Multifunction Information Distribution System). This system is operated on a non-interfering basis with aeronautical radio navigation systems.

Latency - The latency of an ADS-B transmission is the time period from the time of applicability of the aircraft/vehicle position ADS-B report until the transmission of that ADS-B report is completed.

Message - The actual RF transmission on the UAT frequency. There are fundamentally two message types: ADS-B Messages and Ground Uplink Messages. (See ADS-B Message.)

Message Data Block (MDB) - The portion of the UAT ADS-B Message that carries data (user information) that will be consumed by application systems outside the UAT system.

Message Data Block Selection Cycle – A 16 second time interval during which each of up to 4 ADS-B Message types is transmitted at least 4 times (in order to optimize the effect of antenna diversity).

Message Overhead – The portion of the message which supports the physical layer transfer of the data.

Message Reception and Decoding – The primary function of the Message Reception and Decoding function is to deliver all Successful Message Receptions to the Report Assembly Function.

Message Start Opportunity – Discrete times separated by 250 μ sec which define the moments when messages can be transmitted. The MSO selected for each transmission changes each second as a result of a pseudorandom process.

Message Transmission Cycle – A period of 16 seconds in which each MTO appears four times in a pattern that ensures a proper mix of message types are distributed to both Top and Bottom antennas when diversity transmission is used.

Mode A/C/S – As referred to in this document, Mode A/C transponders are those that conform to the characteristics prescribed in ICAO Annex 10, Volume IV, paragraph 3.1.1. Mode S transponders are those that conform to the characteristics prescribed in ICAO Annex 10, Volume IV, paragraph 3.1.2. The functional capabilities of Mode A/C transponders are an integral part of those of Mode S transponders.

Optimum Sampling Point – The point during the bit period at which the opening of the eye diagram (i.e., the minimum separation between positive and negative frequency offsets at very high signal-to-noise ratios) is maximized.

Power Measurement Point (PMP) - A cable connects the antenna to the UAT equipment. The PMP is the end of that cable that attaches to the antenna. All power measurements are considered as being made at the PMP unless otherwise specified. The cable connecting the UAT equipment to the antenna is assumed to have 3 dB of loss.

Product Coverage – The geographical area covered by the information contained in a UAT Ground Uplink Message that conveys FIS-B information. This geographical area may be larger or smaller than the service volume of the Ground Station. It also includes the geographical area covered by the information contained in UAT ADS-B Messages broadcast by a single Ground Station that convey TIS-B information.

Report - The encapsulated Message Data Block elements of received UAT ADS-B Messages that is forwarded to on-board application processors. (See ADS-B Report.)

Report Assembly Function - The Report Assembly Function receives all Successful Message Receptions from the Message Reception and Decoding function and structures Reports for delivery to the Report Output Storage Buffer.

Required Navigation Performance (RNP) - A statement of the navigation performance necessary for operation within a defined airspace. Note. – Navigation performance and requirements are defined for a particular RNP type and/or application. [R192]

Resolution - A number of units or digits to which a measured or calculated value is expressed and used. [R220] In the specific context of UAT, the smallest increment reported in an ADS-B message field. The representation of the least significant bit (LSB) in an ADS-B message field.

Seamless - A “chock-to-chock” continuous and common view of the surveillance situation from the perspective of all users.

Service Volume – A part of the facility coverage where the facility provides a particular service in accordance with relevant SARPs, and within which the facility is afforded frequency protection.

State Vector - An aircraft or vehicle’s current kinematic state.

Successful Message Reception – Detection of synchronization pattern and successful FEC decoding for either ADS-B or uplink (i.e., FIS-B) messages.

Target - Aircraft or vehicle from which an ADS-B Message can be received, or which can be the subject of a TIS-B Message uplinked by a UAT Ground Station.

Target State (TS) Report – The Target State (TS) Report provides information on the intended horizontal and vertical positions toward which the aircraft is maneuvering for the active flight segment.

Track Angle - Instantaneous angle measured from either true or magnetic north to the aircraft's track.

Traffic Information Service – Broadcast (TIS-B) - A service that broadcasts traffic information derived from one or more ground surveillance sources to suitably equipped aircraft or surface vehicles.

Transition Level (TRL) - The lowest flight level available for use above the transition altitude. [T194]

Transponder Diplexer Channel – RF path of the (optional) Diplexer which connects an SSR Transponder to the antenna. This RF path provides a passband which includes the 1030 MHz SSR interrogation frequency and the 1090 MHz SSR reply frequency.

Trigger – Detection of ADS-B or Ground Uplink synchronization sequence.

UAT Diplexer Channel – RF path of the (optional) Diplexer which connects the UAT equipment to the antenna. This RF path provides a passband centered at the UAT frequency of 978 MHz.

UAT Frame – In the UAT system, the *frame* is the most fundamental time unit. Frames are one second long, and begin at the start of each UTC (or GPS) second. Each frame is divided into two segments: one segment in which Ground Uplink messages occur, and another segment in which ADS-B messages occur.

UTC (Coordinated Universal Time) – See coordinated time scales. [C469]

UTC 1 second epoch signal – The reference timing used to establish message transmit and reception times with precision, as well as the time of applicability of Position and Velocity when the UAT transmitter is “UTC Coupled” to a GPS/GNSS navigation source.

Vertical Figure of Merit (VFOM) - A 95% bound on the vertical position error.

World Geodetic System (WGS) - A consistent set of parameters describing the size and shape of the earth, the positions of a network of points with respect to the center of mass of the earth, transformations from major geodetic datum's, and the potential of the earth (usually in terms of harmonic coefficients).

World Geodetic System 1984 - A set of quantities, developed by the U.S. Department of Defense for determining geometric and physical geodetic relationships on a global scale, based on a geocentric origin and a reference ellipsoid with semi-major axis 6378137 and flattening 1/298.257223563.

This page intentionally left blank.

Appendix B

UAT System Performance Simulation Results

This page intentionally left blank.

B UAT System Performance Simulation Results

B.1 Introduction

B.1.1 Organization

This introductory section discusses the background and assumptions for the Multi-Aircraft UAT Simulation (MAUS), which has been used as a tool for evaluating the performance of UAT as an ADS-B data link under a number of different possible system parameters and configurations.

Section B.2 describes in detail the antenna gain model, which is used by MAUS in calculating the signal levels received from the transmitting aircraft in the simulation. This antenna gain model is identical to that used in simulations employed in the past to evaluate all three ADS-B link candidates (see, for example, Comparative Analysis of Potential ADS-B Links, AMCP/8).

The UAT receiver performance model used by MAUS is described in Section B.3. The model is based on measured data, and both the data and model characteristics are described in this section.

The results shown in Section B.4 are compared to RTCA/DO-242A requirements as specified in Table 3-4(a) "SV and MS Accuracy, Update Interval, and Acquisition Range Requirements" and Table 3-4(c) "Summary of TS and TC Report Acquisition Range and Uplink Interval Requirements." Section B.4 presents results for the analysis of UAT performance. Section B.4.1 describes the Los Angeles 2020 scenario and the UAT system performance in this environment. Section B.4.2 presents the Core Europe scenario, and describes the performance of UAT in this environment. Section B.4.3 describes and presents results for the Low Density scenario. Acquisition performance is presented in Section B.4.4, and aircraft-aircraft performance on the surface is discussed in Section B.4.5. Section B.4.6 presents the results for an A0 receiver on the surface receiving aircraft on approach. Section B.4.7 describes results of a study on the use of a geographical distribution of UAT ground stations for uplinking TIS-B information in the LA 2020 environment.

Finally, validation of the MAUS results is presented in Section 0. This section describes a comparison of MAUS predictions with measured data from specially devised test equipment. This equipment was designed to emulate a high-density UAT self-interference environment, and the MAUS was run for identical conditions.

B.1.2 Background

Analytical models and detailed simulations of data links operating in future scenarios are required to assess expected capabilities in stressed circumstances. Accurately modeling future capabilities for potential system designs in a fair way, however, is challenging. Since validation of simulation results in future environments is unrealistic, other means of verification such as the following are required. System characteristics represented in these simulations should agree with actual measurements on components of the proposed design, e.g., bench measurements on prototype equipment and calibrated flight test data should be used, when possible, for the receiver/decoder capabilities and as comparison with modeled link budgets. Similarly, suitable interference models help to support estimates of how these conditions may change in future scenarios. Credibility of any simulation results for future scenarios also requires that they be able to model current

conditions and provide results that appropriately agree with measurements made under these conditions. Existing tools have been used as cross-checks where possible for the final detailed simulations and models.

B.1.3 General Assumptions

In an effort to capture as many real-world effects important to the assessment of the performance of UAT as possible, an attempt was made to include, to the extent possible, representations of the effects of:

- Propagation and cable losses
- Antenna gains
- Propagation delays
- Co-channel interference (specifically, DME/TACAN and JTIDS (Link 16))
- Co-site interference (in and out of band)
- Multiple self-interference sources
- Alternating transmissions between top and bottom antennas (where applicable)
- Performance as a function of receiver configuration (e.g., diversity, switched, bottom only)
- Transmit power variability and configuration
- Receiver re-triggering
- Receiver performance based on bench testing
- Message transmission sequence and information content by aircraft equipage
- Ground receiver assumptions

Section B.4.7.1 will contain additional assumptions that were required to analyze the TIS-B uplink performance of UAT.

B.1.4 UAT Detailed Simulation Description and Limitations

The UAT detailed simulation software is written in C and allows for horizontal, constant-velocity motion of the aircraft in the scenario, if the user so chooses. The simulation reads in the inputs specifying the particular case to be run, generates all of the ADS-B transmissions and interference, calculates signal levels and times of arrival for these transmissions, and determines the corresponding message error rates for each ADS-B transmission by all aircraft within line of sight of the victim receiver. MAUS is often run in a mode that regards all of the ADS-B transmissions by the air traffic scenario as interference, and inserts a number of probe aircraft as desired transmitters to provide message error rate data. This permits the augmentation of the statistical sample used. This information is then written to an output file, one entry line for each ADS-B transmission, which is then analyzed by post-simulation software. Each of the effects listed in Section B.1.2 will now be discussed in turn.

- Propagation and cable losses. The UAT simulation calculates the free-space propagation loss for each transmission, using the range between transmitter and

receiver at the time of transmission. There is also a nominal receiver cable loss of 3 dB incorporated in the calculation. An optional transmit cable loss is also included in the simulation, but since the transmit powers have been defined at the antenna, the transmit cable loss has been set to zero.

- Antenna gains. The antenna gain model included in the UAT simulation is described in Section B.2.
- Propagation delays. Calculation of the propagation delay incurred by the signal in traversing the free space between transmitter and receiver has been included in the UAT simulation
- Co-channel interference. In certain geographic areas, UAT may have to co-exist with transmissions from DME/TACAN and Link 16 sources. Link 16 scenarios have been provided in cooperation with the USDOD and have been applied to all of the performance analysis shown in this document. Various DME/TACAN scenarios provided by Eurocontrol have been applied to Core Europe analysis. In all cases, every attempt was made to provide conservative estimates of the co-channel interference environment. (see Appendix C for more detailed explanation of the interference environment)
- Co-site interference. Co-site transmissions of UAT messages, DME interrogations, Mode S interrogations and replies, whisper-shout interrogations, and ATCRBS replies are all modeled as interference in the UAT simulation. All of these are treated as interference which completely blocks UAT reception; therefore, it is assumed that no UAT reception may occur during any of these co-site transmissions (including a 15 microsecond suppression period added to the end of each co-site transmission). (see Appendix C for more detailed explanation of the interference environment)
- Multiple self-interference sources. Although the UAT transmission protocol specifies that a transmission begin on one of a fixed number of message start opportunities, the propagation delay described above will cause the arrivals of messages at the victim receiver to be quasi-random. There may be a number of messages overlapping one another, and these overlaps will be for variable amounts of time. This interference is accounted for in the multi-aircraft simulation. Multiple UAT interferers are treated in the receiver performance model by combining their interference levels in a way consistent with bench test measurements. The simultaneous presence of UAT interference, co-channel interference, and self-interference is treated in a detailed fashion by the model. Further discussion is presented in Section B.3. Since the UAT system description specifies that the ground uplink transmissions occur in a separate, guarded time segment than the air-to-air transmissions, FIS-B should not interfere with the ADS-B transmissions of the aircraft. Therefore, the simulation does not model this data load for the ADS-B performance assessment.
- Alternating transmissions. The model simulates the alternating transmission sequence specified for A1, A2, and A3 equipage, TTBBTTBB..., where T = top and B = bottom. For A0 equipage, the model simulates transmission from a bottom antenna.
- Receiver diversity. For A2 and A3 equipage, the model simulates receiver diversity by calculating the message error rate at both the top and bottom receive antennas and calculating the joint reception probability. For A1 equipage, the model simulates the single-receiver dual-antenna configuration by switching the receive antenna alternately between top and bottom each successive second. For A0-equipped aircraft, reception is only permitted from a bottom antenna.

- Transmit power variability. The transmit power for an aircraft is chosen from a uniform distribution given by the limits specified for the aircraft equipage. The transmit powers for different equipage levels are defined in Section 2.4.2.1.
- Receiver retriggering. The UAT simulation checks each individual ADS-B Message arriving at the victim receiver for its message error rate. This procedure amounts to allowing for retriggering in the receiver, i.e. the potential for the receiver to switch from receiving a message to a stronger message signal that arrives after the start of the reception of the first message.
- Receiver performance model. The receiver performance model used in the UAT simulation is based on experimental data collected on special UAT receivers that were provided for that purpose. These receivers were modified to be compliant with the requirements specified in this document. Both the 0.8 MHz filter specified for A3 equipage and the 1.2 MHz filter used in A0-A2 equipage were tested. The results of the bench testing and the receiver performance model are described in Section B.3. The sensitivity of the receiver is assumed to be -93 dBm. This represents the signal level at which 10% error rate is achieved in the absence of interfering signals. This parameter was validated in the simulation.
- Message transmission sequence and content. Section 3.1.1 and Table 2-2 of the UAT Technical Manual define the types of messages, their content, and the sequence of messages transmitted for each category of aircraft equipage. See the table in Section B.4.4 for a summary of all the types of information transmitted by each equipage class. The information content transmitted by each aircraft is explicitly modeled by the multi-aircraft simulation.
- Ground receiver assumptions. For Air-Ground studies that follow, several assumptions were changed for the special case of the ground receiver. There was assumed to be no co-site interference, but the same Link 16 Baseline interference used in airborne receptions was included. The receiver sensitivity used was -96 dBm. The antenna gain was slightly different, in that it used an omni-directional TACAN antenna, with elevation gain based on measured data. The ground antenna uses a 1.2 MHz filter only. In certain cases, a 3-sector antenna is used.

B.2 Antenna Model

The antenna gain model contains two components, to accommodate both the elevation pattern variation, as well as non-uniformity in the azimuth pattern. A fixed component is based on the elevation angle between the two aircraft. An additional random component is used to characterize the real-world effects of fuselage blockages in the azimuth pattern. The distributions describing these two components are based on measurement data and are intended to provide sufficient statistical variability to capture a wide variety of antenna installations on aircraft. The two components in dB units are summed to create the total antenna gain pattern for each of a given pair of aircraft.

Figure B-1 shows the elevation gain for a top-mounted antenna. The same gain is used for a bottom-mounted antenna, with the pattern inverted vertically. The antenna has a peak gain of 4.1 dBi at an elevation angle of 26 degrees. For best resolution of display, this figure is limited to a minimum gain of -40 dB.

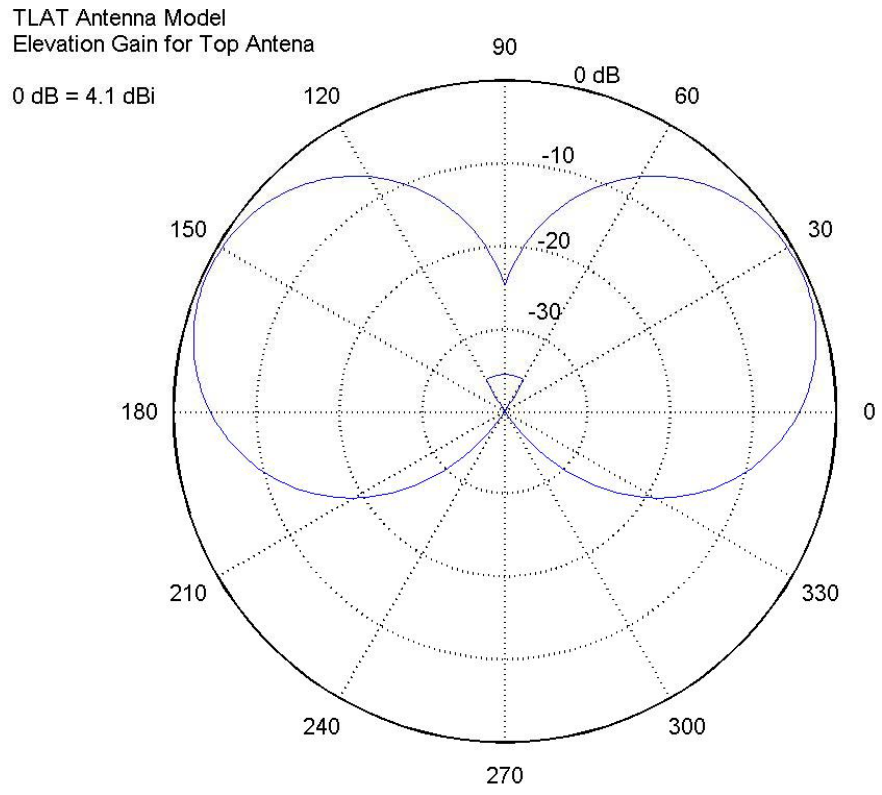

Figure B-1: TLAT Antenna Model Elevation Gain

The variation in gain due to azimuth pattern effects is based on the probability distribution shown in the Figure B-2.

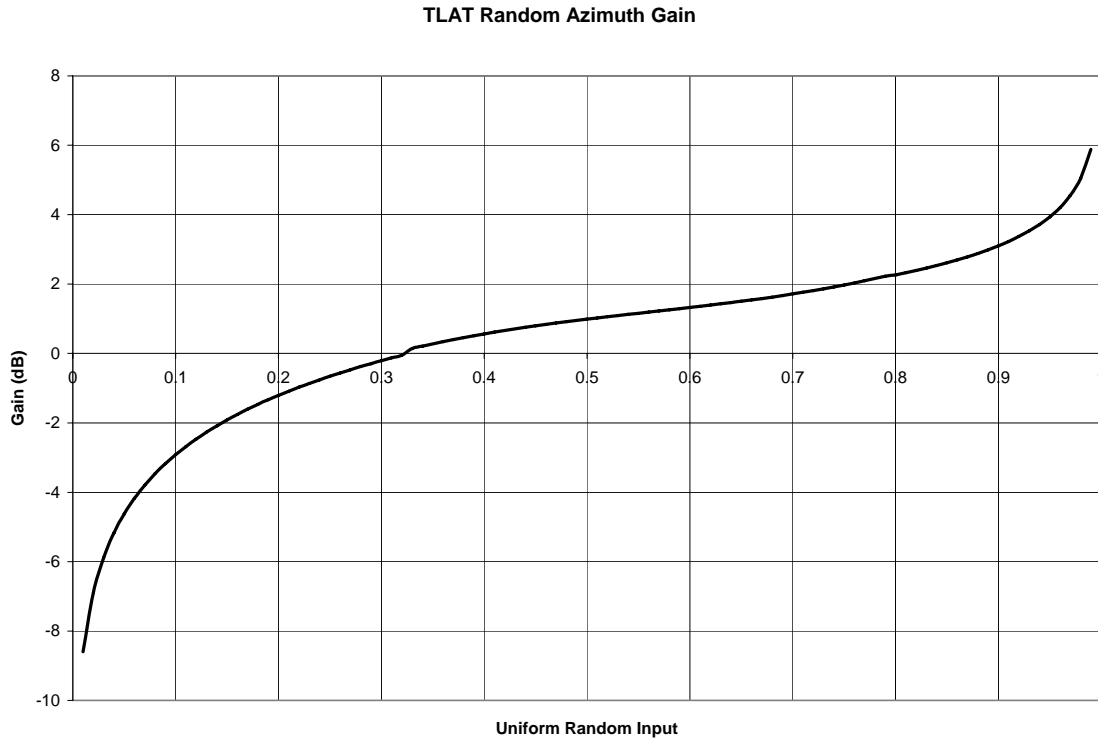

Figure B-2: TLAT Random Azimuth Gain

A uniform random variable on the x-axis is used to select a value that characterizes the azimuth variation in antenna gain. Note that approximately 1/3 of the time, the variation can be a loss of up to 8.6 dB. Approximately 2/3 of the time, the variation is an additional gain of up to 6 dB. Note that the median gain in the azimuthal direction is 1 dB.

The elevation and azimuth angles to other aircraft are constantly changing. To simulate this, the antenna model allows for a new random selection of the azimuth gain variation each time the relative azimuth between a pair of targets is altered by more than 5 degrees. This antenna gain model was used in the performance assessments of each of the three links treated in the Comparative Analysis of Potential ADS-B Links, AMCP/8.

B.3 Receiver Performance Model

B.3.1 Measured Data

Measurements of the Bit Error Rate (BER) receive performance were made on two pre-production UAT transceivers, one with a nominal 1.2 MHz bandwidth and one with a nominal 0.8 MHz bandwidth. Simultaneous measurements were made while the same input signal was applied to both units. The input signal consisted of a Signal of Interest

(SOI), from a nominal 1.5 MHz bandwidth UAT transceiver, summed with an interference signal. The SOI was a Long ADS-B Message.

A BER test fixture was created in order to allow measuring the BER impact of pulsed interference as a function of time relative to the start of the pulse. It included circuitry for gating the test interference signal off during the UAT message synchronization header, and software for determining the position of every bit error in every received Message Data Block or FEC. The test setup is shown in Figure B-3

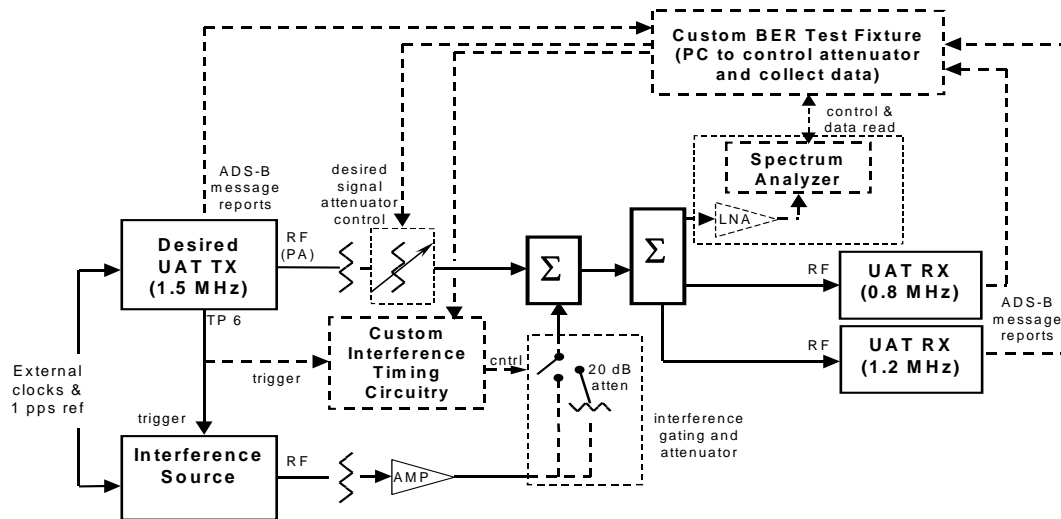

Fixed attenuators and amplifiers are adjusted to provide:

- a desired-signal level at the UAT RX inputs of -20 dBm when signal attenuator is set to 0 dB, and
- a peak interference level at the UAT RX inputs of -20 dBm when interference is gated on and the 20 dB interference attenuator is bypassed.

Figure B-3: Test Setup for measuring BER

The interference signals used for the BER tests were the following:

1. No external interference (internal receiver noise only). SOI level was varied to achieve various Signal-to-Noise Ratios (SNRs). Note that SNR depends on the noise bandwidth used, which will be defined later in this section.
2. White Gaussian interference. SOI level was varied to achieve various SNRs.
3. A single UAT (1.5 MHz bandwidth) interferer. The levels of both SOI and interferer were independently varied to achieve various SNRs and various Interference-to-Noise Ratios (INRs).
4. A simulated combination of multiple UAT (1.5 MHz bandwidth) interferers. An Arbitrary Waveform Generator (AWG) produced these combination signals by playing back a variety of input data files. The input data files were generated from a set of single-UAT files recorded by a digital oscilloscope. These files were adjusted in level, offset in time and summed together to create the multi-UAT scenarios of interest, specifically:
 - Two UATs, both at the same level, and at various INRs.
 - Two UATs at high INR and at various relative levels.

- Three, five and ten UATs, all at the same level and at high INR.
 - (As a check on the fidelity of the simulation, a single UAT at high INR was also simulated and measured and the BER was compared with the corresponding BER measured using an actual UAT at high INR. The discrepancy between the two was found to be less than 0.7 dB.)
5. A DME interferer emitting pulse pairs with 12-usec separation. DME signals at two frequencies were used, at the SOI center frequency and one MHz above. The level of the SOI was varied to achieve a wide range of Signal-to-Interference Ratios (SIRs). The variation of BER with time during and shortly after the DME pulse pair was measured.
 6. A Link 16 interferer, at various frequencies, at the SOI center frequency, three MHz higher, 6 MHz higher and so on up to 21 MHz higher. It was assumed that the corresponding lower frequency response would be similar. The level of the SOI was varied to achieve a wide range of Signal-to-Interference Ratios (SIRs). The variation of BER with time during and shortly after the Link 16 pulse pair was measured.

For all of the above interference conditions, bit errors were measured at every position in the Message Data Block and FEC. Results from multiple messages were averaged together. Enough messages were measured to permit determining BER values down to about 10^{-5} . For the continuous interference conditions (no external interference or Gaussian noise), bit errors from all received Message Data Block and FEC bit were averaged together. For the UAT interferers, bit errors from all Message Data Block and FEC bits during interference transmission were averaged together.

For the pulsed interference conditions (DME and Link 16 signals), bit errors were averaged independently for each time offset after the start of the interference pulse (to a resolution of 0.5 UAT bit periods). This enabled determining BER values as a function of SIR, time and frequency offset. Sample plots of measured BER data for DME and Link 16 interferers are shown in Figure B-4 through Figure B-6.

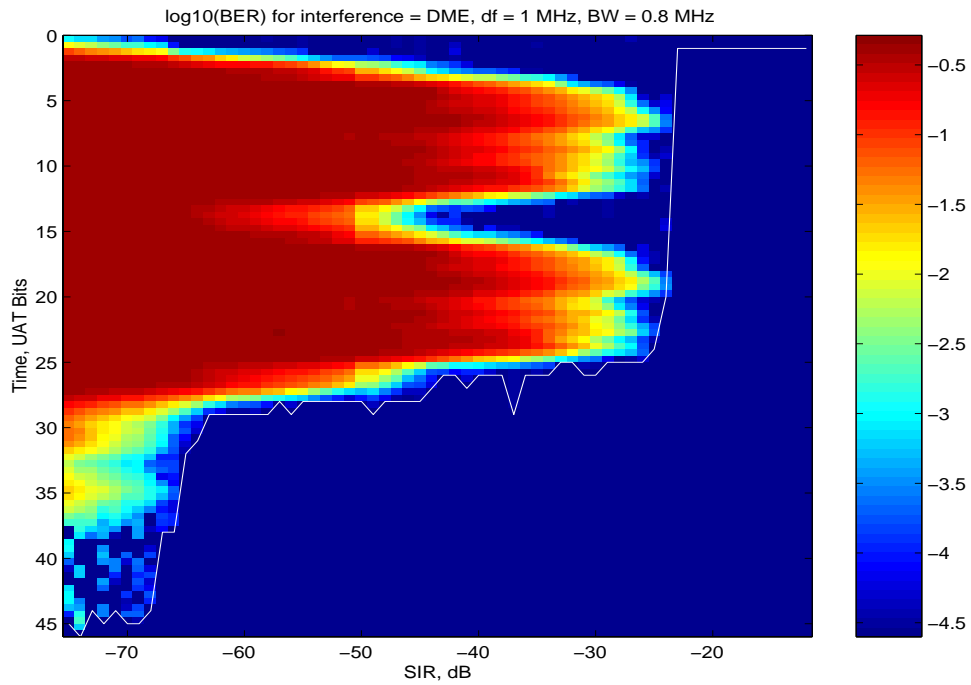

Figure B-4: BER Due to DME interference

(Frequency offset = 1 MHz, Receiver bandwidth = 0.8 MHz. log10 {BER} encoded as color)

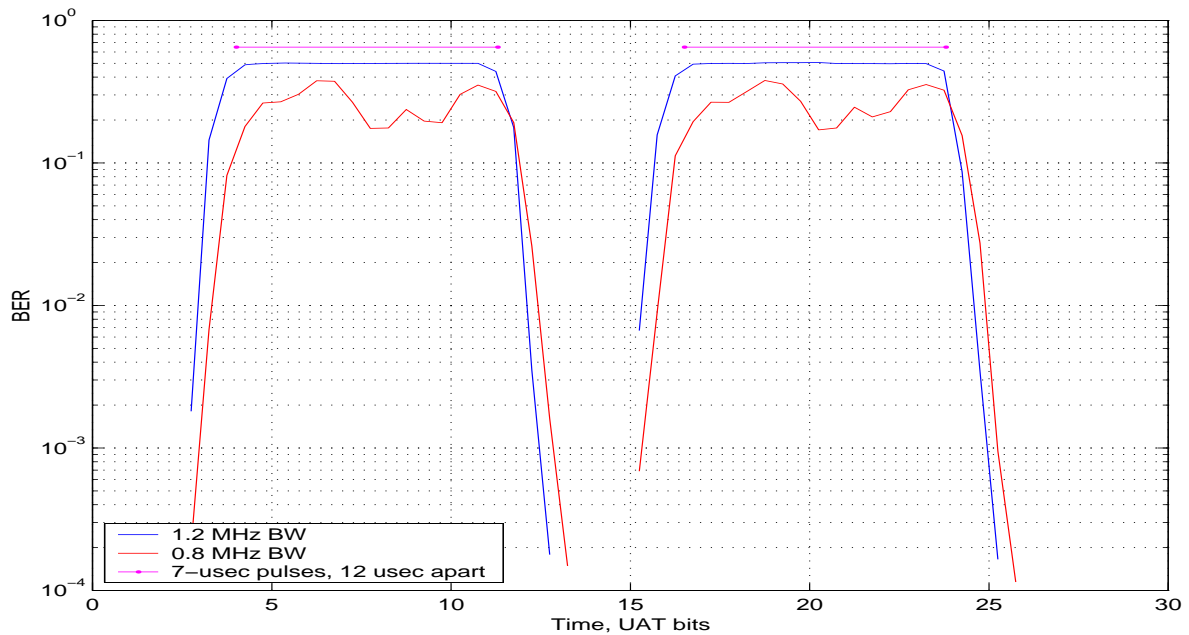

Figure B-5: BER Due to DME Interference

(Frequency offset = 1 MHz, Vertical Slice Through Color Plots Like Figure B-4 at SIR = -40 dB)

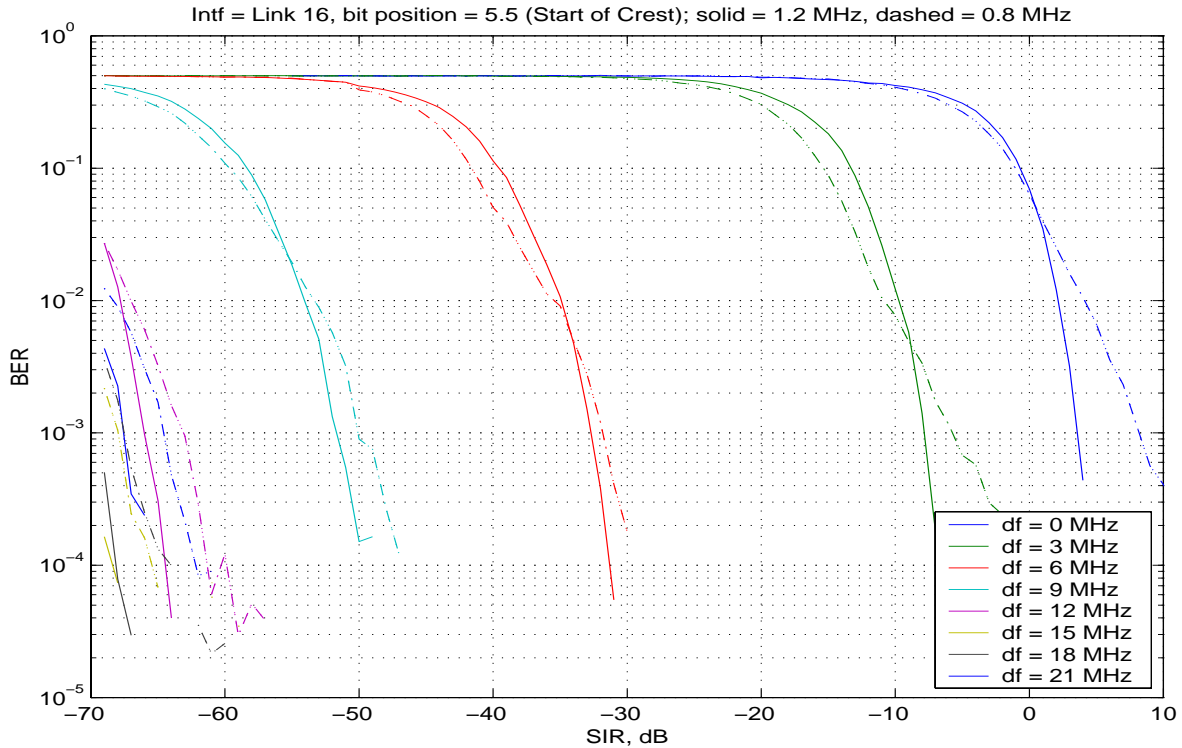

Figure B-6: Link 16 Interference

(Horizontal Slice Through Color Plots Like Figure B-4 at Bit Position 5.5)

B.3.2 Receiver Model

Based on the above BER measurements, a computer program (the “UAT BER Model”) was designed to estimate MOPS-compliant UAT BER performance under arbitrary combinations of UAT, DME and Link 16 interference. The UAT BER Model is incorporated within the Multi-Aircraft UAT Simulation (MAUS), which uses the BER estimates to evaluate the reception success of UAT messages.

B.3.2.1 Receiver Model Accuracy

Figure B-7 through Figure B-10 show the measured and modeled BER Vs. SINR curves for four sample subsets of the measured data. Figure B-9 and Figure B-10 show the BER modeling error for all the Gaussian noise plus UAT interference data so as to indicate the equivalent power error in dB. The BER-to-power curve used for Figure B-11 and Figure B-12 is the curve appropriate for pure Gaussian noise interference. With this measure, it can be seen that most of the data is modeled to + or - 1.5 dB accuracy.

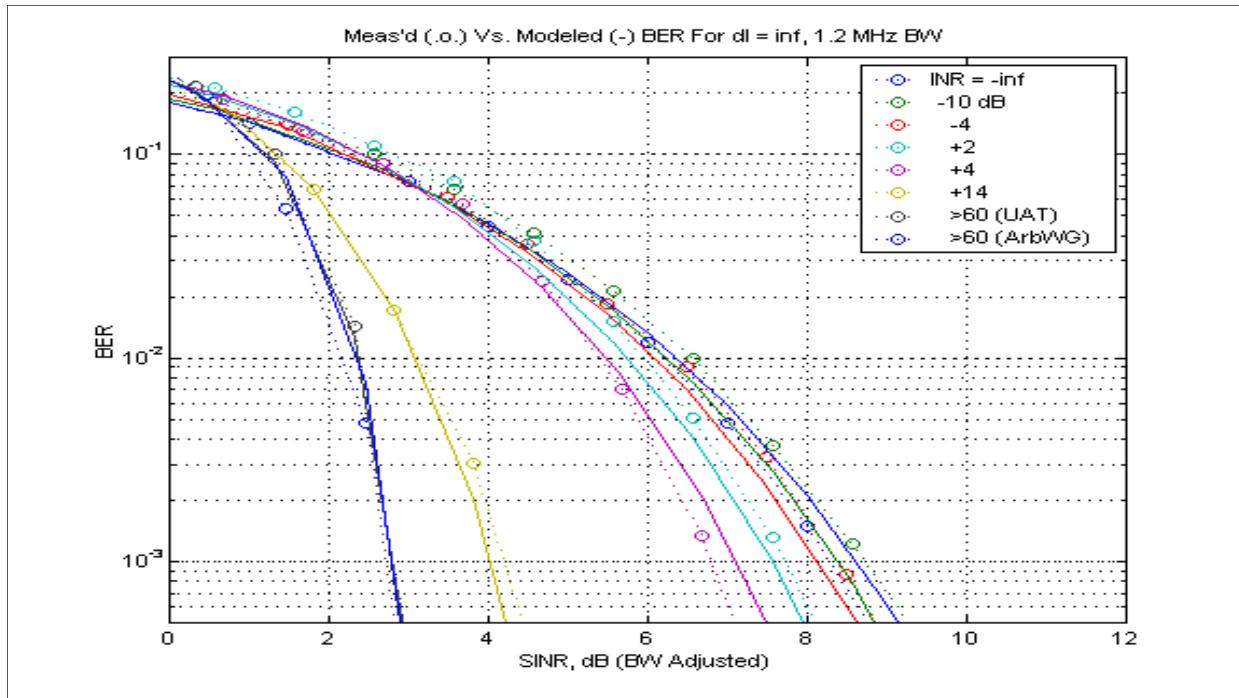

Figure B-7: Gaussian Noise + Single UAT, 1.2 MHz Receiver

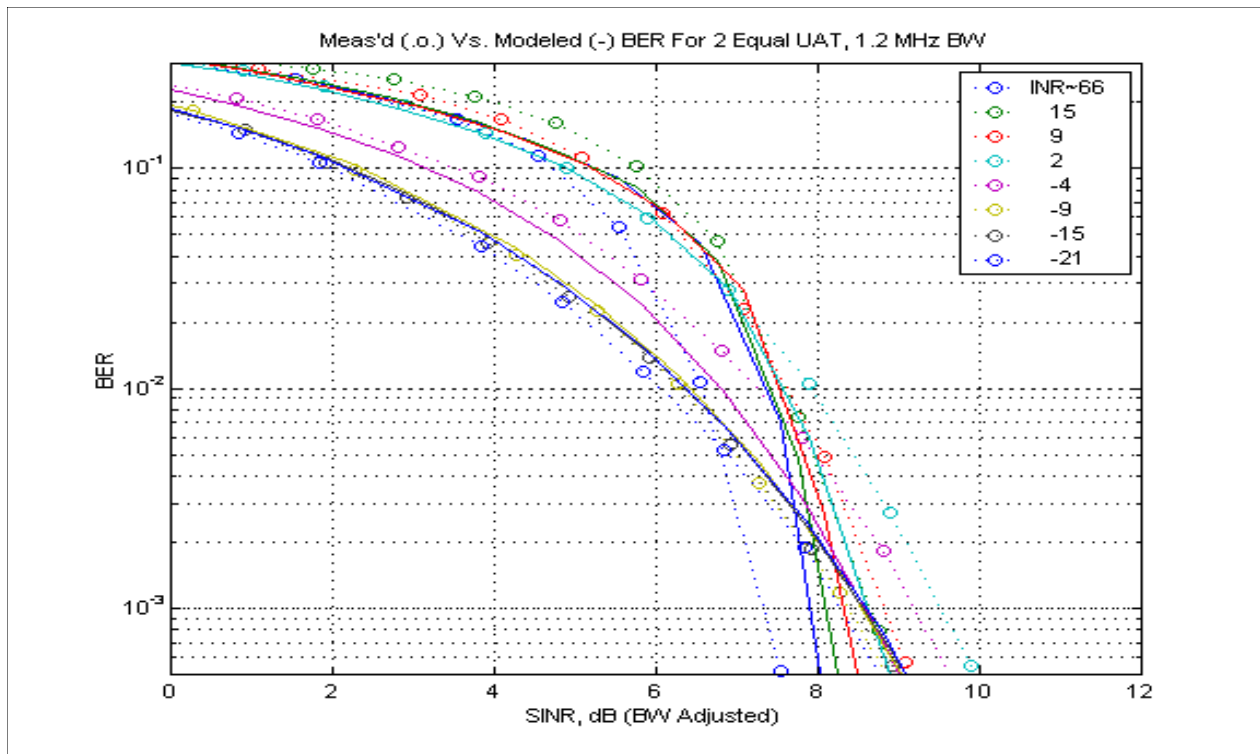

Figure B-8: Gaussian Noise + Two Equal UATs, 1.2 MHz Receiver

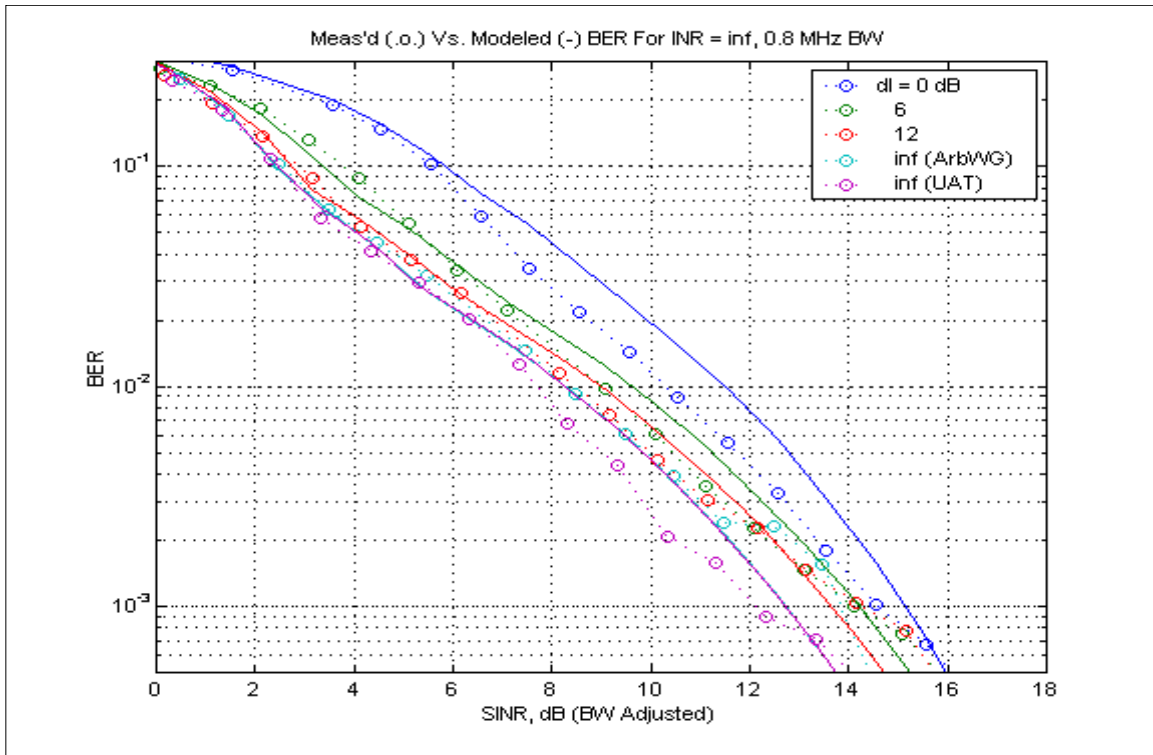

Figure B-9: Two Unequal UATs, INR \gg 0 dB, 0.8 MHz Receiver

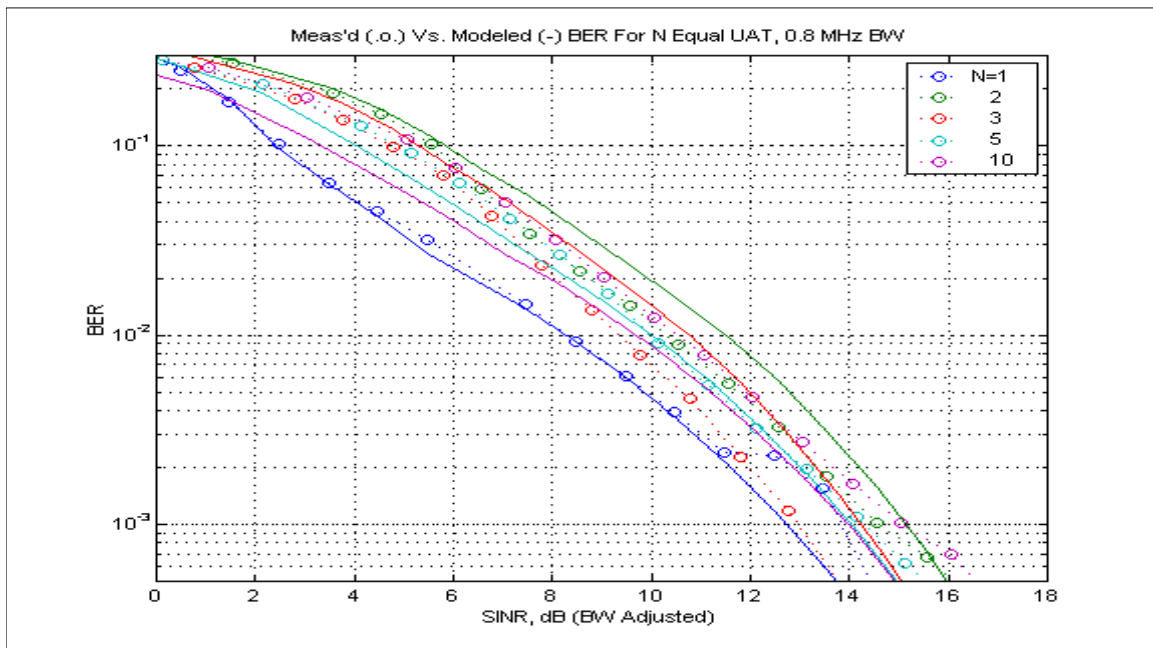

Figure B-10: N Equal UATs, INR \gg 0, 0.8 MHz Receiver

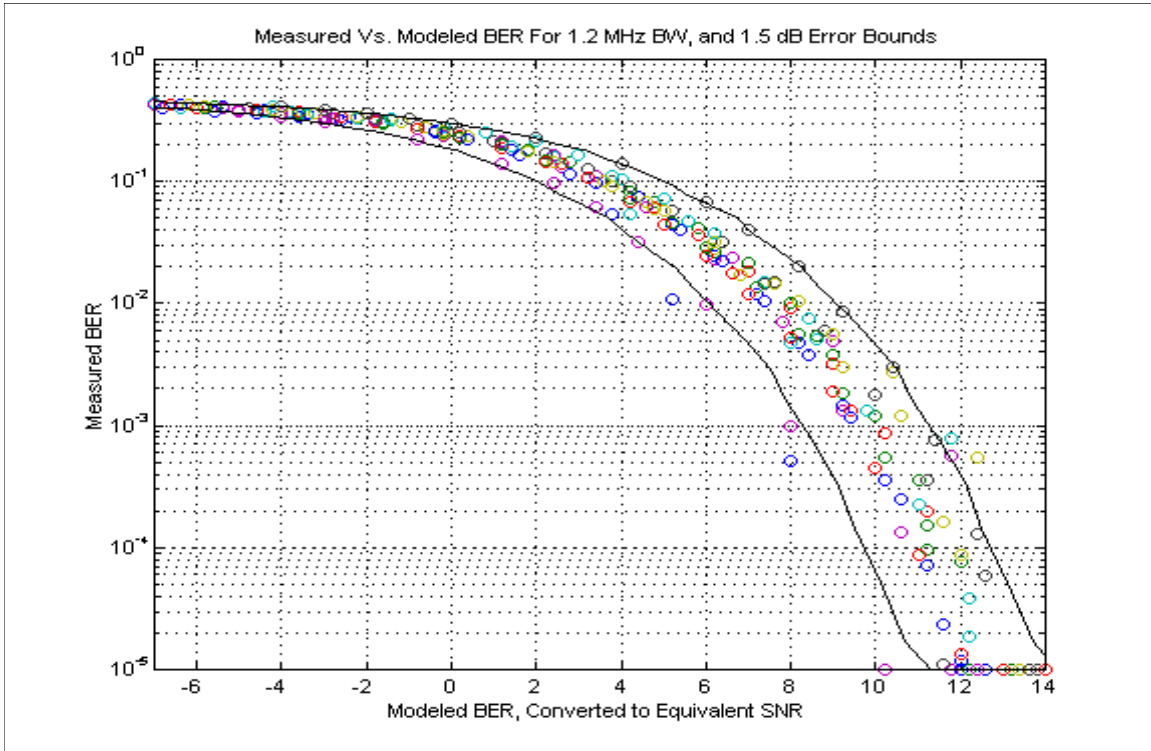

Figure B-11 Model Errors for All Data, 1.2 MHz Receiver

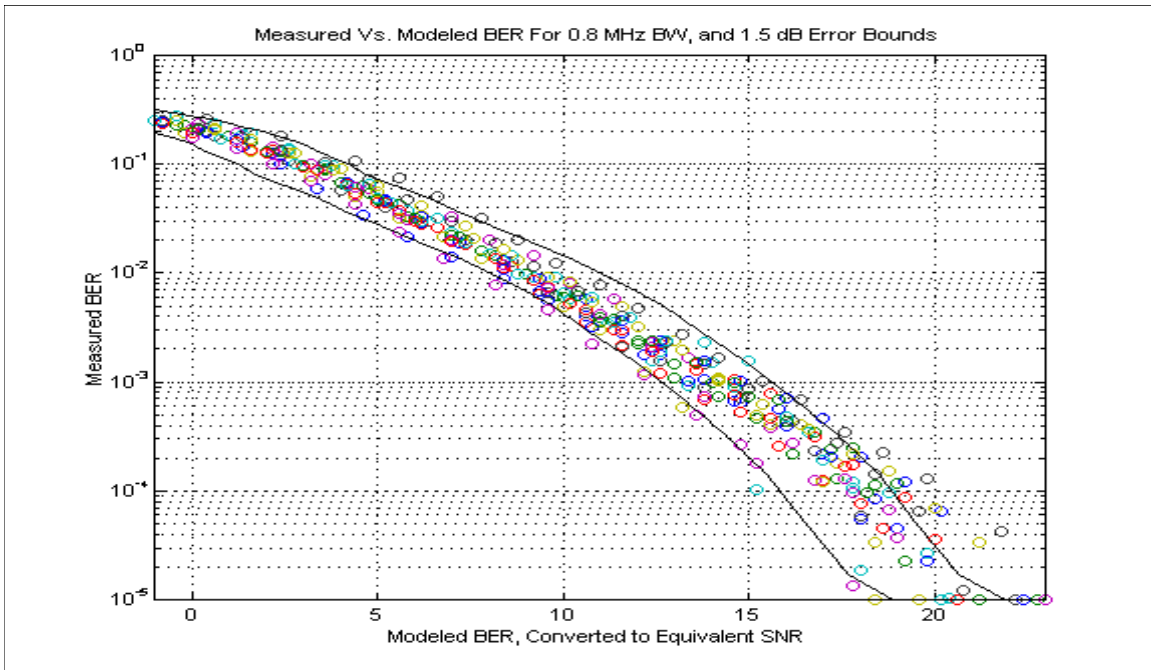

Figure B-12: Model Errors for All Data, 0.8 MHz Receiver

B.4 Multi-Aircraft Simulation (MAUS) Results

B.4.1 Los Angeles Basin 2020 (LA2020)

This scenario is based on the LA Basin 1999 maximum estimate. It is assumed that air traffic in this area would increase by a few percent each year until 2020, when it would be 50 % higher than in 1999. The distribution of aircraft in the scenario is based on approximations of measured altitude and range density distributions.

The following assumptions are made for the airborne and ground aircraft and ground vehicles for the LA Basin 2020 scenario:

- The density of airborne aircraft is taken to be:
 - Constant in range from the center of the area out to 225 nautical miles (5.25 aircraft/NM), (i.e., the inner circle of radius one NM would contain approximately five aircraft, as would the ring from 224 to 225 NM) and
 - Constant in area from 225 NM to 400 NM (.00375 aircraft/NM²).
- There are assumed to be a fixed number of aircraft on the ground (within a circle of radius 5 NM at each airport), divided among LAX, San Diego, Long Beach, and five other small airports, totaling 225 aircraft. Half of the aircraft at each airport were assumed to be moving at 15 knots, while the other half were stationary. In addition, a total of 300 ground vehicles are distributed at these airports as well.
- The altitude distribution of the airborne aircraft is assumed to be exponential, with a mean altitude of 5500 feet. This distribution is assumed to apply over the entire area.
- The airborne aircraft are assumed to have the following average velocities, determined by their altitude. The aircraft velocities for aircraft below 25000 feet are uniformly distributed over a band of average velocity +/- 30 percent.
 - 0-3000 feet altitude 130 knots
 - 3000-10000 ft 200 knots
 - 10000-25000 ft 300 knots
 - 25000-up 450 knots
- The aircraft are all assumed to be moving in random directions.
- ADS-B MASPS equipage class A0 (and A1L as defined in §2.4.2) are restricted to fly below 18000 feet. All other aircraft are assumed to be capable of flying at any altitude. The aircraft in the LA2020 scenario are assumed to be in the following proportions:
 - A3 30%
 - A2 10%
 - A1 40%
 - A0 20%

For the LA2020 scenario, the A1 equipage was assumed to include two subclasses: A1H (high) and A1L (low). These subclasses are defined in Section 2.4.2.

The scenario for the 2020 high density LA Basin case contains a total of 2694 aircraft: 1180 within the core area of 225 NM, 1289 between 225-400 NM, and 225 on the

ground. This represents a scaling of the estimated maximum 1999 LA Basin levels upward by 50 percent. Of these aircraft, 471 lie within 60 NM of the center. (This includes aircraft on the ground.) Around ten percent of the total number of aircraft are above 10000 ft in altitude, and more than half of the aircraft are located in the outer (non-core) area of the scenario.

An attempt was made to at least partially account for the expected lower aircraft density over the ocean. In the third quadrant (between 180 degrees and 270 degrees), for distances greater than 100 NM from the center of the scenario, the density of aircraft is reduced to 25 % of the nominal value used. The other 75 % of aircraft which would have been placed in this area are distributed uniformly among the other three quadrants at the same range from the center. This results in relative densities of 1:5 between the third quadrant and the others.

As outlined in Section 3 of the UAT Requirements and Desirable Features, the ADS-B requirements for ADS-B air-to-air surveillance range and report update interval are used to assess how the candidate links perform in relation to suggested operational enhancements. These requirements specify the minimum range for acquisition of the state vector and the mode-status and TC and TS reports where applicable, as well as the maximum update periods allowed for this information.

The UAT Requirements and Desirable Features contains specific air/ground performance requirements. These air/ground criteria specify ranges and update times. Additionally, air-to-air requirements for long-range deconfliction are also specified.

Results are presented as a series of plots of 95% update times as a function of range for state vector updates and intent updates, where applicable. The 95% time means that at the range specified, 95% of aircraft will achieve a 95% update rate at least equal to that shown. Each point on the plot represents the performance of Aircraft/Vehicles within a 10 NM bin centered on the point. The ADS-B requirements specified in the UAT Requirements and Desirable Features are also included on the plots for reference. Since the transmit power and receiver configuration are defined for each aircraft equipage class, performance is shown separately for each combination of transmit-receive pair types. In addition, performance of different transmit-receive pairs is shown at several different altitudes, where appropriate. The first altitude considered is "high altitude", which is defined to be the aircraft near the center of the scenario with the largest number of other aircraft in view. This is invariably an aircraft in the range of FL 350 – FL 400, and applies to A3, A2, and A1H equipage. The other altitude used is FL150 at the center of the scenario, and applies to all equipage classes.

Results for all of these cases are shown for state vector updates in Figure B-13 through Figure B-21 and conclusions are presented below. The ADS-B requirements for state vector updates are shown as black lines on the plots. As specified in the UAT Requirements and Desirable Features, the maximum required ranges for air-air update rates are: for A0 to 10 NM, A1 to 20 NM, A2 to 40 NM, and A3 to 90 NM (120 NM desired), while the criteria shown on the plots continue to 150 NM for A3. This may not include all potential requirements. Air-ground requirements are defined to 150 NM for all aircraft equipage classes. Performance in compliance with ADS-B requirements is indicated by results that are below the black line.

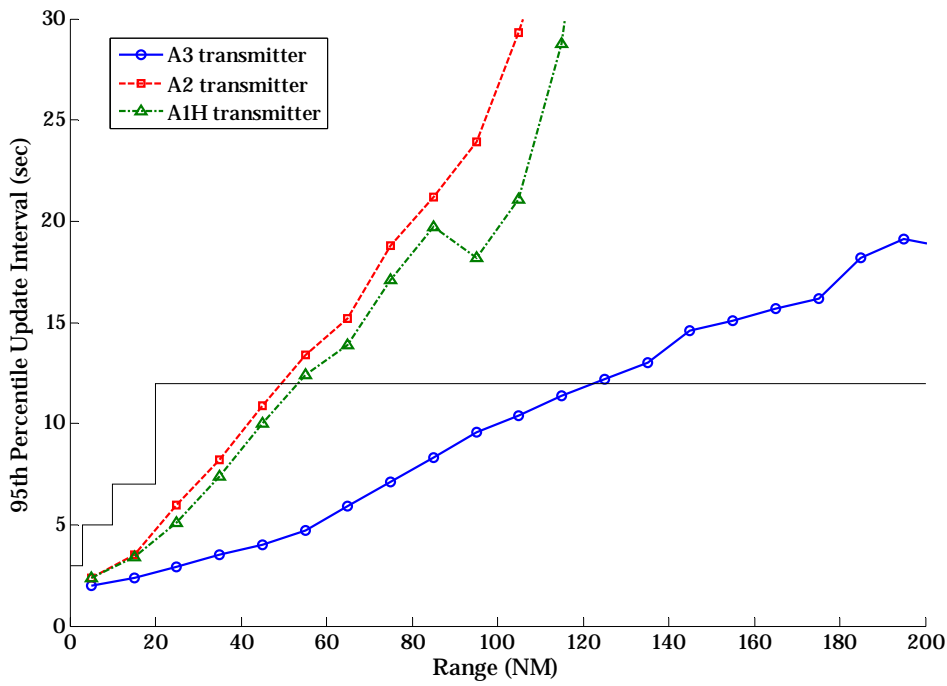

Figure B-13: Air-to-Air Reception by A3 Receiver at High Altitude over LA 2020

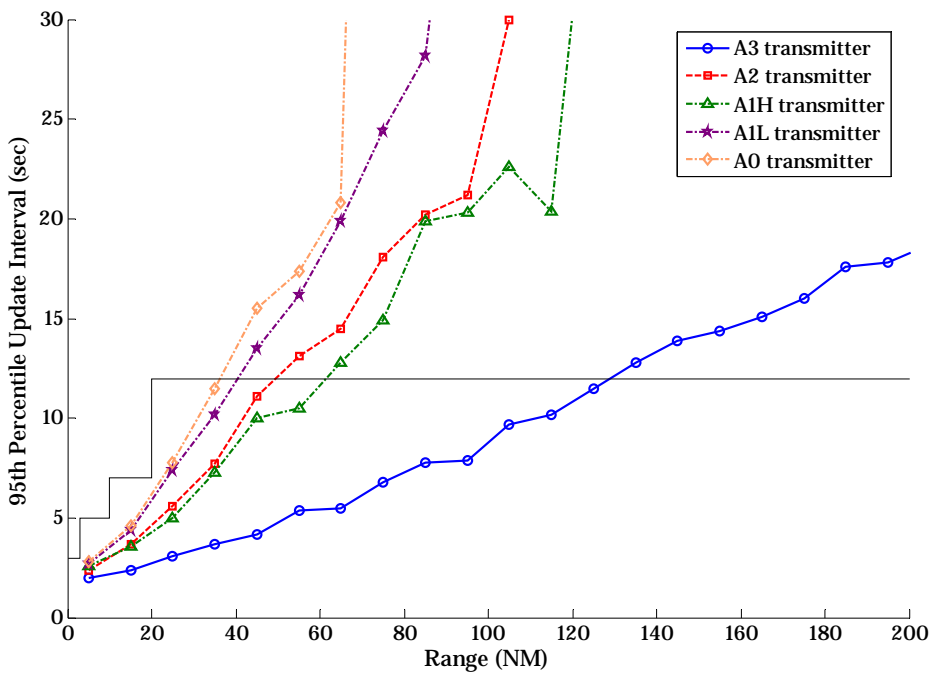

Figure B-14: Air-to-Air Reception by A3 Receiver at FL 150 over LA 2020

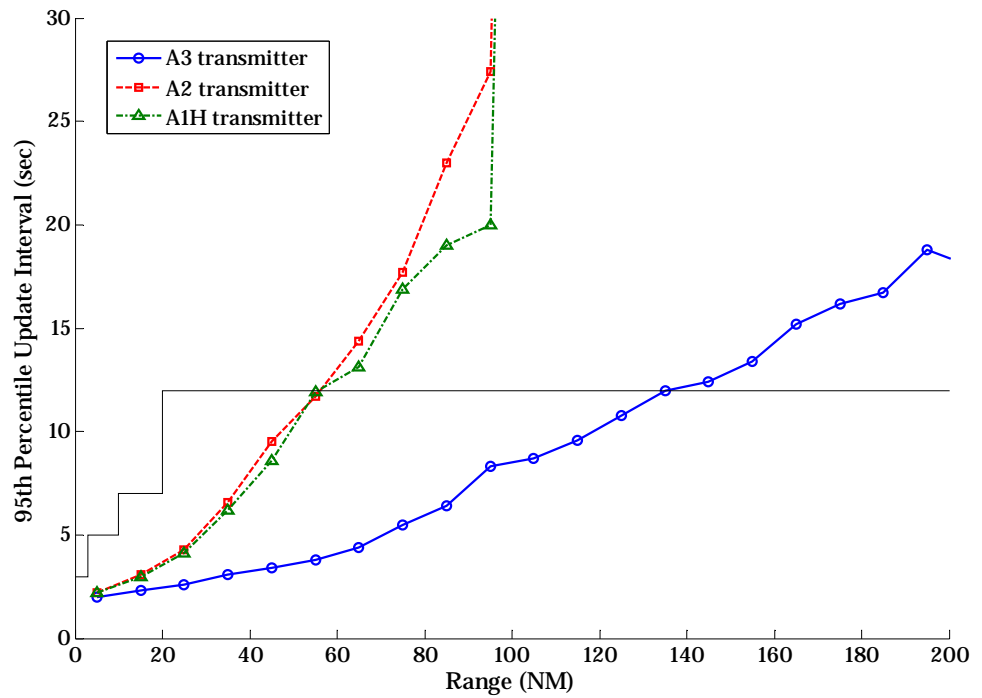

Figure B-15: Air-to-Air Reception by A2 Receiver at High Altitude over LA 2020

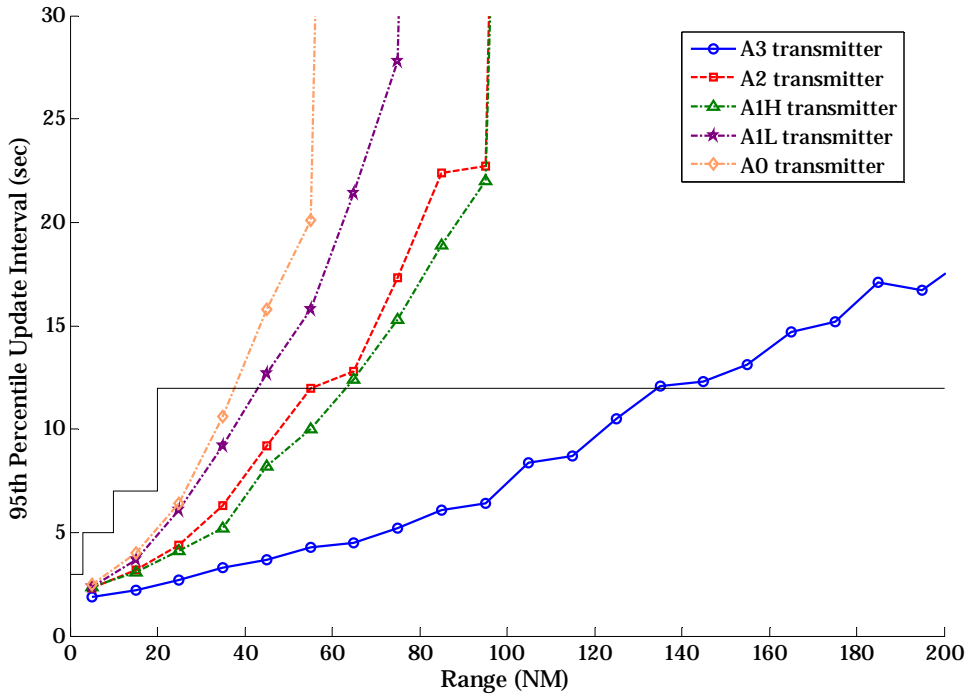

Figure B-16: Air-to-Air Reception by A2 Receiver at FL 150 over LA 2020

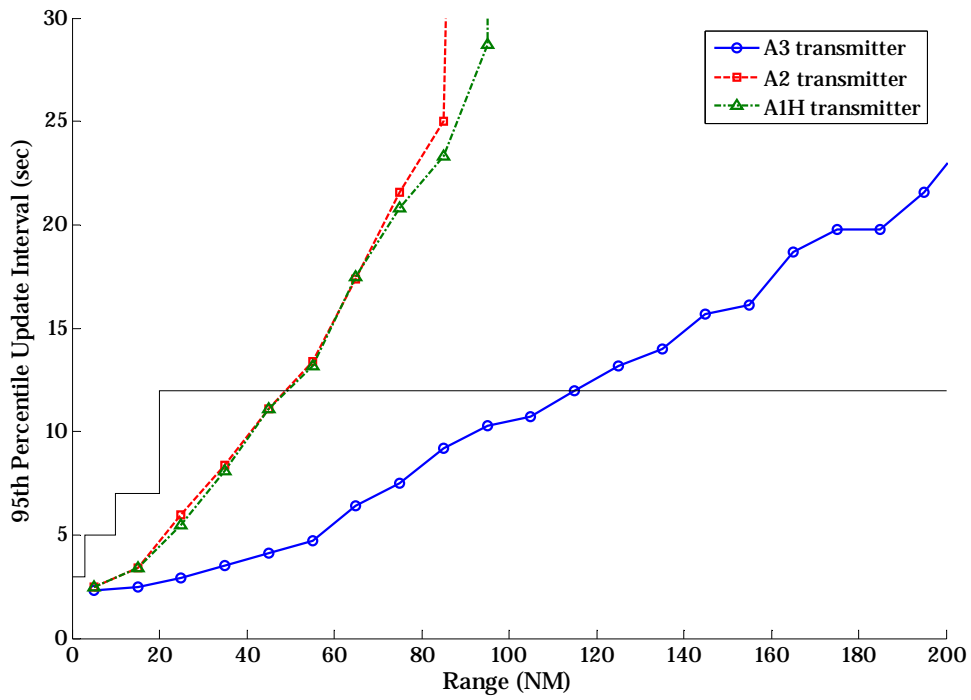

Figure B-17: Air-to-Air Reception by A1 Receiver at High Altitude over LA 2020

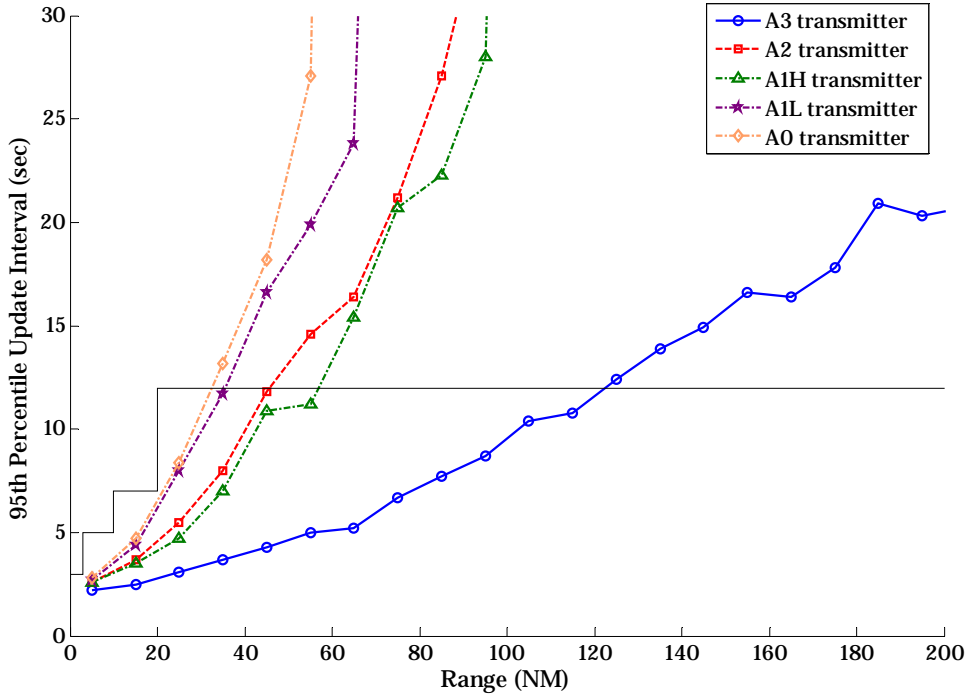

Figure B-18: Air-to-Air Reception by A1 Receiver at FL 150 over LA 2020

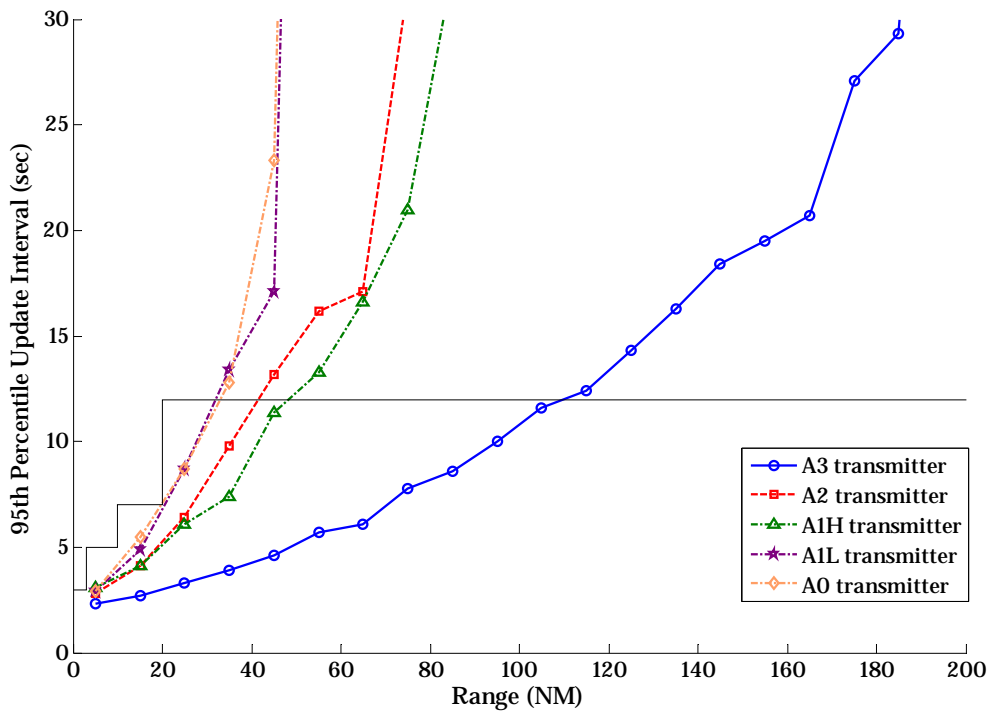

Figure B-19: Air-to-Air Reception by A0 Receiver at FL 150 over LA 2020

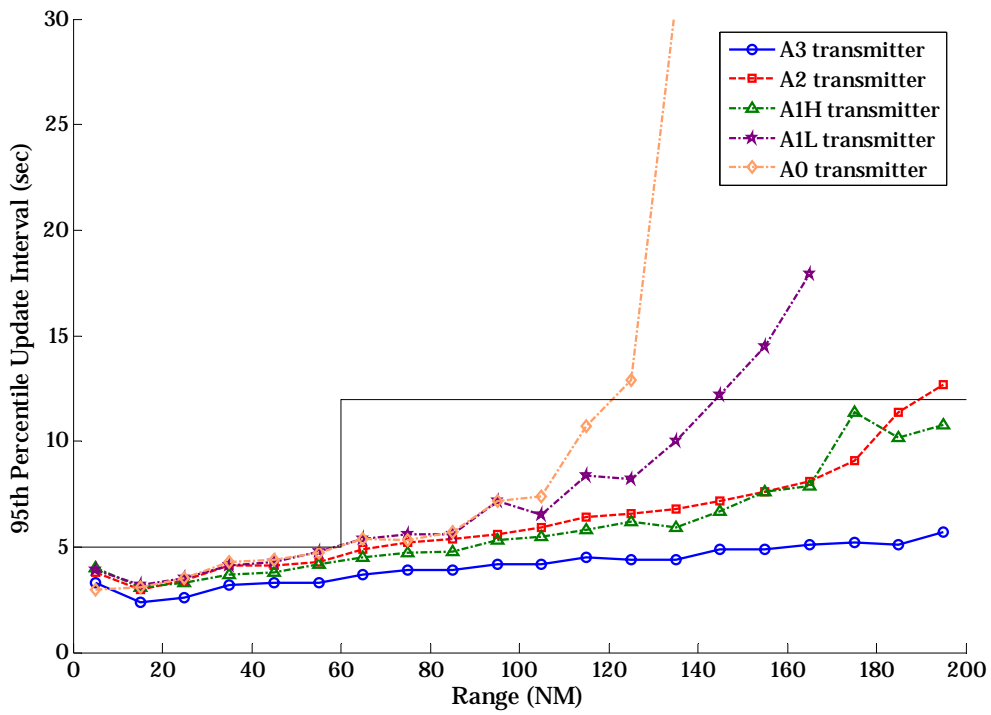

Figure B-20: Air-to-Ground Reception by a Receiver at LAX in LA 2020

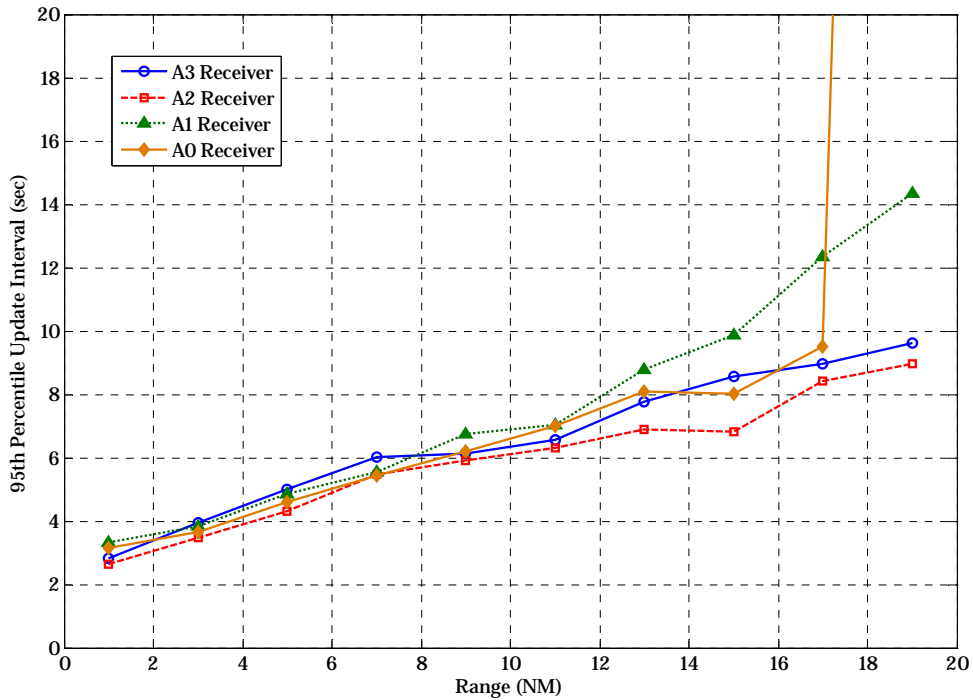

Figure B-21: Reception of Ground Vehicle Transmissions by Aircraft on Approach at 2000 feet into LAX in 2020

Recall that the LA2020 scenario includes 2694 aircraft and 300 ground vehicles transmitting on UAT. In addition, a baseline Link 16 scenario is also included as co-channel interference.

The results for LA2020 UAT air-air system performance shown in Figure B-13 to Figure B-19 are summarized in Table B-1 below. This summary indicates that the UAT System is projected to be fully compliant with the UAT Requirements and Desired Features air-to-air state vector report update requirements at both the required and desired ranges.

Table B-1: Ranges of Compliance for UAT Transmit-Receive Combinations in the LA2020 Scenario

RECEIVER	TRANSMITTER			
	A3	A2	A1	A0
A3 (High Altitude)	120	40+	40+(A1H)	NA
A3 (FL 150)	130	40+	50+(A1H)/30+(A1L)	30+
A2 (High Altitude)	130	50	50(A1H)	NA
A2 (FL 150)	130	50	60(A1H)/40(A1L)	30
A1 (High Altitude)	110	40	40+(A1H)	NA
A1 (Low Altitude)	120	40	40+(A1H)/30(A1L)	30
A0	100+	40	40+(A1H)/30(A1L)	30

The results for the LA2020 scenario shown in Figure B-13 through Figure B-21 may be summarized as follows:

- ADS-B air-air requirements and desired criteria are met for all aircraft equipage transmit-receive pairs in the LA2020 scenario for state vector update rates at all ranges specified by the UAT Requirements and Desirable Features. Performance for receivers located at FL 150 tends to be better in general than the corresponding receivers at high altitude, due primarily to the lower levels of self-interference encountered at lower altitudes.
- The extension to 150 NM for A3 class equipage air-to-air reception is only met for LA2020 at the 95% level out to 120-130 NM, but the 95th percentile update rate at 150 NM is 14-15 seconds, depending on the altitude of the receiving aircraft.
- Air-ground update requirements are met to 150 NM for a standard ground receiver located at LAX in the LA2020 scenario for equipages A3, A2, and A1H. A1L and A0 equipage met requirements out to 140 and 120 NM, respectively. A test case was run for the case of a 980 MHz DME/TACAN co-located with the ground receiver. The results of the test case show that, in the presence of a 5 kw TACAN at 980 MHz located 50 feet away from the ground receiver at LAX in the LA2020 scenario, a three-sector antenna allows the update requirements to be met for all aircraft equipages to 150 NM. Another test case was run for the case of the co-located 980 MHz TACAN with a standard ground receiver, to see what level of power at the UAT antenna could be supported without degradation in performance. The results show that -90 dBm TACAN power at the UAT antenna at 980 MHz does not significantly change the standard ground performance in LA2020: A3, A2, and A1H performance meet the MASPS requirements out to 150 NM, and A1L and A0 meet the requirements out to 120 and 110 NM, respectively. This means that, if the TACAN were located 1000 feet from the ground receive antenna, an additional 30 dB of isolation would be required in order to assure MASPS compliance. This could be achieved by increasing the separation distance, for example.
- System performance results are presented for state vector updates of ground vehicles to an aircraft on approach to LAX in the LA2020 scenario. There is no specific update rate requirement for this situation.

Figure B-22 shows the result for air-to-air ADS-B reception over UAT of Target State Report information in the LA 2020 scenario. This intent information is transmitted by high altitude aircraft (A3, A2, and A1H equipage), and the receiver for this plot is an A3.

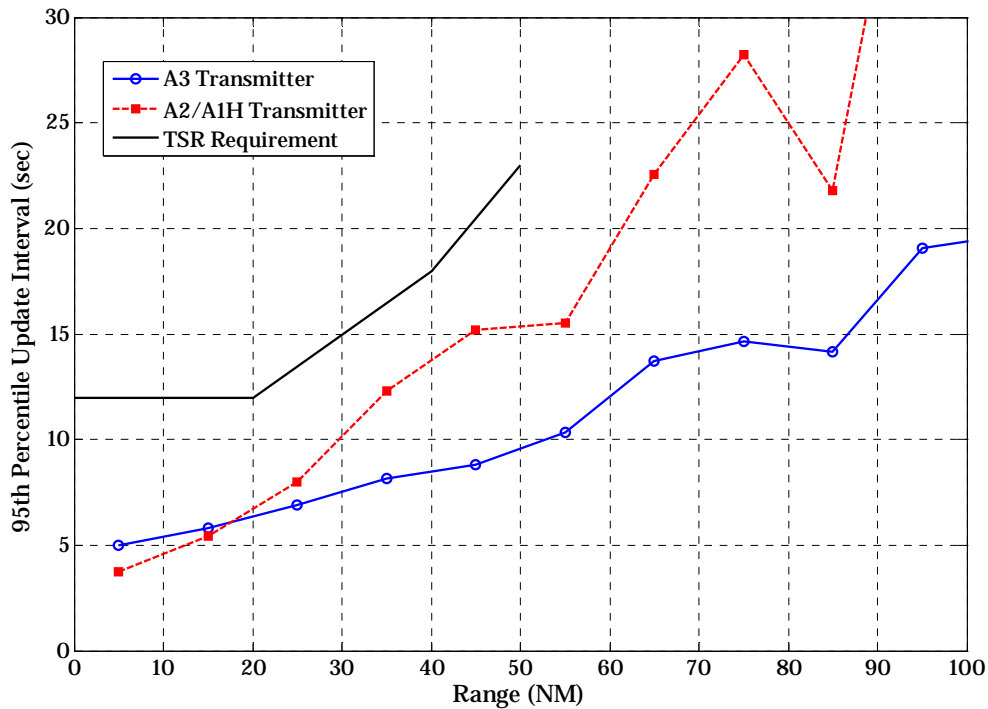

Figure B-22: 95th Percentile Update Interval for Target State Reports as a Function of Range for A3 and A2/A1H Transmitters

The results in Figure B-22 confirm that UAT in a high density environment is expected to meet the air-to-air reception requirement for Target State Reports.

B.4.2 Core Europe 2015

A high density air traffic scenario was developed by Eurocontrol to represent Core Europe in 2015. The operation of UAT in Core Europe 2015 is based on the premise that the existing on-channel DME/TACANs will be moved from 978 MHz to other available frequencies. Therefore, the future scenario assumes that there will be no DME/TACANs on 978 MHz, but that all existing and planned DME/TACANs at 979 MHz will be operational and running at full allowed power levels, no matter how close they are to one another. This condition was chosen in order to provide a conservatively severe estimate of the DME/TACAN interference environment.

Two cases were analyzed: worst-case traffic density (over the center of the scenario at Brussels, selected to provide the highest UAT self-interference levels) and worst-case DME/TACAN environment (location selected to provide the highest interference from DME/TACANs). The worst-case DME/TACAN environment selection required moving a high-power mobile 979 MHz TACAN to a particular location near several other 979 MHz TACANs.

For the Core Europe 2015 scenario, the distributions and assumptions made were taken directly from the Eurocontrol document entitled “High-Density 2015 European Traffic Distributions for Simulation,” dated August 17, 1999. This scenario is well-defined and straightforward to apply. The scenario used in this analysis includes a total of 2091

aircraft (both airborne and ground) and 500 ground vehicles, and is based on the following assumptions:

- There are five major TMAs (Brussels, Amsterdam, London, Paris, and Frankfurt), each of which is characterized by:
 - The inner region (12 NM radius) contains 29 aircraft at lower altitudes,
 - The outer region (50 NM radius) contains 103 aircraft at mid to higher altitudes.
 - There are 25 aircraft on the ground within a 5 NM radius of each TMA. Additionally, there are 25 aircraft not associated with a TMA randomly distributed through the scenario.
 - There are assumed to be 100 ground vehicles equipped with transmit-only UAT equipment.
- These aircraft are assumed to be symmetrically distributed azimuthally, and the aircraft in an altitude band are assumed to be uniformly distributed throughout the band. However, all aircraft in the same band are assumed to be traveling at the same band-dependent velocity.
- Superimposed over these aircraft is a set of airborne en route aircraft, which are distributed over a circle of radius 300 NM. These aircraft are distributed over four altitude bands, ranging from low to upper altitudes. They also travel at velocities that are altitude band dependent.
- As in the LA Basin 2020 scenario, for the Core Europe 2015 scenario all aircraft are assumed to be ADS-B equipped. The equipage levels have been adjusted to be:
 - 30 % A3
 - 30% A2
 - 30% A1
 - 10% A0

Aircraft equipage is assigned according to altitude. The lower percentages of A0 and A1 aircraft than those found in the LA Basin scenarios reflect differences in operating conditions and rules in European airspace.

The two geographical areas that underlie the scenarios discussed above (LA Basin and Core Europe) correspond to very different types of situations for an aircraft to operate in, and thus should provide two diverse environments for evaluation. The LA Basin scenario contains only about 14% of all airborne aircraft at altitudes above 10000 ft, while the Core Europe scenario has around 60% above 10000 ft. Thus, there will be vastly different numbers of aircraft in view for the two scenarios. Additionally, the aircraft density distributions are also quite different, which will place different stresses on the data link systems.

The results of simulation runs which correspond to the assumptions stated above for the full complement of 2091 aircraft and 500 ground vehicles are presented below. Recall that DME/TACANs on 978 MHz are assumed to have been moved, and that all potential and planned DME/TACANs on 979 MHz are assumed to have been implemented and transmit at maximum allowed powers. Two locations are considered for CE2015: one in the midst of worst-case UAT self-interference, in the center of the scenario over Brussels; the other in a location that is thought to represent the worst-case DME environment, over western Germany. In addition, the Baseline B Link 16 scenario is also assumed to

interfere with UAT transmissions in the CE2015 environment. Results are presented as a series of plots of 95% update times as a function of range for state vector updates. The 95% time means that at the range specified, 95% of aircraft will achieve a 95% update rate at least equal to that shown. The ADS-B requirements are also included on the plots for reference. Since the transmit power and receiver configuration are defined for each aircraft equipage class, performance is shown separately for each combination of transmit-receive pair types. In addition, performance of different transmit-receive pairs is shown at several different altitudes, where appropriate.

Results are presented in Figure B-23 to Figure B-33 for 95% update times as a function of range for state vector updates. Each point on the plot represents the performance of Aircraft/Vehicles within a 10 NM bin centered on the point. The UAT Requirements and Desired Features for state vector updates are shown as black lines on the plots. The maximum ranges specified for air-air update rates are: for A0 to 10 NM, A1 to 20 NM, A2 to 40 NM, and A3 to 90 NM (120 NM desired), while the criteria continue to 150 NM for A3. Air-ground requirements are defined to 150 NM for all aircraft equipage classes. Performance in compliance with requirements is indicated by results that are below the black line.

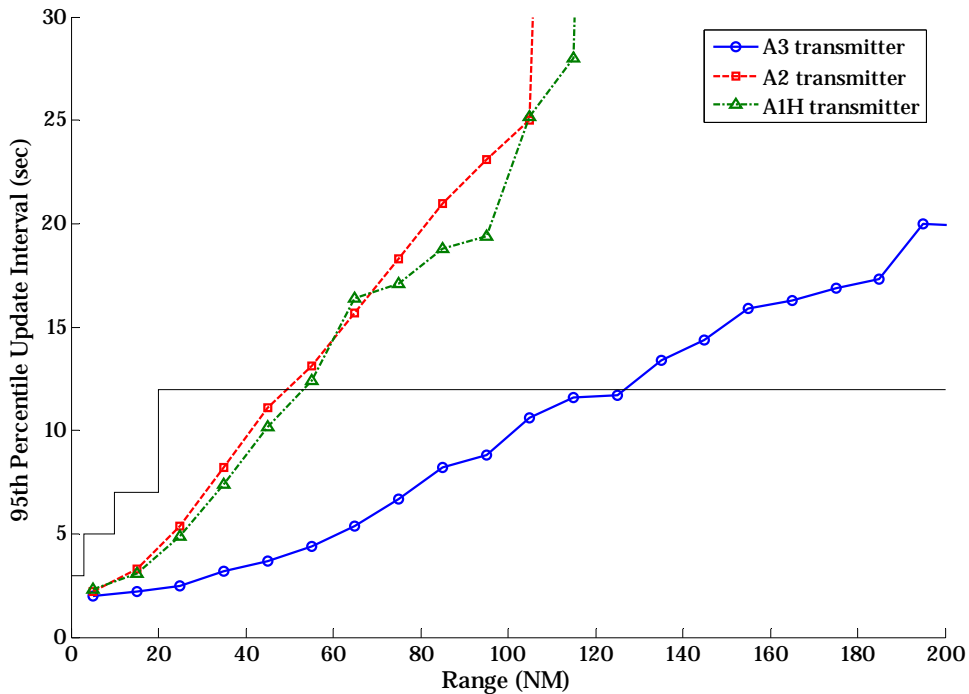

Figure B-23: Air-to-Air Reception by A3 Receiver at High Altitude over BRU in CE 2015

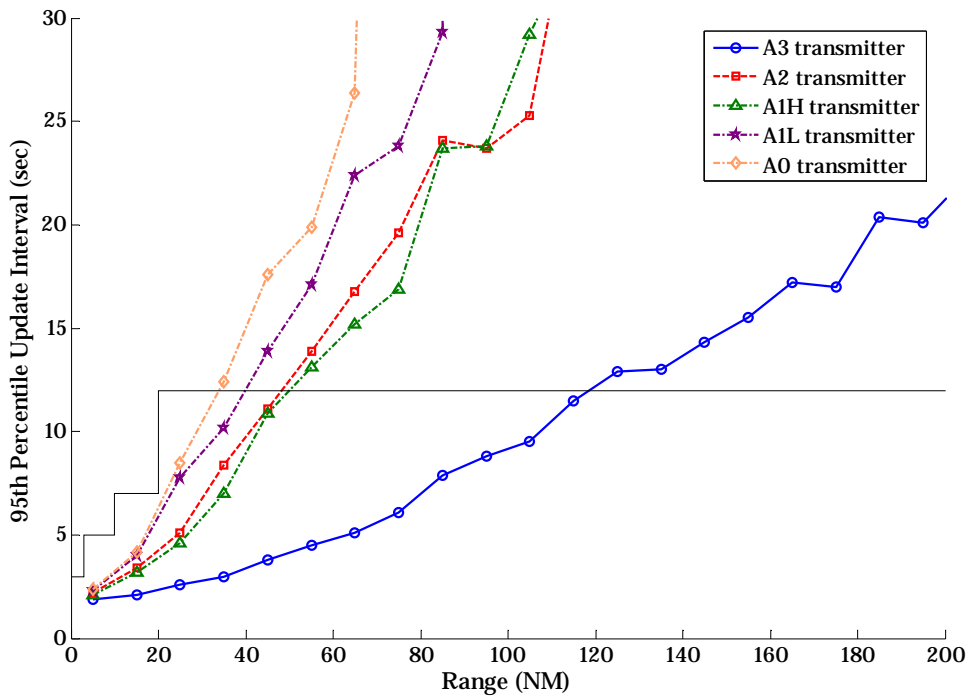

Figure B-24: Air-to-Air Reception by A3 Receiver at FL 150 over BRU in CE 2015

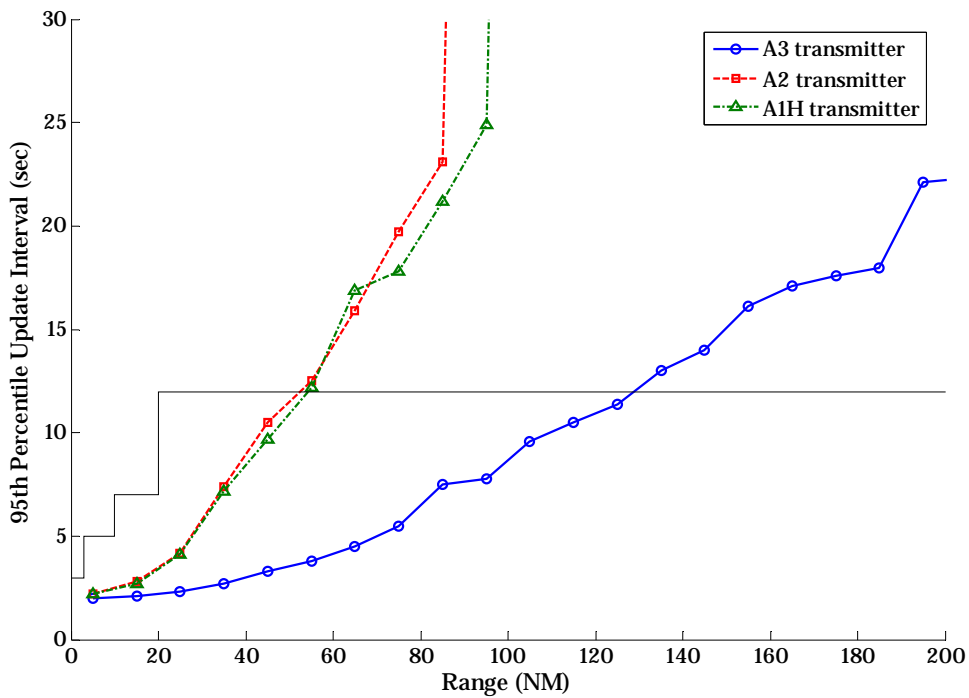

Figure B-25: Air-to-Air Reception by A2 Receiver at High Altitude over BRU in CE 2015

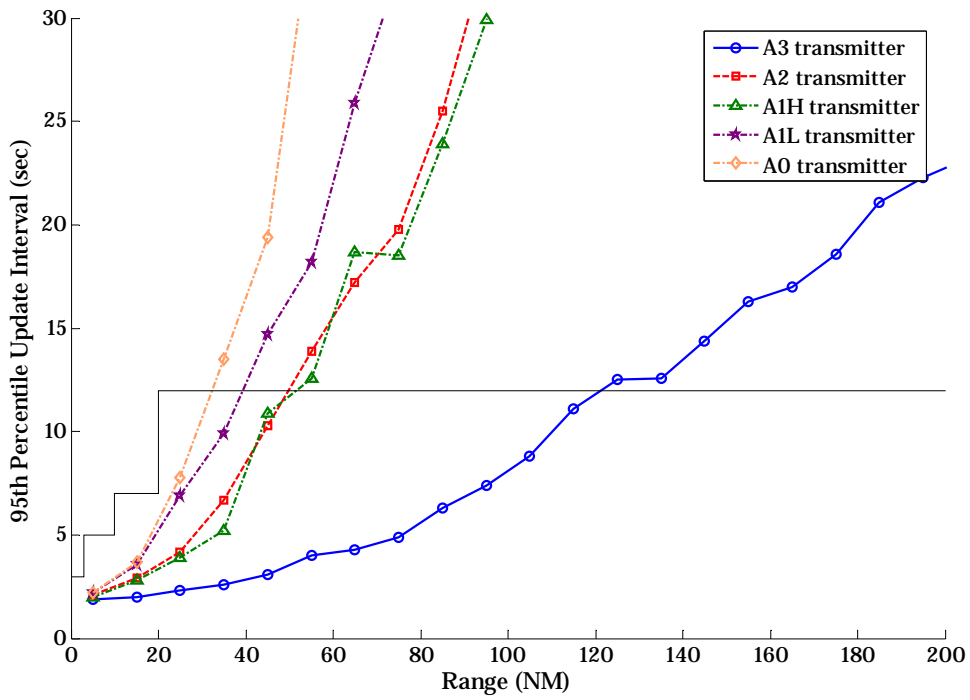

Figure B-26: Air-to-Air Reception by A2 Receiver at FL 150 over BRU in CE 2015

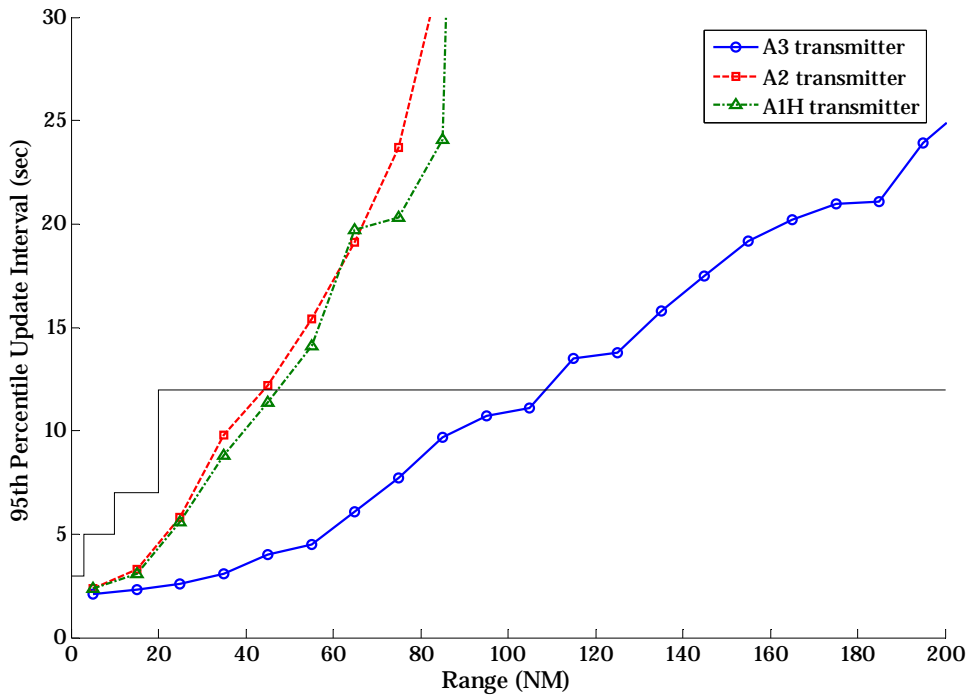

Figure B-27: Air-to-Air Reception by A1 Receiver at High Altitude over BRU in CE 2015

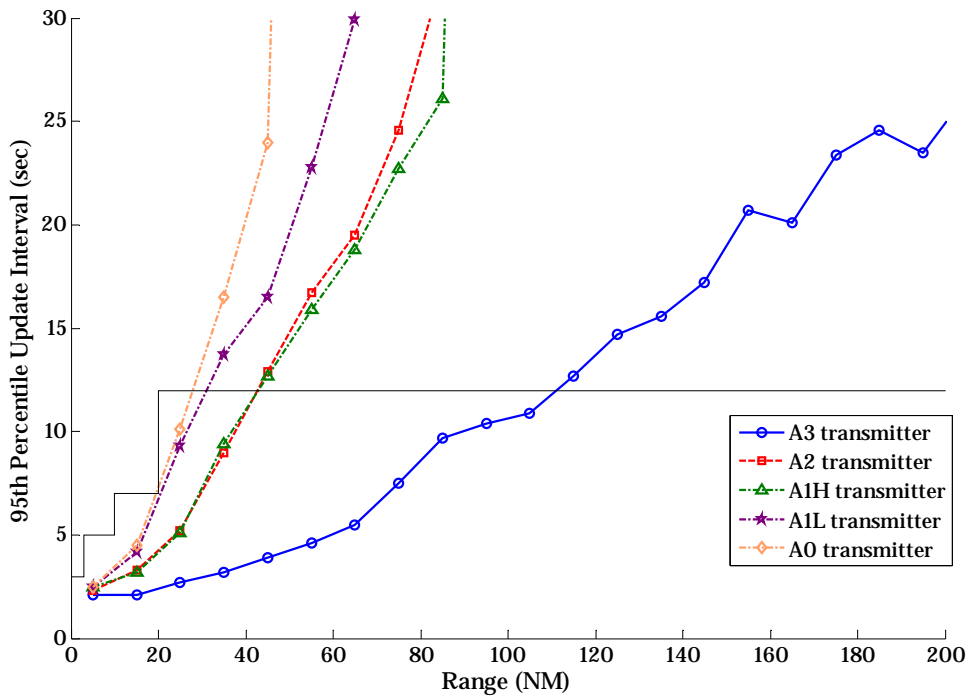

Figure B-28: Air-to-Air Reception by A1 Receiver at FL 150 over BRU in CE 2015

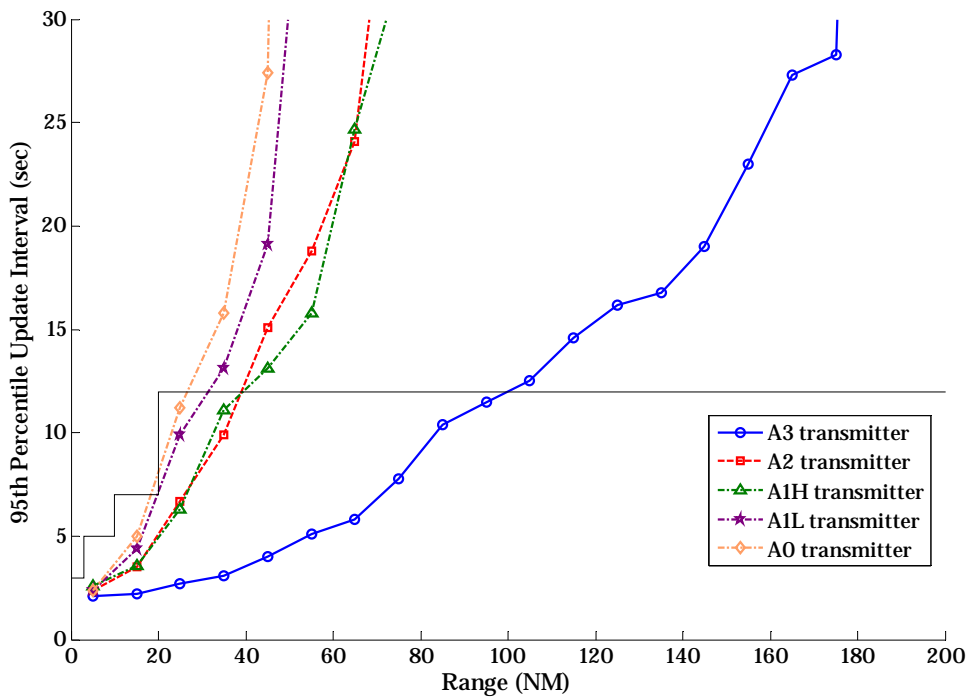

Figure B-29: Air-to-Air Reception by A0 Receiver at FL 150 over BRU in CE 2015

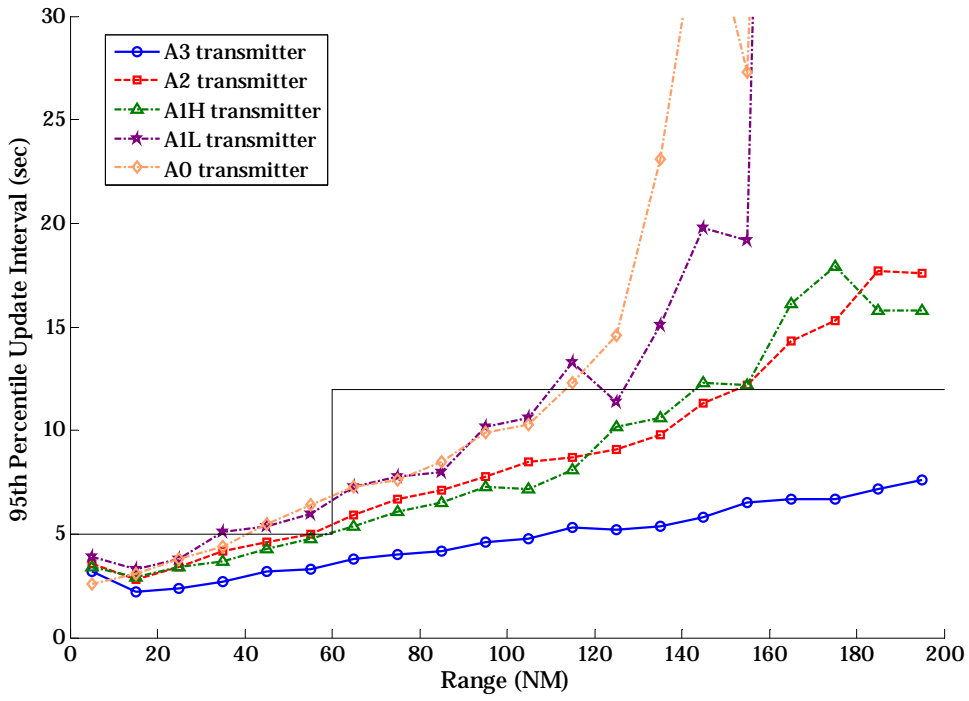

Figure B-30: Air-to-Ground Reception at BRU in CE 2015

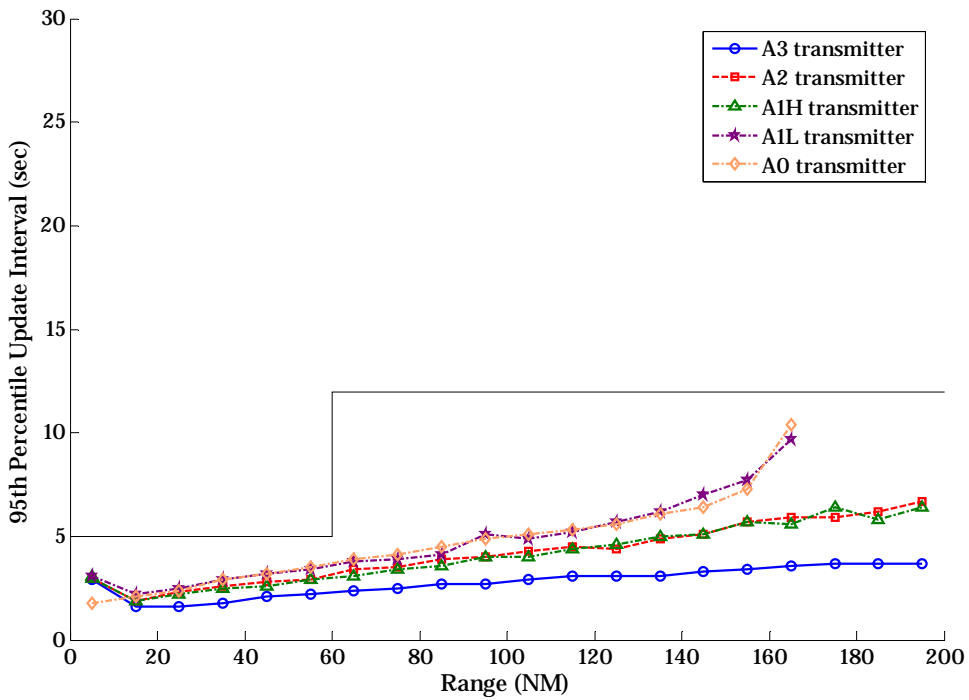

Figure B-31: Air-to-Ground Reception Using a 3-Sector Antenna at BRU in CE 2015

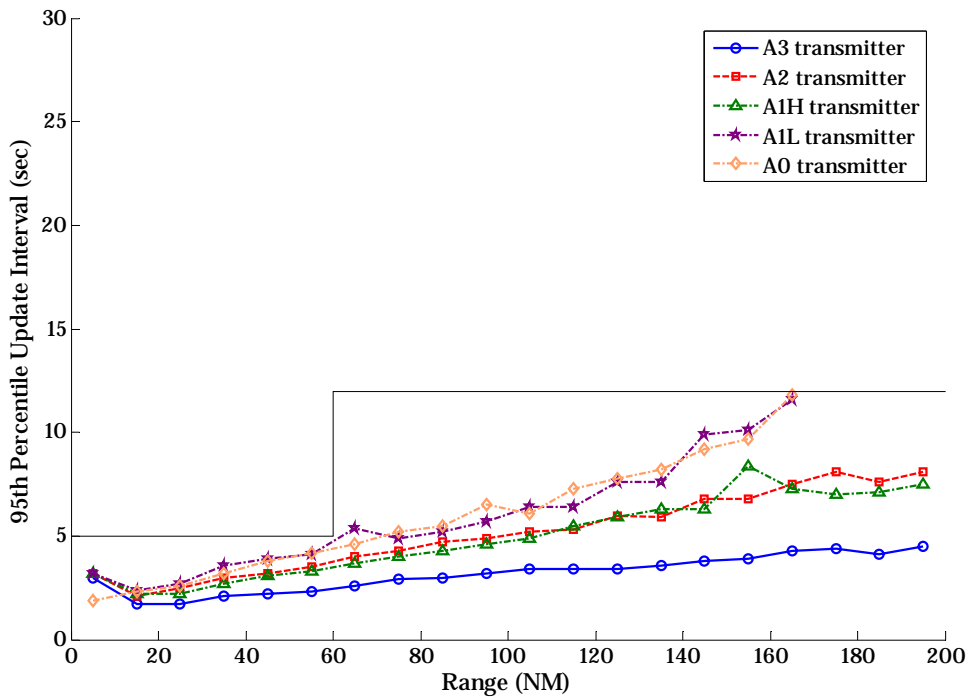

Figure B-32: Air-to-Ground Reception 2 NM from a 10 kW TACAN Using a 3-Sector Antenna at BRU in CE 2015

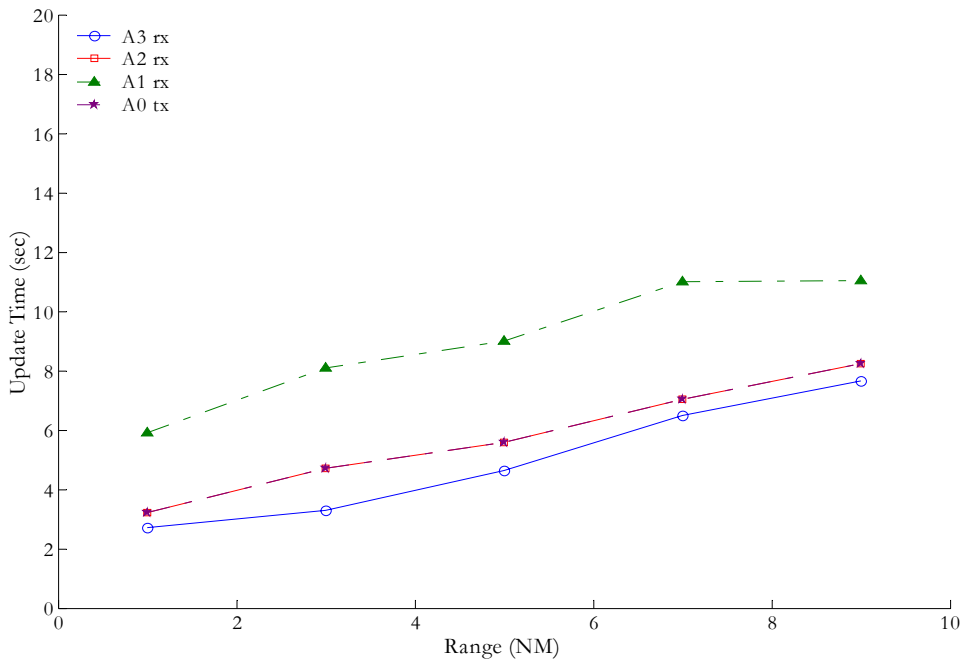

Figure B-33: Reception of Ground Vehicle Transmissions by Aircraft on Approach at 2000 feet into BRU in 2015 with 10 kW 979 MHz TACAN at Airport

Recall that the CE2015 scenario includes 2091 aircraft and 500 ground vehicles transmitting on UAT. The DME/TACAN interference environment is characterized by up to four adjacent-channel emitters, all at the maximum allowable powers. In addition, a baseline Link 16 scenario is also included as co-channel interference.

The UAT air-air performance in Core Europe shown in Figure B-23 through Figure B-29 is summarized in Table B-2. This summary indicates that the UAT System is projected to be fully compliant with the ADS-B air-to-air report update requirements at both the required and desired ranges.

Table B-2: Ranges of ADS-B Compliance for UAT Transmit-Receive Combinations in CE 2015 Scenario

RECEIVER	TRANSMITTER			
	A3	A2	A1	A0
A3 (High Altitude)	120	40+	40+(A1H)	NA
A3 (FL 150)	120	40+	40+(A1H)/30+(A1L)	20+
A2 (High Altitude)	130	50	50(A1H)	NA
A2 (FL 150)	120	40+	40+(A1H)/30(A1L)	20+
A1 (High Altitude)	100+	40	40+(A1H)	NA
A1 (FL 150)	110	40	40(A1H)/20+(A1L)	20+
A0	100	30+	30+(A1H)/20+(A1L)	20+

The results for Core Europe 2015 shown in Figure B-23 through Figure B-33 may be summarized as follows:

- ADS-B air-air requirements and desired criteria are met for all aircraft equipage transmit-receive pairs for both state vector update rates at all ranges specified by the UAT Requirements and Desired Features.
- The extension to 150 NM for A3 equipage is not met at the 95% level, but the 95% state vector update time at 150 NM is 15-16 seconds, depending on receiver altitude and location. The 95% level is achieved to around 120 NM, depending on receiver altitude and location.
- All known air-ground update rate requirements are substantially met for all classes of aircraft out to at least 150 NM, even in the presence of a co-located TACAN emitter, by using a three-sector antenna. A test case was run, which included a 10 kW co-located 979 MHz TACAN. It was determined that the TACAN signal at the receive antenna had to be received at a level that did not exceed -30 dB, in order for all equipage classes to meet air-ground requirements. This corresponds to an isolation of 20 dB from the receive antenna, in addition to that provided by a 50 foot separation distance between the TACAN transmitter and ground receiver plus isolation provided by the receive antenna null. This could be achieved by increasing the separation distance, for example.
- System performance results are presented for updates of ground vehicles to an aircraft on approach. We know of no specific ADS-B requirements for this situation.

B.4.3 Low Density Scenario

In addition to the two high-density scenarios described above, a scenario was also run to represent low-density traffic levels. This scenario was developed for 360 total aircraft. These aircraft are uniformly distributed in the horizontal plane within a circle of radius

400 nautical miles. In the vertical direction, they are distributed uniformly between 25,000 feet and 37,000 feet. The velocities are all set to 450 knots and are randomly distributed in azimuth. All of the aircraft are assumed to be A3 equipped. In order to evaluate the performance of a ground receiver in this environment, one was located at the center of the scenario, along with a co-located TACAN transmitter at 979 MHz.

Results of the MAUS runs for the low-density scenario are shown in Figure B-34 and Figure B-35, and conclusions are presented below. The ADS-B requirements for state vector updates are shown as black lines on the plots. The requirements specify that the maximum ranges for air-air update rates required for A3 to 90 NM (120 NM desired), while the criteria are extended on the plot to 150 NM. Performance in compliance with requirements is indicated by results that are below the black line.

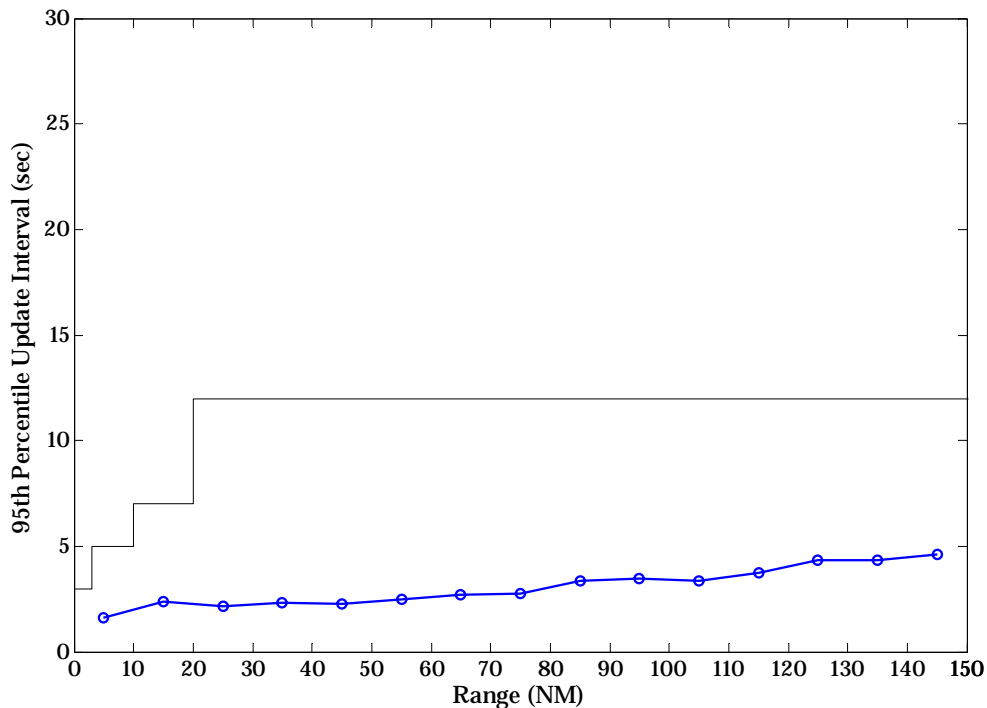

Figure B-34: A3 Receiver in Low Density Scenario Receiving A3 Transmissions

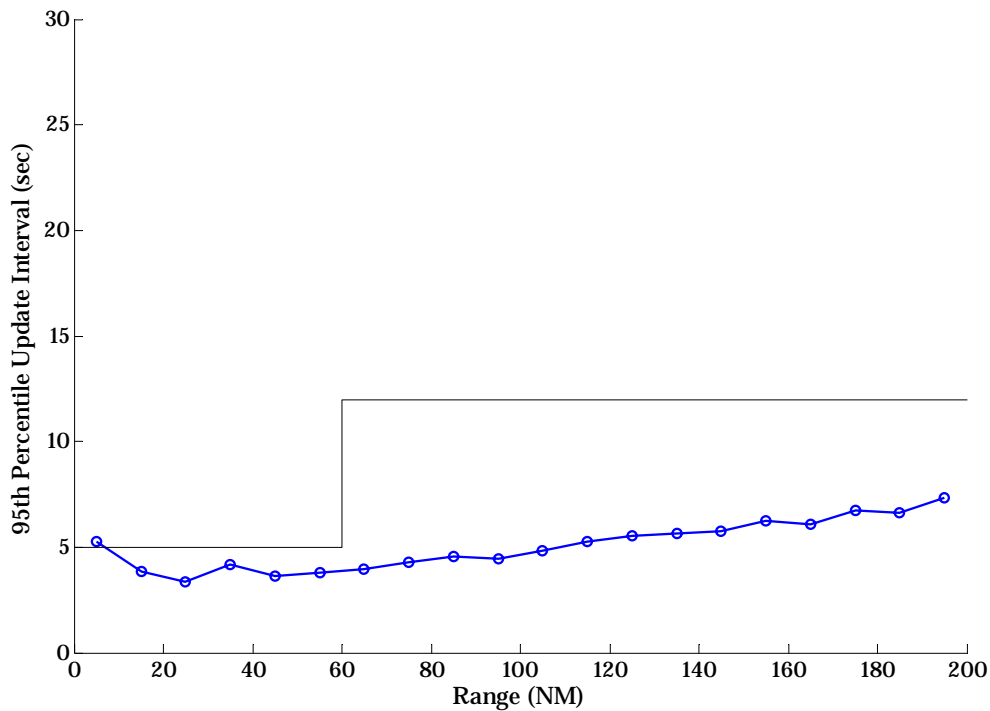

Figure B-35: Receptions of A3 Transmissions by a UAT Ground Receiver in a Low Density Scenario co-located with a TACAN at 979 MHz with -30 dBm Power at the UAT Antenna

The results for the low-density scenario may be summarized as follows:

- ADS-B air-air requirements and desired criteria are met for all aircraft for both state vector and intent update rates at all ranges specified by the UAT Requirements and Desired Features.
- The extension to 150 NM for A3 equipage is met at the 95% level, as required.
- All known air-ground update rate requirements are met out to at least 150 NM, in the absence of the co-located TACAN emitter, with the use of a single antenna on the ground. A test case was run, which included a 10 kW co-located 979 MHz TACAN. It was determined that the TACAN signal at the receive antenna had to be received at a level that did not exceed -30 dBm, in order to meet air-ground requirements. This corresponds to an isolation of 20 dB from the receive antenna, in addition to that provided by a 1000 foot separation distance. Alternatively, a three-sector ground antenna configuration should also enable satisfaction of the air-ground requirements to 150 NM.

B.4.4 Acquisition Performance

Performance of the UAT ADS-B system in the area of aircraft information acquisition was evaluated. In a head-on situation in the LA2020 scenario, the 99th percentile range for acquisition by the victim receiver of all information transmitted on ADS-B by the desired aircraft was determined for each aircraft equipage type. This was done for a large sample of cases, and the 99th percentile case was chosen. In other words, 99% of aircraft are expected to achieve a 99% probability of acquiring all information about an aircraft flying on a head-on path by the range selected.

The information necessary to acquire varies by aircraft equipage, so the evaluation was done for various transmitter-receiver combinations of equipage. For each equipage type, the message transmit sequence used was that defined in Section 2.2.6.1.3. Table B-3 shows the assumptions made in this analysis for information required to achieve acquisition for each type of transmit equipage.

Table B-3: Acquisition Requirements

Transmit Equipage	Required Information for Acquisition
A3	SV, MS, TSR, TCR0, TCR1
A2	SV, MS, TSR, TCR0
A1H	SV, MS, TSR
A1L	SV
A0	SV

The abbreviations used in Table B-3 are:

- SV: State Vector
- MS: Mode Status
- TSR: Target State Report
- TCR0: Trajectory Change Report 0
- TCR1: Trajectory Change Report 1

The methodology used in this analysis was to run a set of probe aircraft in a head-on scenario and determine, for each, probe aircraft, the 99th percentile range at which all of the above information was received by the victim aircraft. The results are shown in Table B-4 for each transmit-receive combination.

Table B-4: 99th Percentile Range for Information Acquisition for Various Combinations of Transmit-Receive Pairs (NM)

Receiver	Transmitter					
		A3	A2	A1H	A1L	A0
A3		137	53	53	49	18
A2		145	54	53	52	17
A1		122	50	48	37	11

These results are for somewhat more restrictive acquisition criteria than are usually applied. From the results, it appears that UAT will be able to comply with all known ADS-B track acquisition requirements.

B.4.5 Surface Performance

An evaluation was performed of the performance of the UAT system on the surface, i.e., aircraft-to-aircraft state vector update rates were determined for transmit-receive pairs on the ground at LAX in the LA2020 scenario. The aircraft separation was varied between

one and five nautical miles, and cases were run with and without severe horizontal surface multipath included. The multipath model used is described in Appendix M.6 of the ADS-B Technical Link Assessment Team (TLAT) Technical Link Assessment Report, March, 2001. It was thought that these two cases would provide conservative bounds on expected performance, since it was assumed that the severe multipath effects would always interfere destructively with the received signal.

Recall that the LA2020 scenario, in addition to a total of 2694 aircraft (75 on the ground at LAX) transmitting UAT, includes 100 transmitting ground vehicles at LAX as well. The results for the analysis of aircraft-to-aircraft surface-to-surface performance may be summarized as follows:

- For the bounding cases with no multipath and with worst-case elevation plane multipath, the 95th percentile surface update requirement for the UAT Requirements and Desirable Features (1.5 seconds out to 5 NM) are met for A3 transmitters up to 1-2 NM away.
- The 95th percentile surface update requirement (1.5 seconds out to 5 NM) is not met for all other cases on the surface.
- The 95th percentile update time on the surface for all aircraft classes to 5 NM for the bounding case of no multipath is approximately 2 seconds. A3 transmitters can be seen by A2 and A3 receivers out to 5 NM with, approximately, a 3 second 95th percentile update time. A2 transmitters can be seen by A2 and A3 receivers out to 5 NM with, approximately, a 5 second 95th percentile update time.
- The 95th percentile update time on the surface for all aircraft classes for the bounding case of worst-case multipath is approximately 3 seconds at a range of 1 NM. The limiting factor at ranges greater than 1 NM is the transmit power and antenna placement for A0 and A1L class equipment, combined with the effect of 175 interferers at close range.

B.4.6 An A0 on the Surface Receiving an Aircraft that is on Approach

An evaluation was performed of the performance of the UAT system for an aircraft on the surface receiving state vector transmissions from aircraft on landing approach in both the LA2020 and Core Europe 2015 scenarios. The aircraft on approach were modeled at an altitude of 2000 feet. The receiving aircraft on the ground is equipped as an A0 receiver. It was thought this would provide a worst case performance for aircraft on the surface receiving airborne transmitters due to the A0 receiver potentially only having a single antenna on the bottom of the aircraft. No multipath was included.

The evaluation was performed using the same co-site interference environment as for the airborne scenarios. In practice, the actual interference environment would be more benign, because of much lower instances of interrogations from TCAS/ACAS and radar ground systems when operating on the surface, and potentially from a lack of DME equipment on some portion of the A0 and A1L fleet. In addition, the Core Europe scenario had a 10 kW 979 MHz TACAN located 1000 feet away from the UAT receiving antenna.

Results of the MAUS runs for an A0 aircraft on the ground receiving UAT transmissions from aircraft on approach are shown in Figure B-36 and Figure B-37 for the LA2020 and CE 2015 scenarios, and conclusions are presented below. We know of no specific ADS-B requirements for this situation.

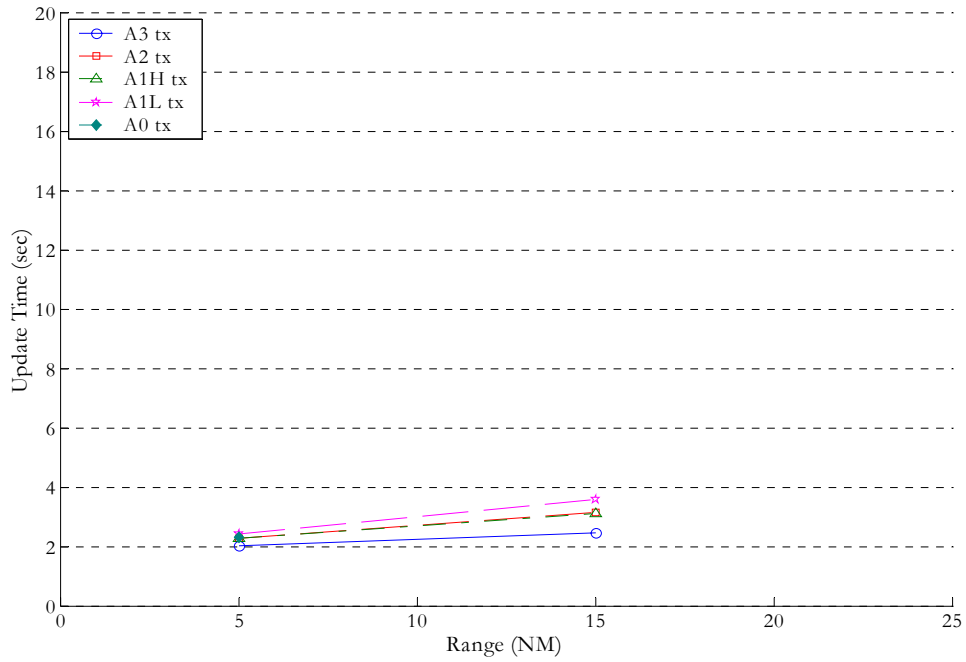

Figure B-36: A0 Receivers on the Ground in LA2020 Receiving All Aircraft on Approach at an Altitude of 2000 feet

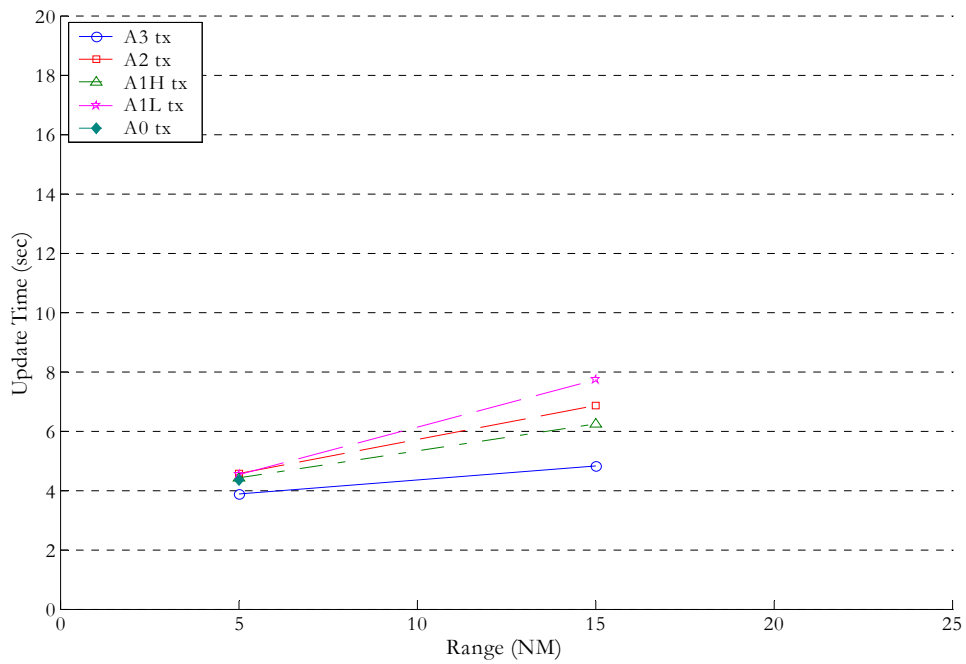

Figure B-37: A0 Receivers on the Ground in CE2015 Receiving All Aircraft on Approach at an Altitude of 2000 ft to Brussels co-located with a 10 kW 979 MHz TACAN

Recall that the LA2020 scenario, in addition to a total of 2694 aircraft (75 on the ground at LAX) transmitting UAT, also includes 100 transmitting ground vehicles at LAX as well. Furthermore, the CE2015 scenario has 2091 aircraft transmitting UAT, including 25 aircraft and 100 ground vehicles on the surface in Brussels.

B.4.7 TIS-B Performance of UAT in the LA 2020 Environment

An analysis was performed to investigate UAT ground-to-air performance of TIS-B uplinks in the high density air traffic environment of LA 2020 (see Section B.4.1 for a description of the LA 2020 scenario). This section presents the results of that work. Section B.4.7.1 reviews many of the additional assumptions necessary to describe the system under study, and Section B.4.7.2 summarizes the results of the analysis.

B.4.7.1 Additional TIS-B Assumptions

This section describes additional assumptions (to those described in Section B.4.1 for the LA 2020 scenario), which were necessary to describe a more complete ground infrastructure for the UAT system. It addresses the number and locations of UAT ground stations, their basic operation, and the TIS-B transmissions from these ground stations.

A total of 21 locations for UAT ground stations were selected for the Los Angeles Basin region defined for the LA 2020 scenario. Most of these were selected to be located at various airports in the area. Each of these stations was responsible for the aircraft in a defined service volume, as shown in Figure B-38 below.

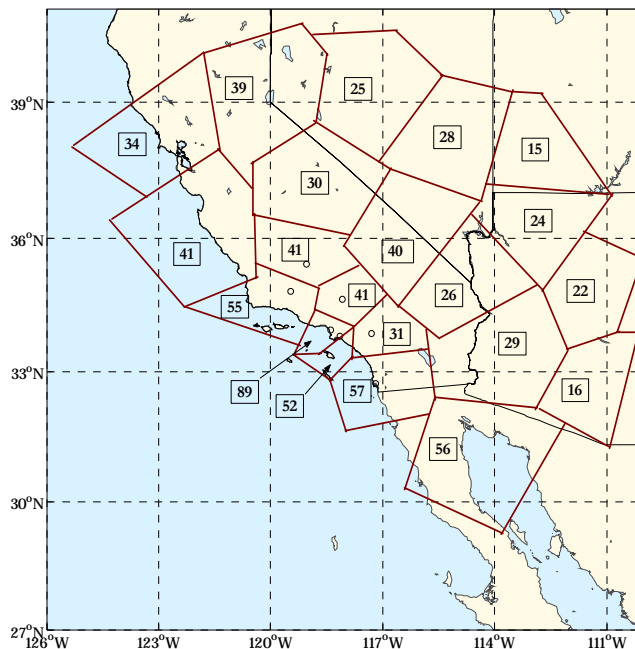

Figure B-38: Locations of UAT Ground Stations, Including Service Volumes and Number of Uplinks per Second (2008) in Each Service Volume for LA 2020 Scenario

TIS-B transmissions were assumed to be made in the ADS-B segment of the UAT frame by the ground stations, using two possible scheduling algorithms. One was the so-called “Capstone” algorithm, because it reflects the technique implemented for the UAT ground stations acquired for the Capstone program. The other algorithm studied was a simple random selection method.

Two operational time frames were investigated: near-term (2008) reflecting no ADS-B equipage, with TIS-B updates provided by radar reports; and 2020, assuming 100% ADS-B equipage (40% 1090 ES and 60% UAT), with TIS-B updates provided by ADS-B rebroadcast (ADS-R). The radar updates occurred once every 1.2 to 4.8 seconds, depending on the altitude of the aircraft, while ADS-R updates were assumed to be provided at a constant rate of once per second.

TIS-B uplinks were assumed to begin at a MSO, and were further assumed to consist of a long ADS-B message. The ground station transmit power was assumed to be 45 dBm, with an antenna gain pattern that is omni-directional in azimuth and TACAN in elevation. A number of airborne receivers were studied, but the results reported here are for the worst-case A1 receiver type.

B.4.7.2 TIS-B Results

Figure B-39 shows the results for the 95% TIS-B update interval for a receiver located at a worst case position in the near term (2008) scenario, receiving TIS-B messages from LAX. There are three sets of outcomes shown on the graph, representing the update intervals for the three different radar detection intervals: 1.2 seconds, 2.4 seconds, and 4.8 seconds. For each detection interval, results are shown for both a single UAT transmission for each update and for two transmissions per update. For this scenario, there appears to be little difference in UAT TIS-B uplink performance between the two algorithms, although in this high density air traffic environment with low ADS-B equipage, repeating the TIS-B uplink message does seem to provide an important advantage.

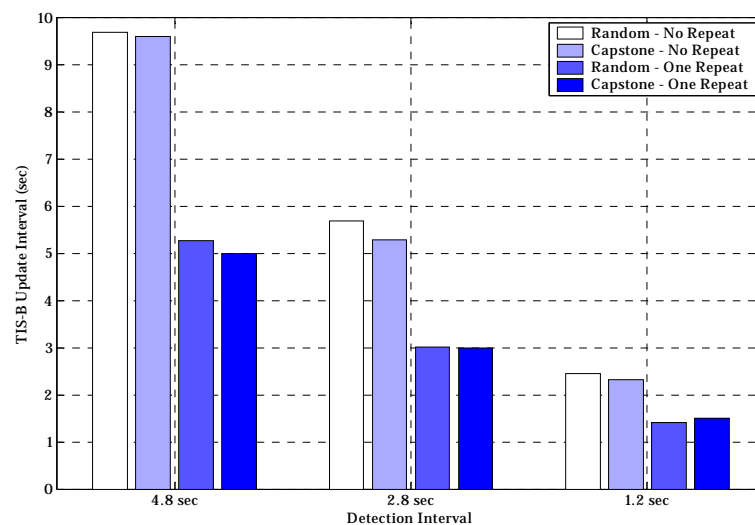

Figure B-39: TIS-B 95% Update Intervals in LA 2008 (No ADS-B Equipage)

The ADS-B air-to-air UAT performance is affected by the large amount of TIS-B uplink traffic coming from the UAT ground stations in this near-term scenario. However, as shown in Figure B-40, the effect is not sufficiently large to cause the performance to exceed the required ADS-B 95% update time.

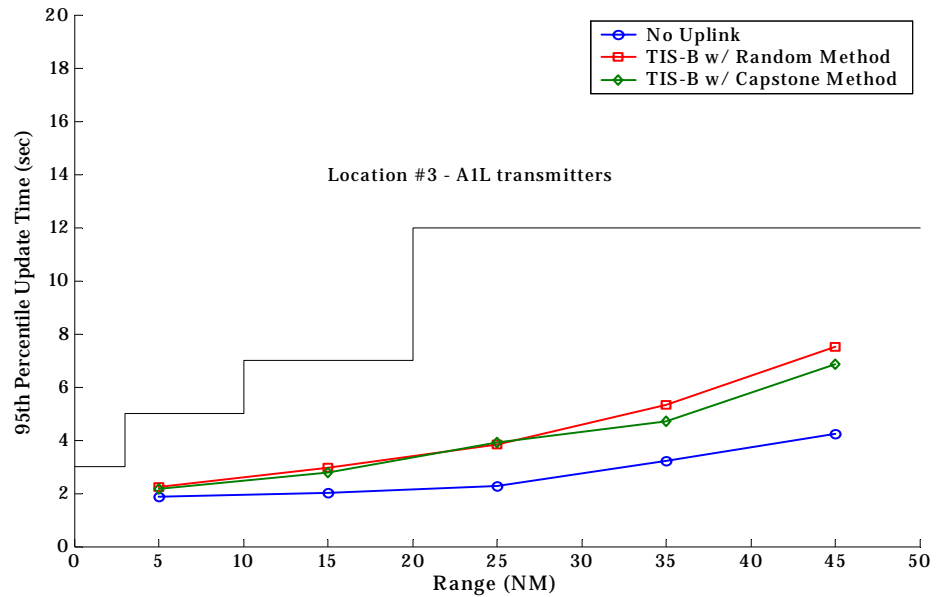

Figure B-40: ADS-B 95% Update Interval in Near-Term Scenario

For the LA 2020 scenario, all aircraft are assumed to be ADS-B equipped with either 1090 ES or UAT, so all ground uplinks are ADS-R and updates are assumed to occur every second for each 1090 ES-equipped aircraft. Table B-5 below shows the 95% update time for the ADS-R transmissions as received at an airborne receiver located near a number of ground stations in the dense central area of the scenario. Note that the 95% time for the Capstone slot selection algorithm is around two seconds for all of the ground stations.

Table B-5: 95% Update Times for ADS-R Transmissions from UAT Ground Stations in LA 2020

Ground Station	Uplinks per sec	Range (NM)	Random	Capstone
1 (LAX)	89	36.6	2.3	2.0
5	55	38.2	2.5	2.0
6	41	33.6	2.3	2.0
7	41	51.2	3.0	2.1

Figure B-41 shows the effect of the ADS-R transmissions from the ground stations on the ADS-B air-to-air performance of A1L transmitters to the A1 airborne receiver. Note that there were four algorithms tested for this case, and all made the ADS-B air-to-air performance worse than with no ground transmissions, but none caused the ADS-B performance to exceed the required 95% update time.

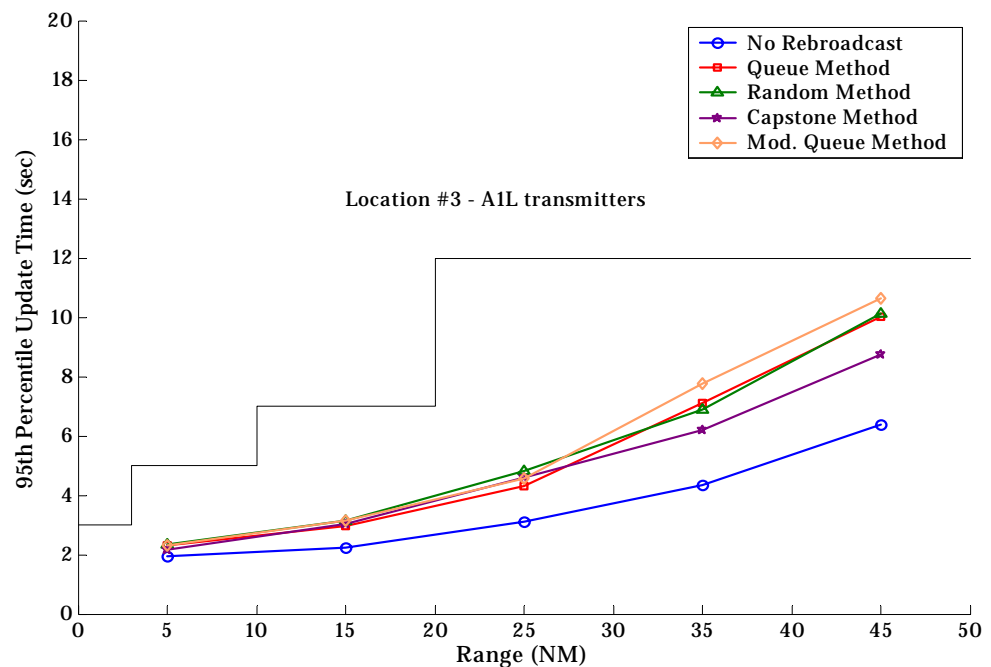

Figure B-41: ADS-B Air-to-Air Performance in the Presence of ADS-R Ground Transmissions in LA 2020

B.4.7.2.1 TIS-B Hotspot Analysis

This section discusses the performance of an A3 receiver in the Core Europe 2015 traffic scenario (CE2015) attempting to receive ADS-B messages from one other airborne UAT transmitter in an extreme TIS-B interference environment. This is intended to be a worst case analysis of the early transition to ADS-B in which most aircraft are not equipped with UAT transmitters. The term 'hotspot' has been used to describe the effect to be simulated here, where one ground-based transmitter generates all TIS-B message traffic (in the ADS-B segment of the one-second frame) rather than the distributed nature of the

airborne transmitters in the standard CE 2015 scenario. It is the intention of this section to estimate the effect that this hotspot has on airborne ADS-B performance in CE 2015.

To estimate the worst-case of TIS-B uplinks providing interference, it was assumed that only two aircraft are equipped with ADS-B in the CE2015 scenario. In the CE2015 scenario, there are approximately 1000 aircraft within line-of-sight of a ground station at Brussels. Therefore, for the worst case the ground station is assumed to transmit 1000 TIS-B messages per second in the ADS-B segment of the UAT frame. Other cases, where the ground station transmits fewer than 1000 messages/second, are also reported. In addition to the TIS-B interference, Link 16 Baseline B, co-site and the appropriate DME interference are all assumed to be present.

Figure B-42 shows 8 curves for ADS-B air-to-air 95% state vector update times which correspond to varying the distance between the ground station and the receiving aircraft. Note that the worst case appears at a distance of around 40 NM, which is due to the combination of the signal propagation loss and the ground station antenna peak.

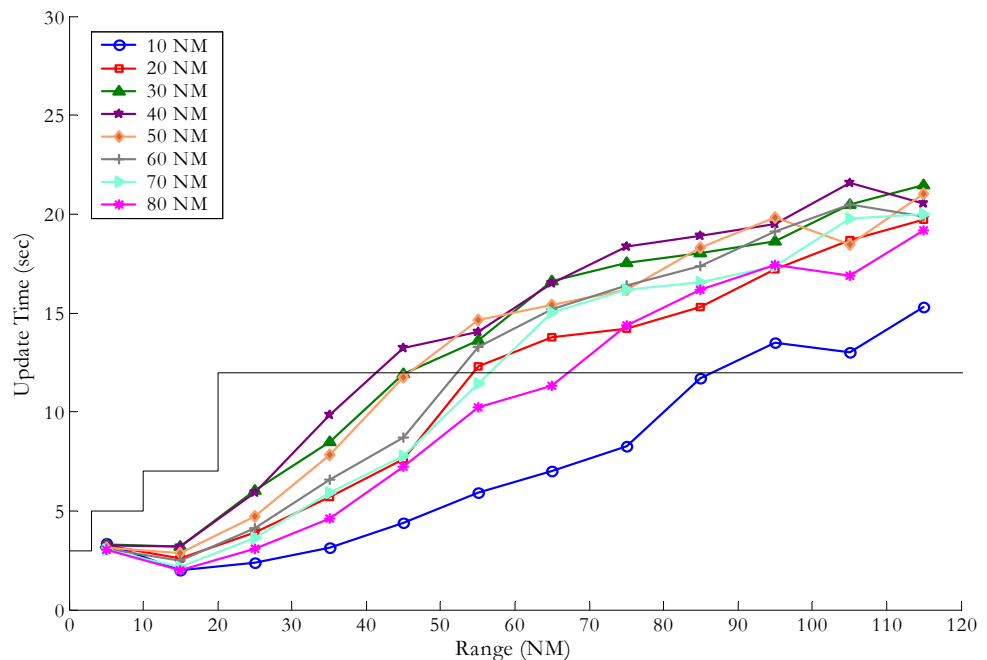

Figure B-42: 95% State Vector Update Times for an A3 Receiver at 40,000 feet Receiving A3 Transmissions in the Presence of a Ground Station at Various Ranges Broadcasting 1000 TIS-B Messages Per Second

Figure B-43 shows the effect of decreasing the uplink rate for TIS-B transmissions. In this figure, 500 messages are uplinked each second, which might correspond to transmitting TIS-B information for 1000 targets every other second or to sending up the closest 500 targets once per second. Results at all ranges from the ground transmitter are compliant with the UAT Requirements and Desirable Features to farther than 120 NM.

In both Figure B-42 and Figure B-43, the 95th percentile update time is highest at all A3-A3 ranges when the ground station is 40 NM away from the receiver. Based on this result, another simulation with a

different transmit rate (800 uplinks per second) was run with the ground station 40 NM away from the receiver, in an attempt to estimate the uplink rate at which compliance with UAT requirements breaks down. The results from the previous figures are compared with the 800 messages per second results in Figure B-44. The 800 uplink messages per second results show what appears to be minimal compliance with UAT requirements.

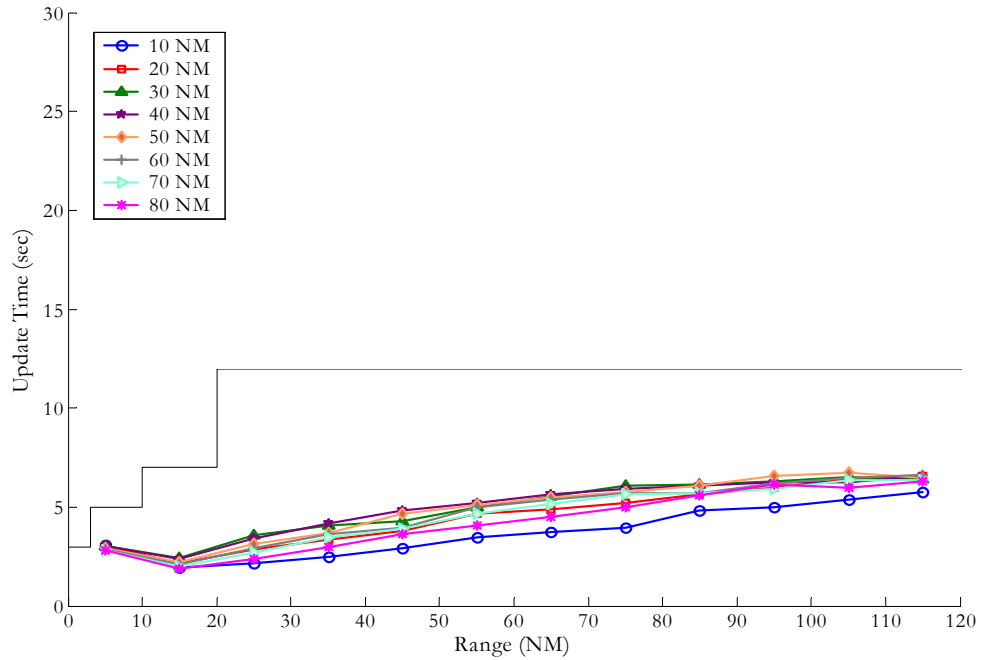

Figure B-43: 95% State Vector Update Times for an A3 Receiver at 40,000 feet Receiving A3 Transmissions in the Presence of a Ground Station at Various Ranges Broadcasting 500 RIS-B Messages Per Second

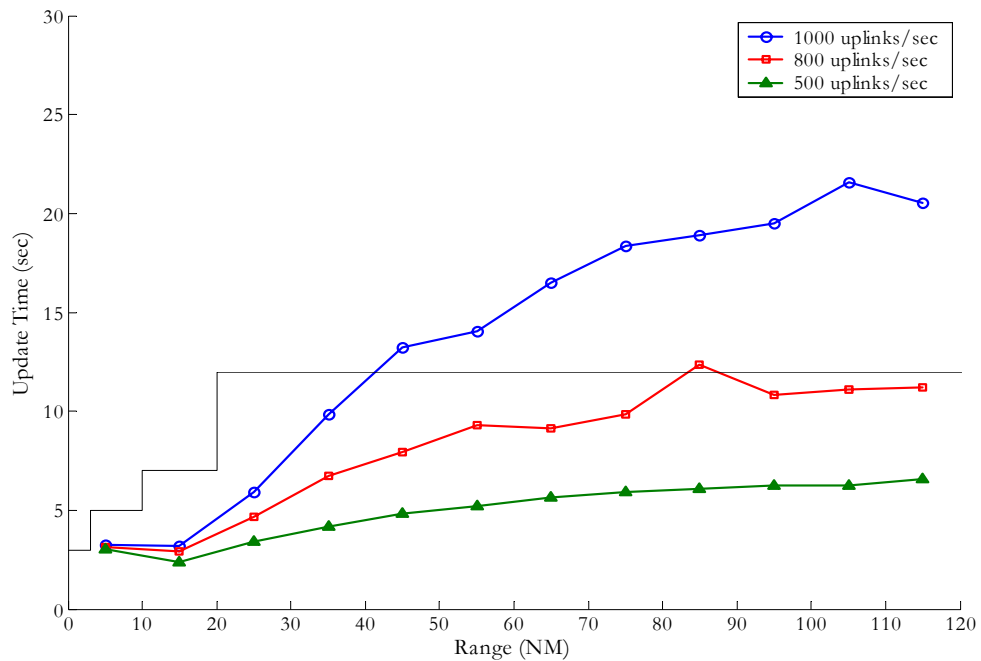

Figure B-44: 95th Percentile State Vector Updates Times for an A3 Receiver at 40,000 feet Receiving A3 Transmissions in the Presence of a Ground Station 40 NM Away at Various Uplink Rates

These results provide guidance for a potential limit on the TIS-B uplink transmission rate that can be supported in this high air traffic density type of environment. In principle, the analysis shows that, during the period of transition from no ADS-B equipage to more substantial equipage rates, a level of 800 uplink messages/second from a single UAT ground station should allow the UAT required update rates to be achieved for air-air reception.

B.5 Model Validation

The validation effort for MAUS focused on reproducing a complete interference environment. The United States Federal Aviation Administration's (FAA) William J. Hughes Technical Center (FAATC) developed a UAT interference simulator, which was capable of reproducing both the LA2020 and CE2015 UAT self-interference environments. The additional capability of simultaneously inserting DME and Link 16 interference along with the UAT self interference was also implemented, resulting in emulation of high density, stressful environments containing a combination of all three types of interference. This simulator, along with "desired" UAT messages were combined and fed into UAT MOPS compliant UAT receivers. The Message Success Rate (MSR) was then measured as a function of desired signal level for various combinations of interference, and compared with predictions of the MAUS for identical circumstances and assumptions. In all cases, the predictions of the MAUS were in agreement with the measured results, within the experimental uncertainties. An example of this comparison is shown in Figure B-45 for the LA2020 UAT self interference environment. The results comparing measurements taken at the FAATC and the Joint Spectrum Center of the Defense Information Systems Agency (JSC) on UAT MOPS compliant equipment with MAUS simulation results are shown in Figure B-45.

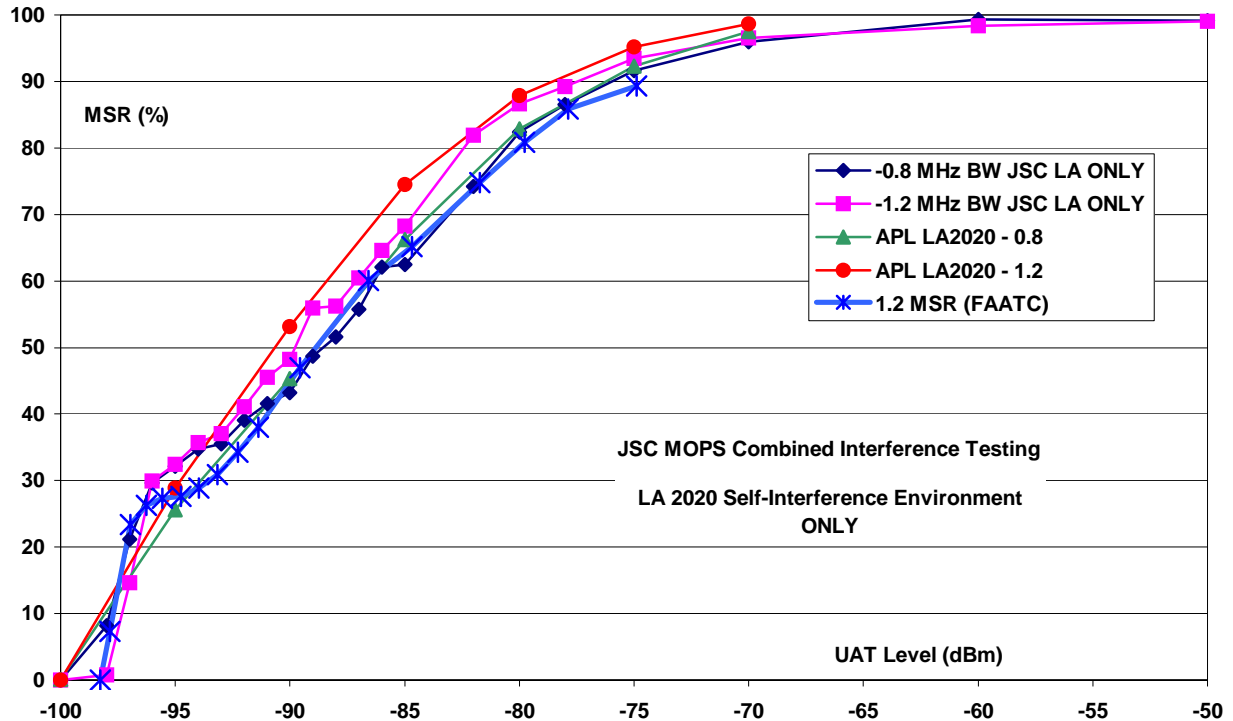

Figure B-45: Comparison of Bench Test Measurements of MOPS-Compliant UAT Reception in LA2020 Self-Interference with Predictions by MAUS

As is evident from Figure B-45, there is very little difference between the bench test data and the predictions of the MAUS. The two sets of data are quite consistent with each other within the limits of measurement. It is important to note that there were no free parameters that needed to be adjusted to achieve this agreement. This type of validation provides an increased measure of confidence in the simulation predictions.

Bench test measurements were also made of the Core Europe environment, which included UAT self-interference, DME/TACAN interference, and Link 16 interference. Results of these measurements are shown in Figure B-46 and Figure B-47. Figure B-46 shows the measurement results for the 0.8 MHz filter receiver, which is to be used for A3 class equipment. The addition of Link 16 interference to the DME/TACAN and UAT interference results in a reduction in MSR of up to around 10% for a given desired signal level, although the curves are much closer than that over much of the signal range. Simulation results have not been run for comparison in this scenario; however, there is a slight reduction in performance when Link 16 interference is added to the identical Core Europe scenario.

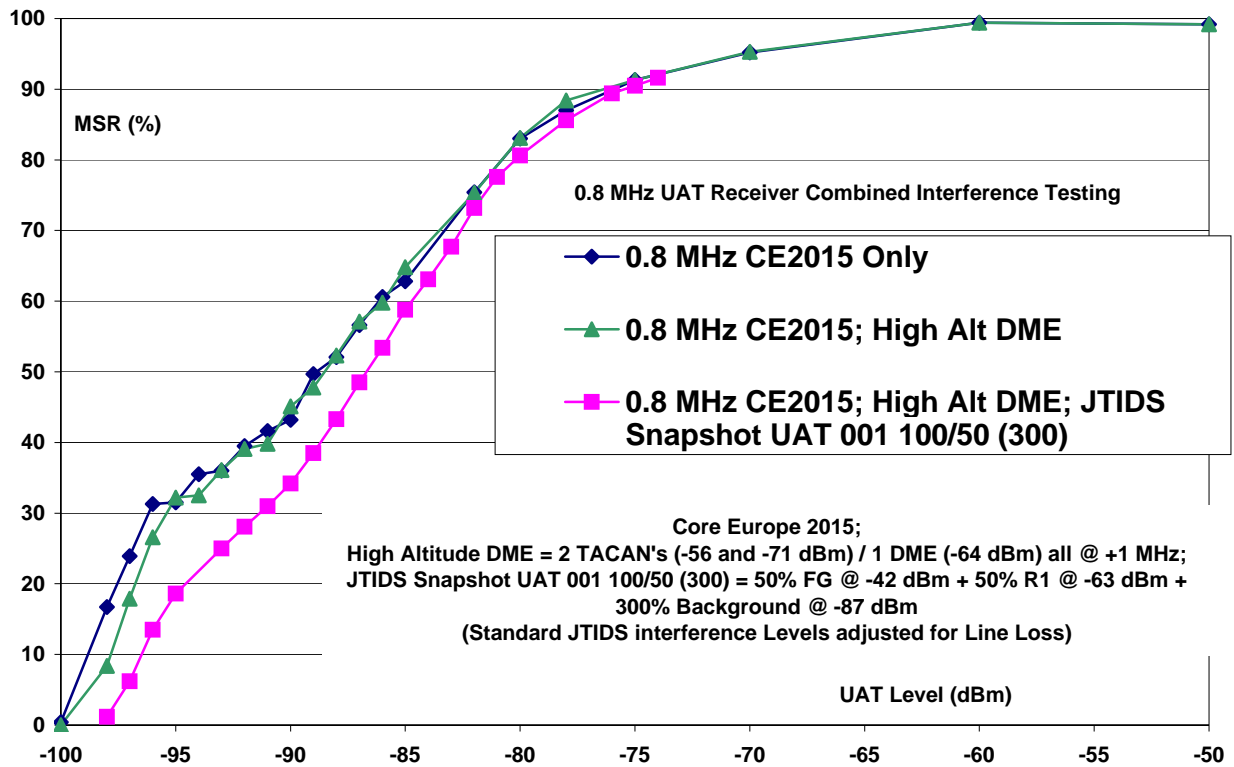

Figure B-46: Bench Test Measurements of UAT Performance in Core Europe UAT Self-Interference, Combined with DME/TACAN and Link 16 Interference

Figure B-47 shows the results for measurements taken with the 1.2 MHz receiver filter, which corresponds to the receiver used for all equipage classes other than A3. These results are similar in nature to those for the Core Europe scenario shown in Figure B-46, in that the addition of Link 16 interference results in a small reduction of the MSR at a given desired signal level.

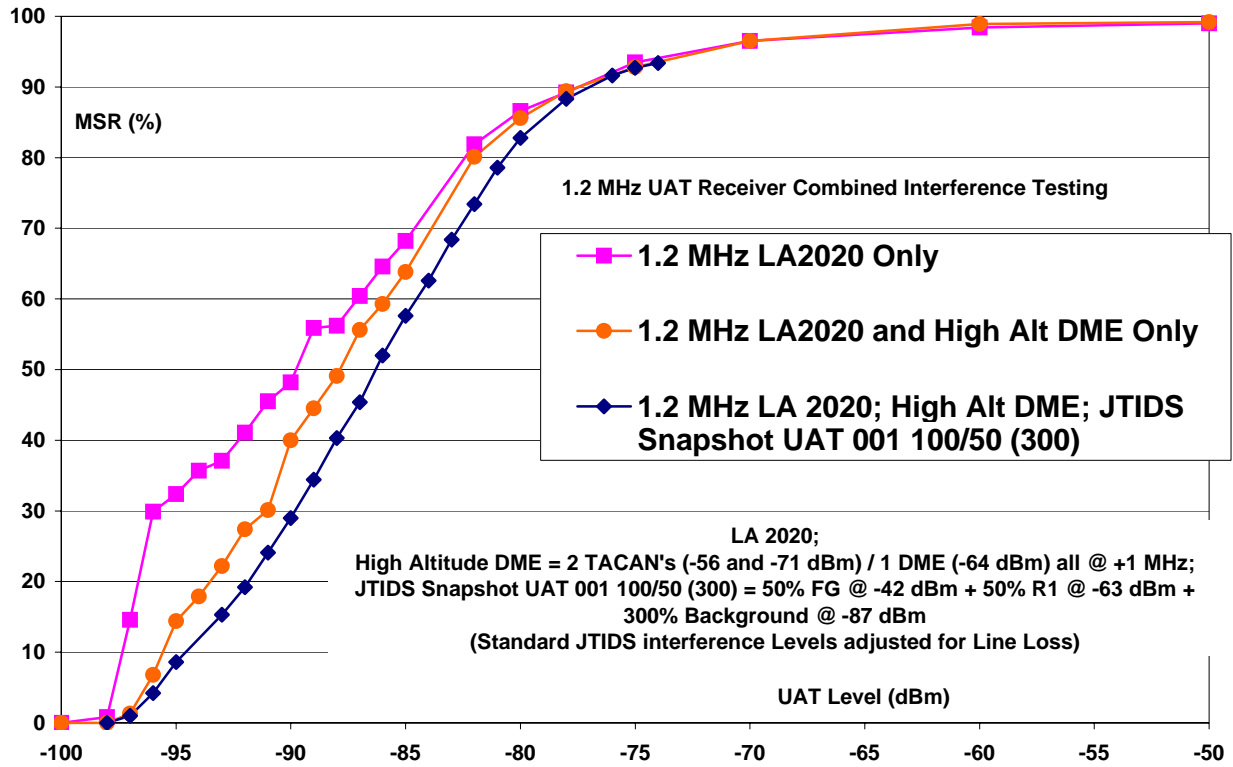

Figure B-47: Bench Test Measurements of UAT Performance in the LA2020 UAT Self-Interference, Combined with DME/TACAN and Link 16 Interference

This page intentionally left blank.

Appendix C

Standard Interference Environment

This page intentionally left blank.

C Standard Interference Environment

C.1 Background

The Universal Access Transceiver (UAT) is designed to operate in the lower portion of the 960-1215 MHz aeronautical radionavigation service (ARNS) band. This portion of the band is heavily utilized throughout the world for International Civil Aviation Organization (ICAO) standard systems such as Distance Measuring Equipment (DME), and military systems such as Tactical Air Navigation (TACAN), and in some countries the Joint Tactical Information Distribution System/Multifunctional Information Distribution Systems (JTIDS/MIDS). Each of these systems share a common characteristic in that they utilize pulses that are short in relation to UAT pulses. As a result, the UAT waveform and receiver front-end has been specifically tailored to tolerate a high-density pulsed environment. In addition, the random-start nature of the UAT ADS-B access protocol results in self-interference. The extent of this interference is dependent on the number of aircraft visible to the “victim” UAT.

Because of the complexity of the potential interference environment, UAT performance in an operational environment was determined through the use of high-fidelity computer simulations. Those simulations were based on two specific inputs:

1. The performance of the UAT receiver in the presence of interference¹ as a function of signal-to-interference and desired-to-undesired signal overlap; and
2. The time/amplitude distribution of interfering signals. This Appendix will address the assumptions driving the latter input, while the UAT test specifications (RTCA DO-282A, §2.4) will ensure that UAT equipment meeting the UAT MOPS (RTCA DO-282A) can match the assumed UAT performance.

C.2 Operational Environments

The operating frequency of UAT at 978 MHz was selected to minimize the impact to existing DME/TACAN use. That DME/TACAN channel (17X) is reserved worldwide for “emergency use,” and as a result there exist very few operational 978 MHz DME/TACAN systems. In the United States for example, both 978 MHz and 979 MHz are reserved for DME “ramp tester” equipment. Such an application is very low power, offering no interference to UAT usage². Europe however does use both 978 MHz and 979 MHz for operational DME/TACAN, so European scenarios considered DME/TACAN as an interference source. It should be noted that early test and analysis results indicated that, for off-board DME/TACAN, only those that were co-frequency and/or first adjacent-frequency to the UAT (i.e., on 978 or 979 MHz) need be considered. This accrued as a result of the narrow spectral content of the DME/TACAN signals, in concert with the good frequency rejection properties of the UAT receiver. While the UAT SARPs contain a rejection of pulsed interference requirement for 980 MHz DMEs as well as DMEs operating at frequencies above 980 MHz, the impact of this interference on overall UAT system performance is projected to be negligible.

¹ This performance was quantified through high-fidelity bench test measurements.

² Testing and analysis has also shown that co-frequency UAT usage will not interfere with ramp tester implementation.

Driven by the diverse environments in which UAT would operate, a number of different interference scenarios were postulated and simulated. The goal was to ensure that the UAT design would provide the necessary performance as UAT traffic increases in the future and to ensure that UAT receivers are measured against the most challenging interference environment from JTIDS/MIDS³ and DME sources. Within a given scenario, UAT receiver locations were chosen to represent the most challenging geographic areas.

Aircraft distributions were based on scenarios developed by the joint United States Federal Aviation Administration (FAA)/Eurocontrol Technical Link Assessment Team (TLAT) to assess candidate ADS-B links. One scenario was intended to represent a low-density air traffic environment, while another mimicked introducing UAT into today's Core Europe setting. The final two "future" scenarios predicted Los Angeles Basin 2020 and Core Europe 2015 environments respectively. Together these scenarios provided diverse assessments of UAT performance, and their characteristics are catalogued in Table C-2. Note that to fully assess the resulting performance of a victim UAT receiver, practical UAT receiver implementation limitations that impact receiver availability are also included.

To analyze DME interference in core Europe, the International Civil Aviation Organization (ICAO) database⁴ of existing and planned DME/TACAN assignments was examined. While the underlying assumption for DME/TACAN is that co-channel assignments will eventually need to be moved in order to achieve full operational UAT performance, it is also recognized that in the near-term low-density UAT self-interference environments offer performance margin that could be used to accommodate co-channel DME/TACAN interference. Geographic analysis of existing DME/TACAN assignments – i.e., quantifying the number and power of received DME/TACAN signals at geographic points in space – resulted in development of the environments shown in Table C-3 to capture current worst-case DME/TACAN conditions. In recognition of future environments, the UAT design was tailored to ensure that UAT could provide an adequate level of performance as 978 MHz DME/TACANs are reassigned over time. As part of this, noting that current "planned" assignments allow latitude for regulators to expand usage of 979 MHz, assumptions were made to predict future DME/TACAN interference. In particular, for the Core Europe 2015 scenario, it was assumed that while all 978 MHz DME/TACANs were reassigned, all planned 979 MHz assignments in ICAO database had become operational. Details of the resultant environments are captured in Table C-4. In total, the goal of each of the test scenarios was to reasonably over-bound any operational environment the UAT could be expected to experience.

Sample Derivation:

Figure C-1 illustrates a scenario in today's environment focusing on an aircraft at 40,000 feet flying over Germany. Using the DME/TACAN emitter location and power information from the ICAO database, the DME and TACAN normalized ground station antenna patterns shown in Figures C-2 and C-3, relative emitter-aircraft geometry, and

³ JTIDS/MIDS scenarios are defined in terms of source time slot duty factor (a measure of number of pulses per second), and source received power level. For the MOPS effort a number of operational JTIDS/MIDS scenarios were provided by the US Department of Defense as representing postulated training needs. These were included as part of the standard interference environment as shown in Table C-2.

⁴ Listings were reviewed/verified by Eurocontrol.

propagation loss equations, the values in Table C-1⁵ can be derived. Repeating for various locations/geometries allowed the worst-case positions to be determined and utilized for compatibility analyses.

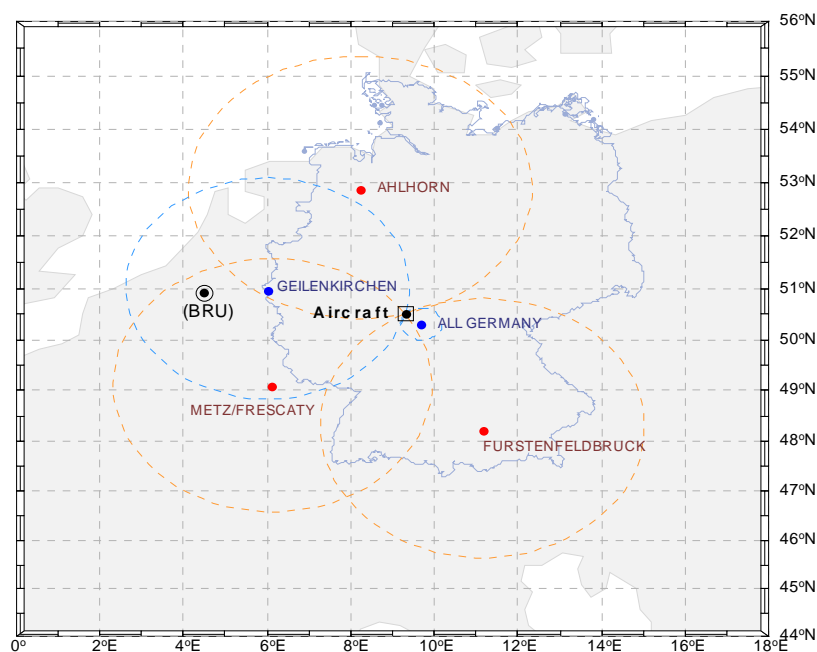

Figure C-1: Sample Scenario

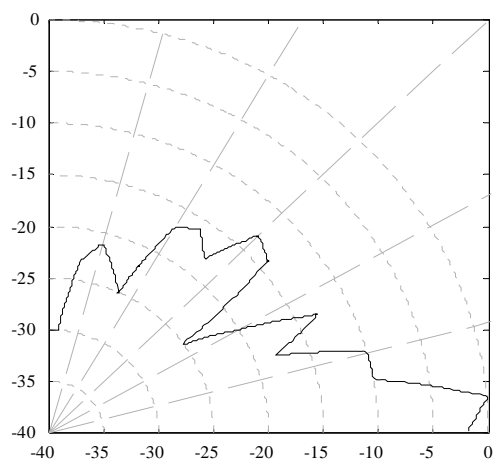

Figure C-2: Normalized DME Pattern

⁵ Note these levels are also reflected in row 4 of Table C-3. The “All Germany” emitter reflects a mobile TACAN. For the purpose of this assessment it was placed in the worst-case location allowed by channel assignment rules.

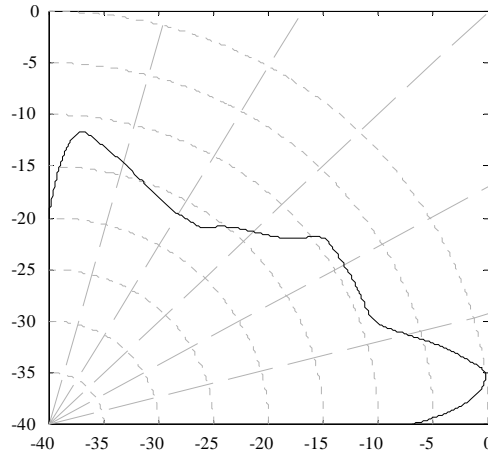

Figure C-3: Normalized TACAN Pattern

Table C-1: Signal Level Analysis of the Sample Scenario

	AHLHORN	FURSTENF...	METZ/FRE...	GEILENKI...	ALL_GERM...
Type	TAC	TAC	TAC	TAC	Mobile TAC
Longitude (deg)	8.233	11.150	6.133	6.017	9.298
Latitude (deg)	52.883	48.217	49.067	50.967	50.525
Frequency (MHz)	978	978	978	979	979
Ground Distance (NM)	148.7	155.2	150.1	128.0	1.5
Elevation Angle (deg)	2.54	2.43	2.51	2.94	77.13
EIRP (dBm)	70	70	70	67	70
Normalized Ground Antenna Gain (dB)	-2.67	-2.81	-2.71	-2.19	-13.25
Free-Space Propagation Loss (dB)	-141.05	-141.42	-141.14	-139.77	-114.19
Rec. Power at Aircraft Antenna (dBm)	-73.72	-74.23	-73.85	-74.96	-57.44

C.3 Co-Site Environment

In addition to all the scenarios for the external interference environment, effects were included to account for on-board sources of interference from co-aircraft L-Band systems. The components of this co-site environment were estimated during the TLAT deliberations and have been further refined for the expected UAT aircraft installations. This environment was selected to be conservative and consistent for all aircraft classes, which resulted in including, for example, the assumption that A0 aircraft could be equipped with airborne collision avoidance systems (ACAS). The co-site environment is defined in Table C-5, depicting the assumptions of transmission duration and rates of onboard L-Band transmitters, including signals from onboard DME equipment, TCAS and transponders. Also noted is the allowance made for receiver recovery time under the assumption that pulse suppression circuitry is employed.

C.4 Scenario Assessments

With the preceding environments established, ADS-B reception performance was assessed for various receiver types in various locations within the environment⁶. The primary metric was the update interval achieved at a 95% confidence level for 95% of the aircraft population of interest. In early assessments of air-air surveillance performance, the aircraft population of interest was limited in elevation relative to the own aircraft in order to eliminate from consideration targets that were of no operational interest (see Figure C-4). However, this limitation of the aircraft population of interest was not used in the performance assessment reported in the UAT MOPS, RTCA DO-282A, Appendix K because an alternate method of using “probes” was employed as described in that Appendix.

Table C-6 is a matrix delineating the individual simulations performed in making design decisions for the UAT MOPS, RTCA DO-282A. Results from a select subset of these simulation runs are provided in Appendix B to indicate performance that can be expected of a UAT built to the standards of the UAT MOPS, RTCA DO-282A.

⁶ It is recognized that UAT ground stations in close geographic proximity to 978 or 979 MHz DME/TACAN transponders may require special siting to ensure proper operation of the UAT equipment.

Table C-2: Interference Scenarios and Implementation Assumptions

		Scenarios			
		Core Europe 2015	Core Europe Current	LA 2020	Low Density
Standard Interference Environment	UAT Self Interference	Per TLAT Core Europe 2015 (2091 a/c in 300 NM radius) + 100 Surface vehicles per major airport @ 28-32 dBm and 1 Basic msg/sec	1193 aircraft 500 ground vehicles 300 NM radius	Per TLAT LA 2020 (2694 a/c in 400 NM radius) + 100 Surface vehicles per major airport @ 28-32 dBm and 1 Basic msg/sec	Per TLAT Low Density (360 a/c in 400 NM radius) + No surface vehicles
	DME	All currently planned 979 assignments See Table C-4	All current 978 MHz and 979 MHz assignments See Table C-3	None	Same DME environment as CE 2015
	JTIDS (levels seen at UAT victim antenna port)	TSDf 50% @ -39 dBm + TSDf 50% @ -60 dBm + TSDf 300% @ -84.5 dBm	TSDf 50% @ -39 dBm + TSDf 50% @ -60 dBm + TSDf 300% @ -84.5 dBm	TSDf 50% @ -39 dBm + TSDf 50% @ -60 dBm + TSDf 300% @ -84.5 dBm	TSDf 50% @ -39 dBm + TSDf 50% @ -60 dBm + TSDf 150% @ -78 dBm + TSDf 150% @ -82 dBm
Installation and Implementation Assumptions	Co-site	See Table C-5 (scenario independent)			
	UAT Implementation Effects (Applies to all classes)	Re-trigger capable			
		T/R switching results in 2 millisecond receiver blanking immediately before and after own-ship transmissions			
		-20 dBc pedestal for 4 usec duration immediately before and after own-ship transmission			
		“Pulse stretching” effects from high level DME seen in bench tests of “Pre-MOPS” units included in model			

Table C-3: Received Power Levels (dBm) for Current European DME/TACAN Environment

Aircraft (Lat, Lon)	Alt (ft)	AHLHORN	METZ/FRE...	FURSTENF...	ALL_GERM...	BRUGGEN	GEILENKI...
50.9 deg, 4.5 deg	40000	-76	-72		-79	Not Operational	-66
50.9 deg, 4.5 deg	15000		-75				-69
50.5 deg, 9.3 deg	40000	-74	-74	-74	-57		-75
50.5 deg, 9.3 deg	15000	-76	-76	-77	-53		-78

Table C-4: Received Power Levels (dBm) for 2015 European DME/TACAN Environment

Aircraft (Lat, Lon)	Alt (ft)	AHLHORN	METZ/FRE...	FURSTENF...	ALL_GERM...	BRUGGEN	GEILENKI...
50.9 deg, 4.5 deg	40000	Assumed Cleared			-77	-76	-66
50.9 deg, 4.5 deg	15000				-68	-76	-69
51.0 deg, 6.0 deg	40000				-70	-76	-62
51.0 deg, 6.0 deg	15000				-72	-72	-56

Table C-5: Co-site Environment

Event	Event Blanking Interval (usec)		Events per Second			
	Event Duration	Additional Blanking due to Rx Recovery	A0	A1 (L)/(H)	A2	A3
DME Interrogations	19	15 μsec	70	70	70	70
ATCRBS Replies	20	15 μsec	200	200	200	200
Mode S Replies	64	15 μsec	4.5	4.5	4.5	4.5
Mode S Interrogations	20	15 μsec	5	5	5	5
Whisper Shout Interrogations	25	15 μsec	80	80	80	80

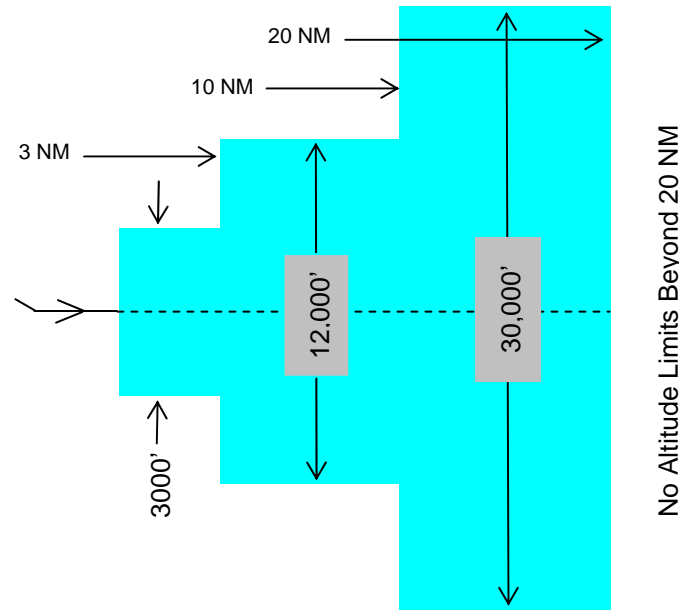

Figure C-4: Targets of Interest for Computing Update Interval

Table C-6: Overview of Scenario Assessments

Perspective of Victim Receiver			Scenario			
Location	Altitude	Rx Type	Core Europe 2015	Core Europe Current	LA 2020	Low Density
At Scenario Center	40,000'	A3	x	x	x	x
		A2	x	x	x	
		A1	x (H)	x(H)	x (H)	
	15,000'	A2/A3	x	x	x	
		A1	x	x	x	
		A0	x	x	x	
	On Approach (2000')	A0-A3 ⁷	x	x	x	
	On Surface (979 MHz DME @ -10 dBm)	A0 ⁸	x		x ⁹	
		Ground Station	x		x ¹⁰	
Ground Station ¹¹		x				
At Worst Case DME	40,000'	A3	x	x		x
		A2	x	x		
		A1	x(H)	x(H)		
	15,000'	A2/A3	x	x		
		A1	x	x		
		A0	x	x		

⁷ Update intervals based on aircraft “probe” approaching from 20 miles

⁸ Update intervals based on aircraft “probe” approaching from 20 miles at 2000'

⁹ No DME interference included in this case

¹⁰ No DME interference included in this case

¹¹ With cavity filter in line that is assumed to reduce DME interference to that equivalent of on-channel DME at -50 dBm. Filter assumed to introduce insertion loss of 4 dB

This page intentionally left blank.

Appendix D

UAT Receiver Performance in the Presence of JTIDS/MIDS, DME/TACAN and Self-Interference

This page intentionally left blank.

D. UAT Receiver Performance in the Presence of JTIDS/MIDS, DME/TACAN and Self-Interference

D.1 Introduction

Tests were conducted during the early standards work of UAT to insure that the UAT system provides acceptable performance in the intended future worst-case environments. Results of testing with the Standard Interference Environment described in Appendix C are summarized in Appendix B. Extensive testing was conducted on prototype UAT receivers and additional testing was conducted on production-level equipment to characterize UAT receiver performance and validate acceptable performance of equipment that is designed to the developed standards. As described in Appendix C, sources of interference to the UAT receiver include on-channel self- interference from other UAT transmitters, DME on-channel or adjacent channel and JTIDS/MIDS signals that periodically occupy the frequency band at or near the 978 MHz UAT center frequency. The following test results contain data that was collected to assess UAT receiver performance against each interference source individually and in combination.

D.2 Pre-Production Testing

Testing was conducted during the development of the RTCA UAT MOPS (RTCA/DO-282A) to characterize UAT receiver performance when subjected to signals from systems that could impact UAT receiver performance. Testing also served to insure that receiver requirements specified resulted in expected performance. Pre-production units (which will be referred to as “Pre-MOPS” units) were produced and used as victim receivers subjected to various interference scenarios to characterize and validate performance. Pre-MOPS receivers tested included both the Standard Receiver and the High performance receiver. For the purposes of the data presented in this section, the Standard Receiver is referred to as the 1.2 MHz receiver and the High Performance receiver is the 0.8 MHz receiver denoting the receiver filter bandwidths of each Pre-MOPS receiver type.

D.2.1 DME/TACAN Testing

Testing was conducted subjecting the Pre-MOPS receivers to various DME and TACAN signal powers and rates to assess impact. DME frequencies were selected to assess impact of on-channel DME interference, 1 MHz adjacent channel and 2 MHz off channel DME signals. In each of the series of test runs, a desired UAT signal was subjected to the TACAN or DME interference where the desired signal level was varied, typically in 1 dB steps, from below receiver sensitivity to above a power level where receiver performance was no longer impacted by the interference source.

The following data presents results from subjecting the UAT receiver with DME pulse pairs at various rates and amplitudes. The results of receiver performance with DME at 2700 pulse pairs per second 2 MHz from the UAT frequency are contained in Figure D-3. Power levels of the DME interference injected were -15, -21, -27 and -34 dBm. The results indicate that the Standard Receiver provides slightly better performance to DME signals 2 MHz above the UAT frequency.

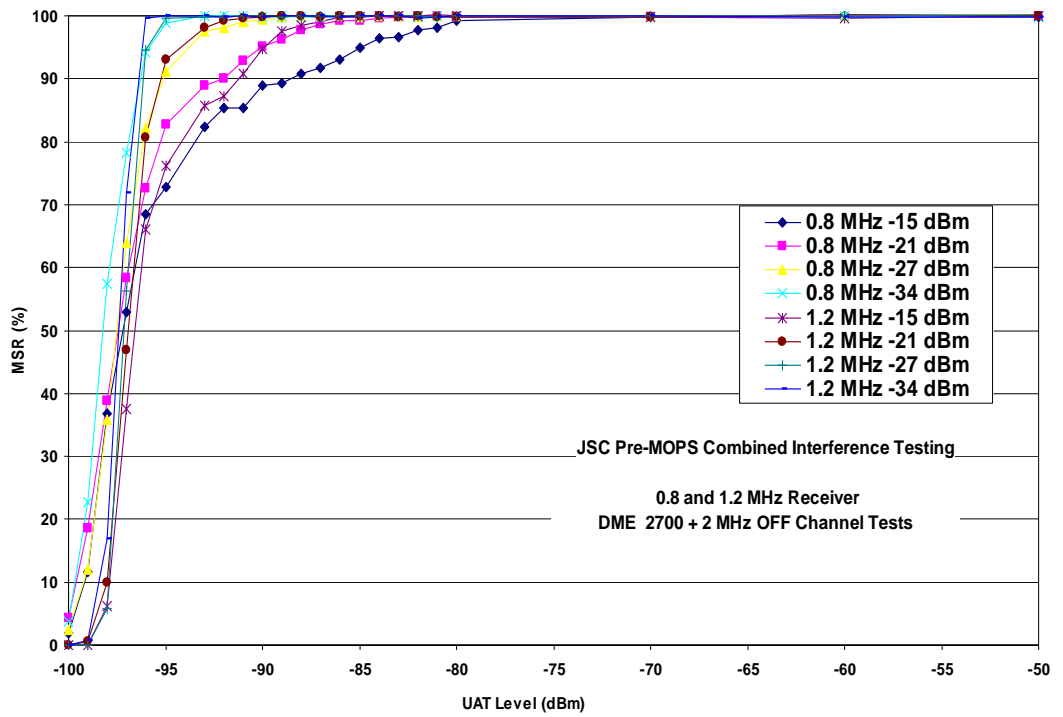

Figure D-3: UAT Receiver Performance DME 2700 Pulse Pairs at +2 MHz

Figure D-4 and Figure D-5 contain results from subjecting the Standard Receiver and the High Performance receiver, respectively, to DME at 2700 pulse pairs per second 1 MHz above the UAT frequency at various amplitudes.

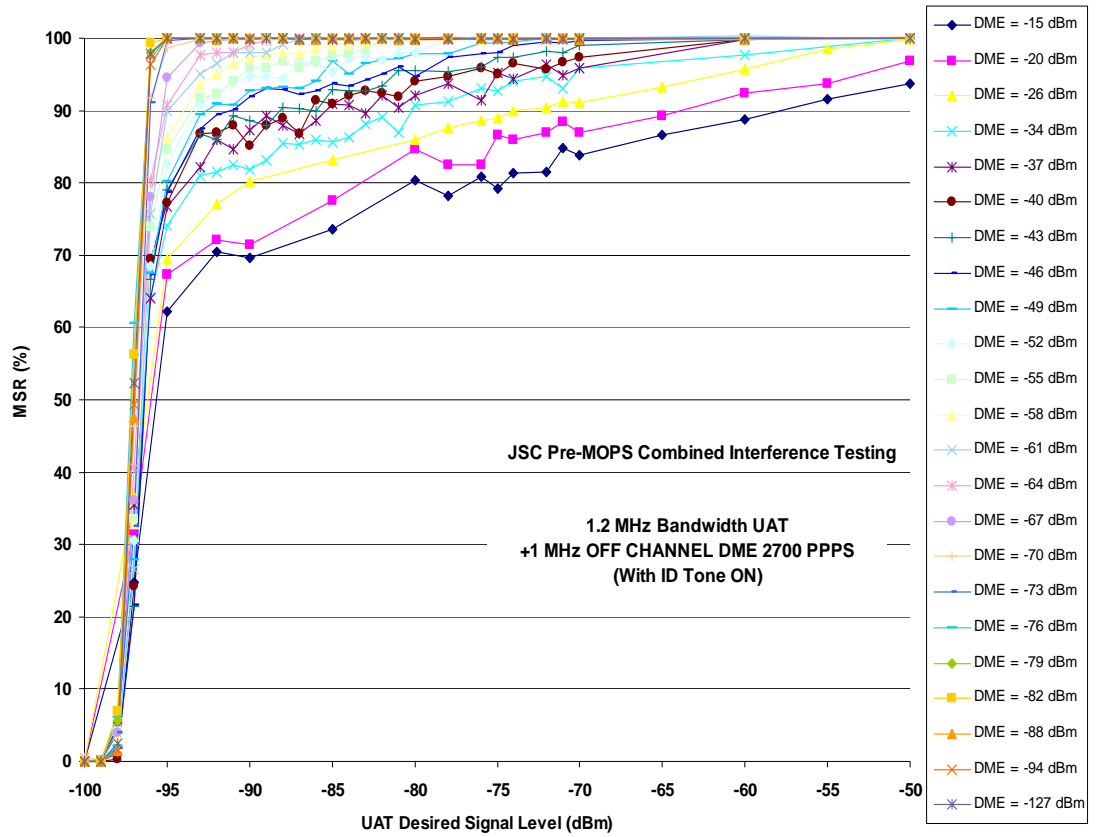

Figure D-4: UAT Standard Receiver Performance DME 2700 Pulse Pairs at +1 MHz

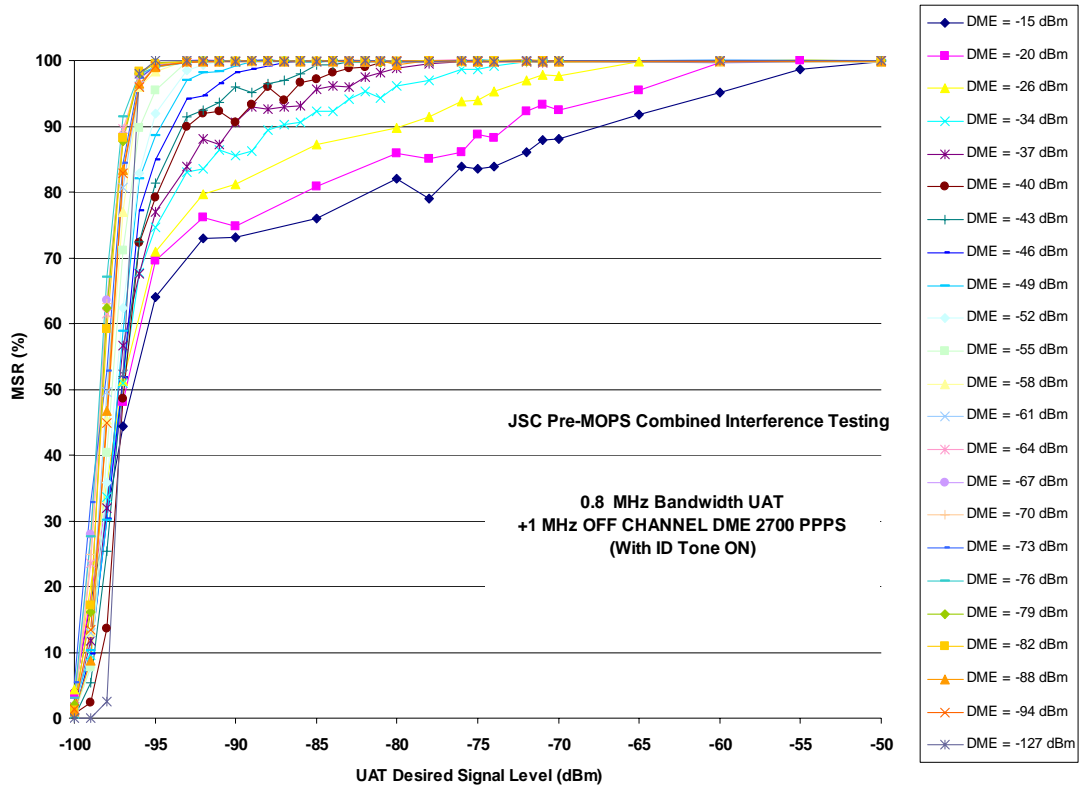

Figure D-5: UAT High Performance Receiver with DME 2700 Pulse Pairs at +1 MHz

Figure D-6 and Figure D-7 contain results from subjecting the Standard Receiver and the High Performance receiver, respectively, to DME at 2700 pulse pairs per second on the UAT frequency at various amplitudes. Figure D-8 through Figure D-14 contain similar results except that the DME pulse pairs were injected at the higher 3600 pulse pairs per second rate. Figure D-15 shows a comparison between TACAN and DME interference to both the Basic and High Performance UAT receivers. A simulated DME station at 3600 pulse pairs per second (DME signals are normally not transmitted at this rate) is compared to TACAN at 2700. The power level of -60 dBm was applied to the UAT receiver at a frequency offset of 1 MHz from the UAT operating frequency. Figure D-15 shows comparable performance between TACAN and DME interference at the same amplitude; the number of pulses pairs is the dominant performance consideration. Comparison of UAT Basic and High Performance receivers indicates improved performance with the High Performance receiver when subjected to DME/TACAN pulse pairs that are 1 MHz offset from UAT.

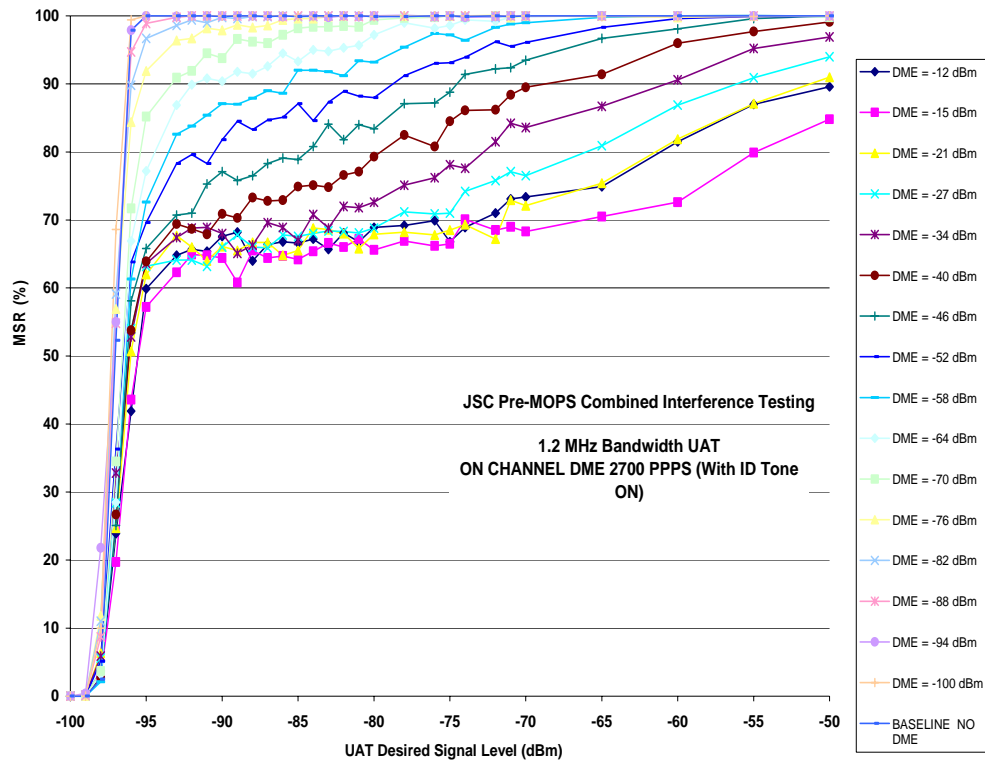

Figure D-6: UAT Standard Receiver Performance DME 2700 Pulse Pairs On Frequency

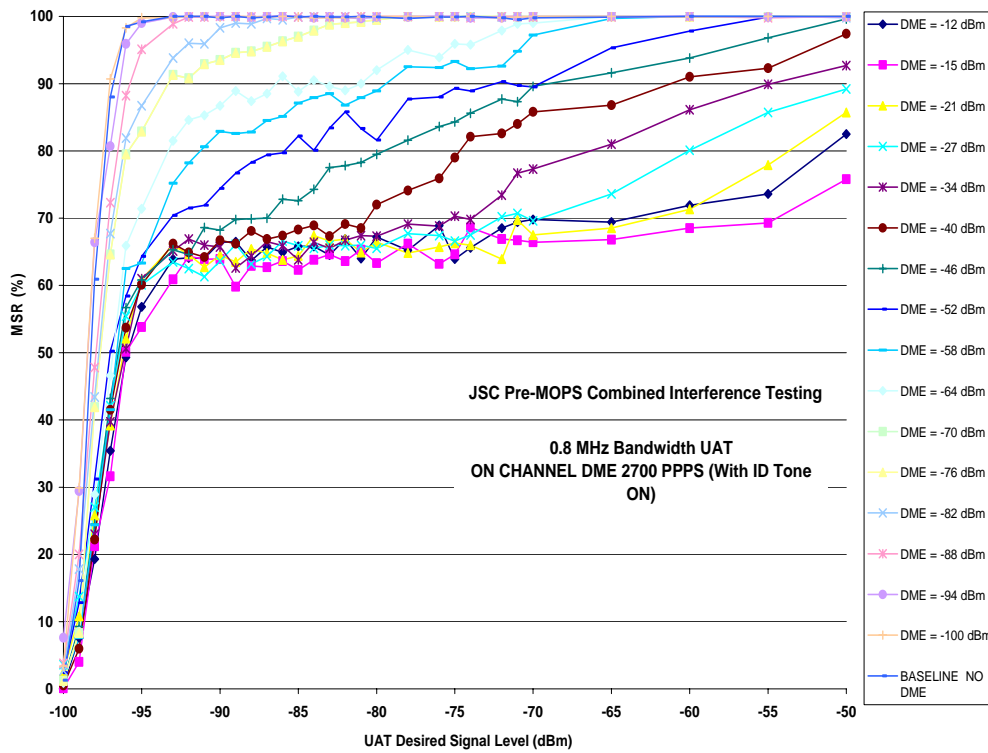

Figure D-7: UAT High Performance Receiver DME 2700 Pulse Pairs on Frequency

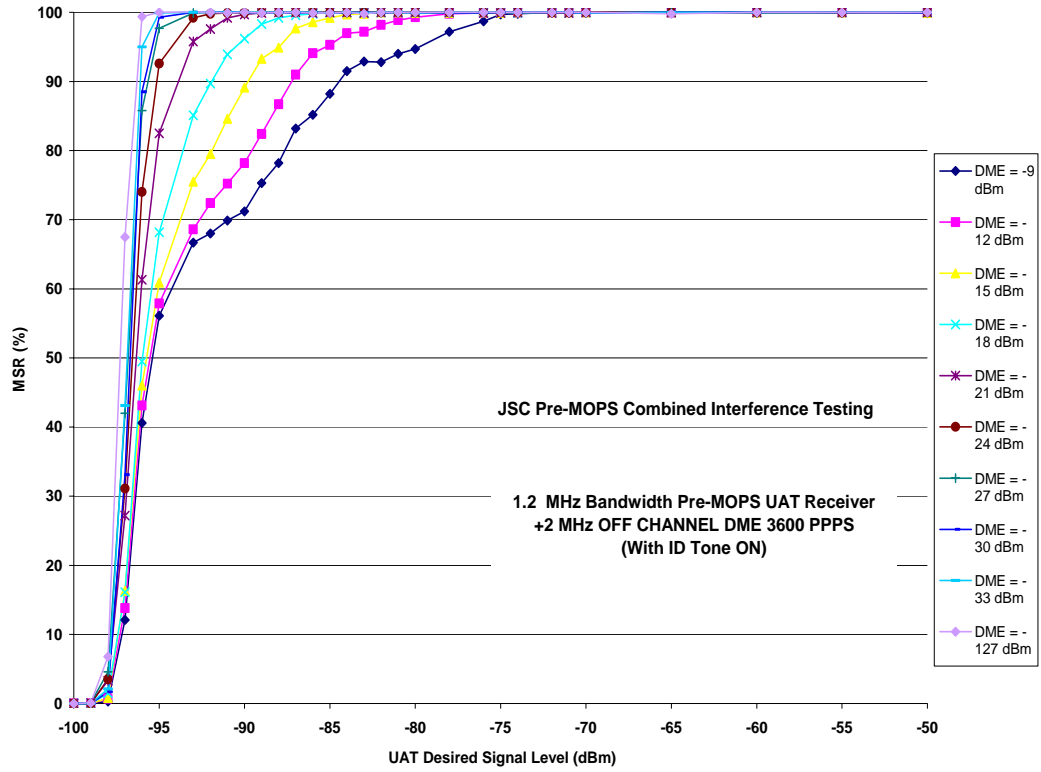

Figure D-8: UAT Standard Receiver Performance DME 3600 Pulse Pairs at +2 MHz

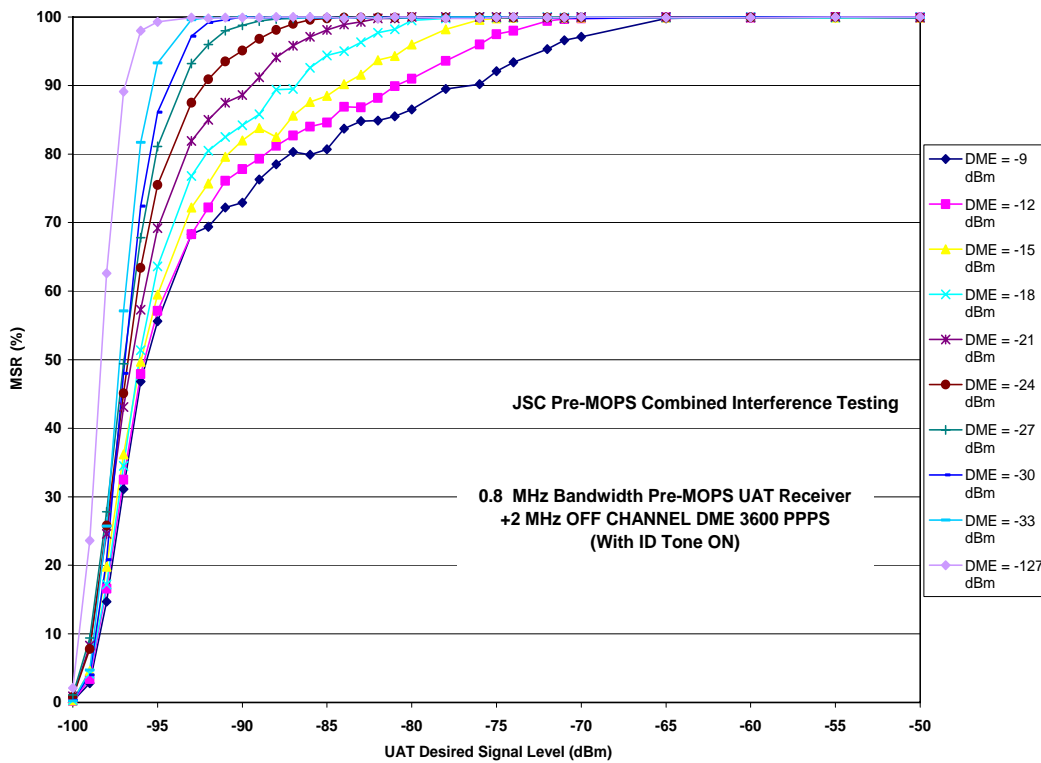

Figure D-9: UAT High Performance Receiver DME 3600 Pulse Pairs at +2 MHz

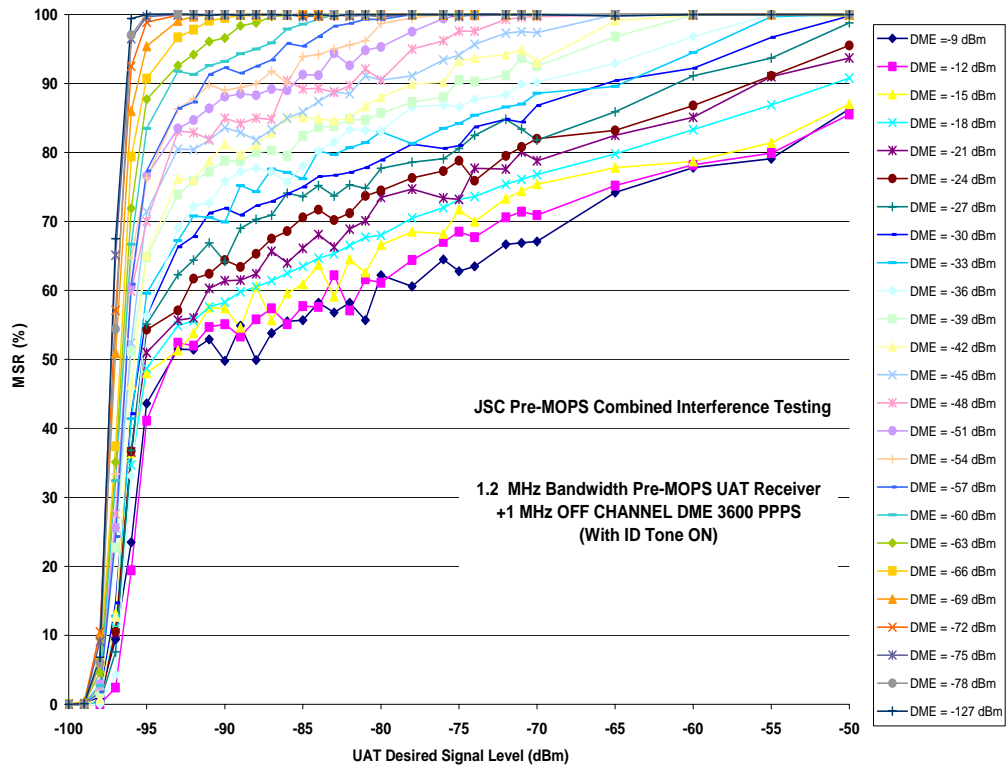

Figure D-10: UAT Standard Receiver Performance DME 3600 Pulse Pairs at +1 MHz

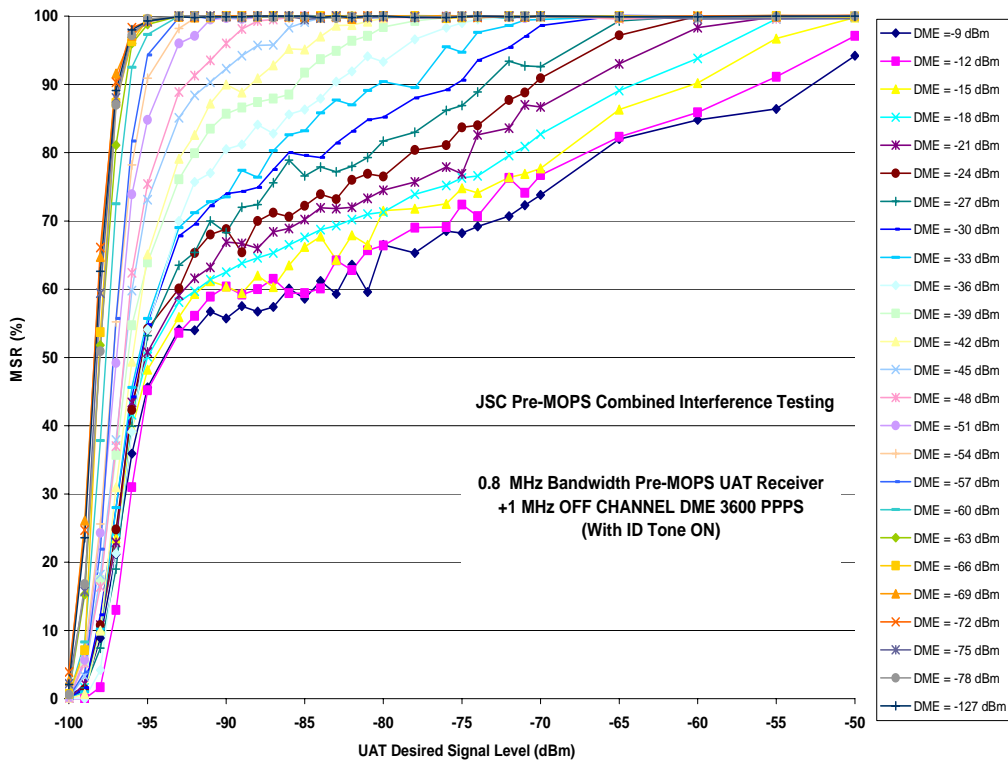

Figure D-11: UAT High Performance Receiver DME 3600 Pulse Pairs at +1 MHz

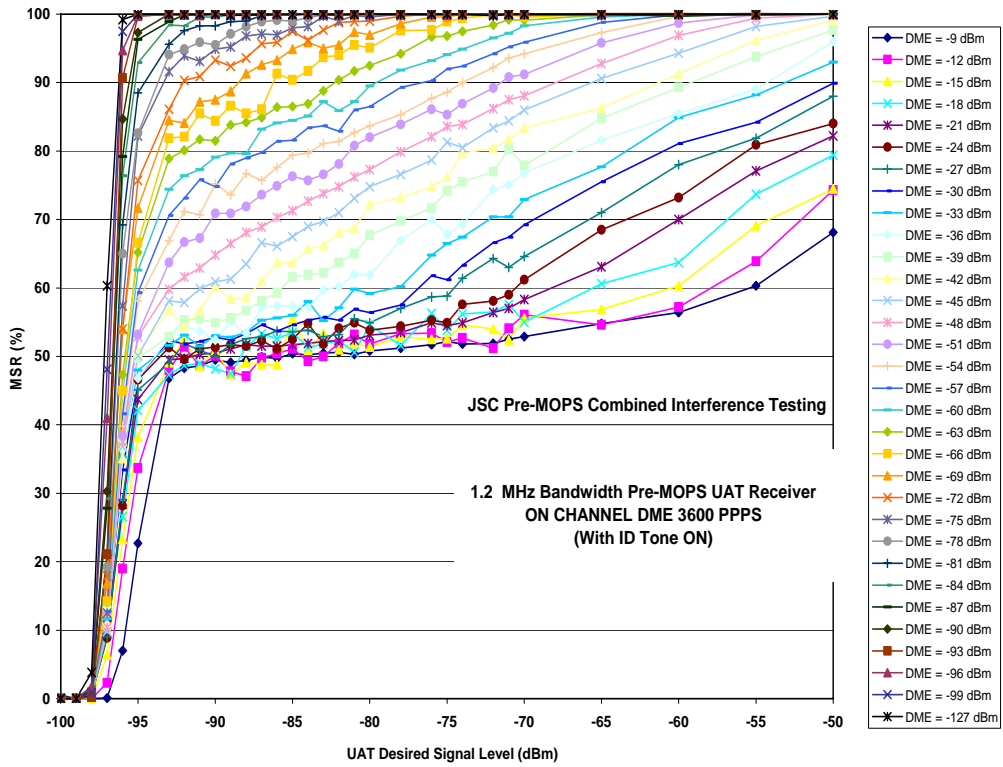

Figure D-12: UAT Standard Receiver Performance DME 3600 Pulse Pairs On Frequency

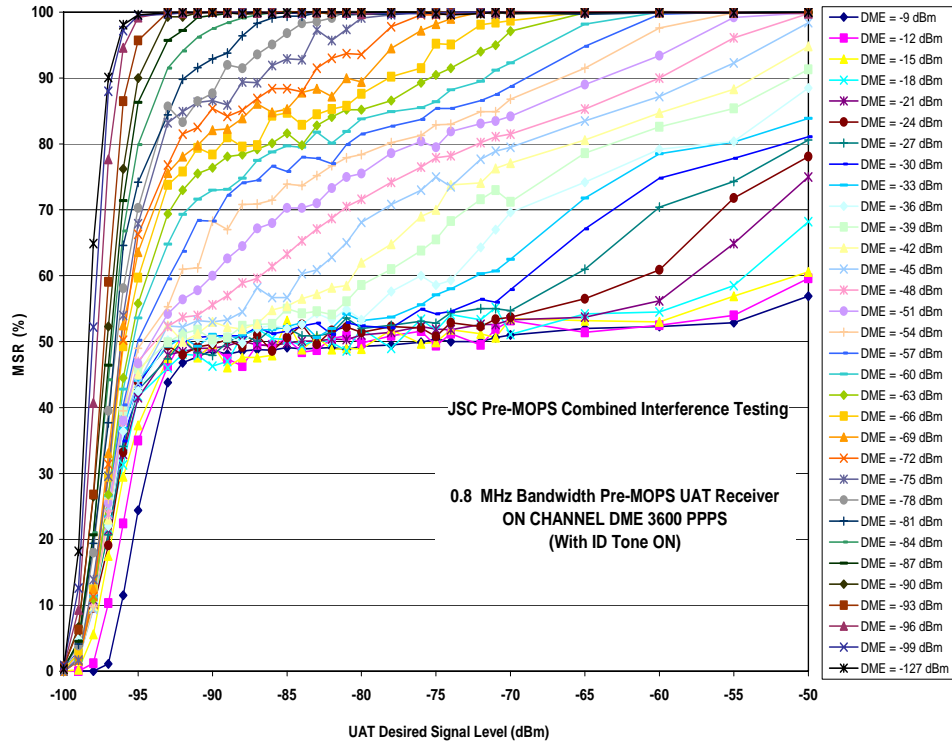

Figure D-13: UAT High Performance Receiver DME 3600 Pulse Pairs on Frequency

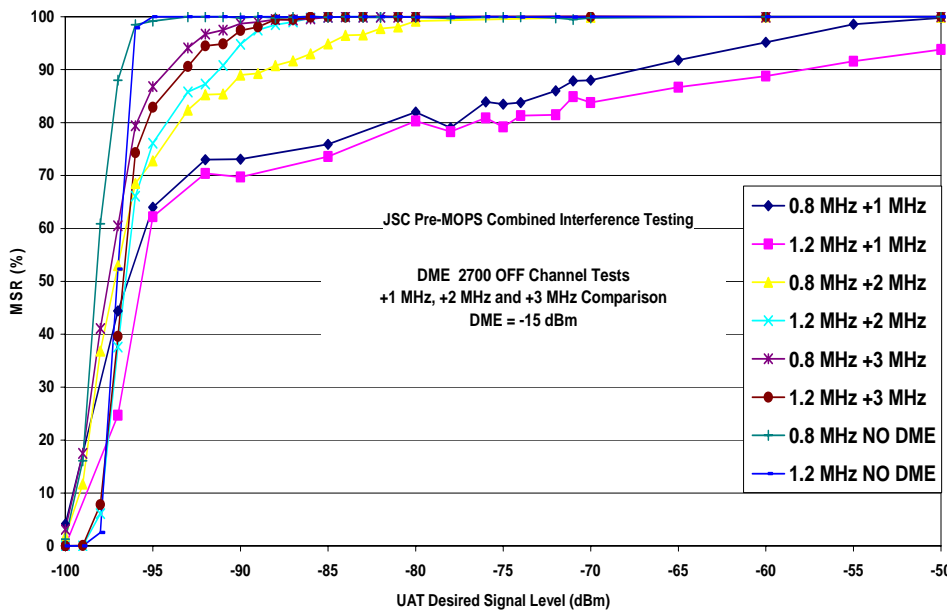

Figure D-14: UAT Receiver Performance DME 2700 Pulse Pairs Offset in Frequency

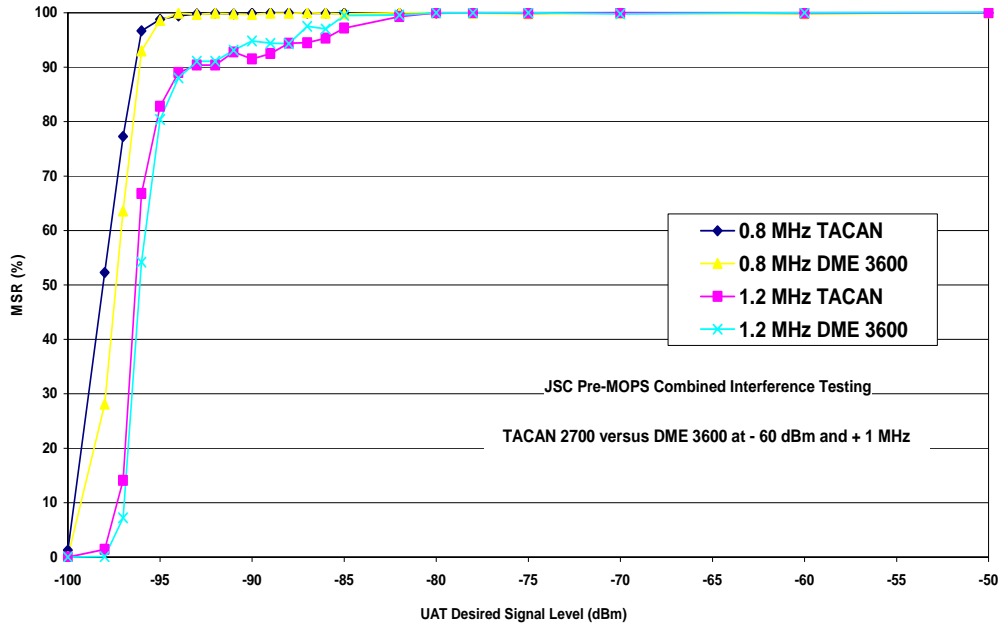

Figure D-15: UAT Receiver Performance TACAN 2700 and DME 3600 Pulse Pairs at +1 MHz

D.2.2 JTIDS/MIDS Testing

Testing was conducted subjecting the prototype receivers to various JTIDS/MIDS scenarios. These scenarios were derived and utilized in development of the Standard Interference Environment as described in Appendix C.

Two scenarios were developed and used to test UAT performance against JTIDS/MIDS. A first scenario, depicted in the first three columns of Table C-2, is a scenario that was utilized in all prior JTIDS and DME compatibility testing. A second scenario, depicted in the fourth column of Table C-2, consisted of a denser JTIDS environment. Both scenarios represented multiple JTIDS signal levels with one or more users and allocated JTIDS pulses into groups each with an assigned duty factor and amplitude level. JTIDS transmissions occur in time slots that are assigned randomly by the transmitter, so the scenarios were defined by the percentage occupation of legal time slots. The strongest amplitudes are the foreground transmissions followed by up to 4 rings, each with decreasing power level. Each ring is assigned a time slot duty factor (TSDF). The first scenario consisted of a 300% JTIDS background density.

Figure D-16 shows the performance of the UAT receiver as a function of desired signal level when subjected to the first JTIDS/MIDS scenario. Both the Standard Receiver and the High Performance receiver results are depicted. In general, the entire set of JTIDS/MIDS scenario runs yielded similar results as to impact to UAT receiver performance.

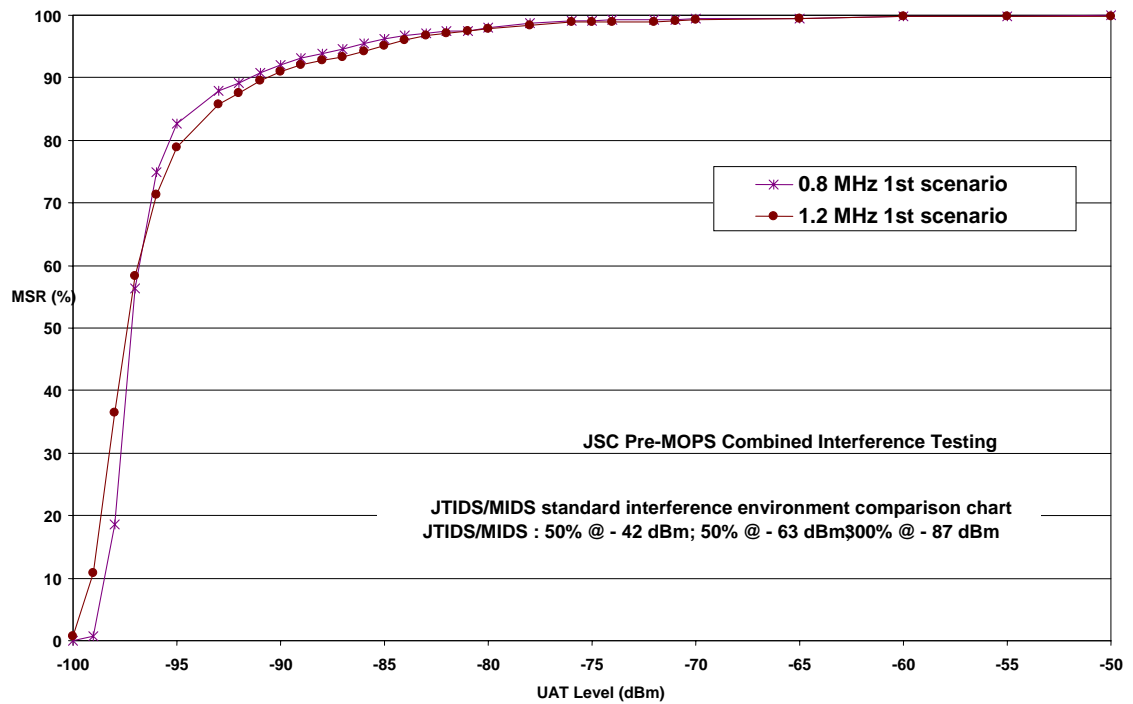

Figure D-16: UAT Receiver Performance with the first JTIDS/MIDS Scenario

D.2.3 UAT Self-Interference Testing

UAT self-interference testing was conducted under the future high density Core Europe 2015 and LA 2020 scenarios described in Appendix C. Results of self-interference testing with the Pre-MOPS units are shown in Appendix B.

D.2.4 Combined Interference Testing

UAT combined interference testing, including the effects of self-interference, TACAN/DME and JTIDS/MIDS was conducted under the future high density Core Europe 2015 and LA 2020 scenarios described in Appendix C. Results of combined interference testing with the Pre-MOPS units are shown in Appendix B.

D.3 Production Testing

Testing was conducted on production UAT airborne avionics since units produced under United States Federal Aviation Administration (FAA) Technical Standard Order (TSO) C154, that to conform to the UAT MOPS, RTCA/DO-282A, became available during the UAT SARPs Validation Phase. These units, the Garmin UAT Model GDL90, were certified as A1H type Airborne Transceivers. These units were bench tested to verify requirements related to interference rejection including self-interference and DME/TACAN. Since these units were tested according to the test procedures stipulated

in the RTCA UAT MOPS, DO-282A, TSO test results related to DME interference rejection were used to demonstrate compliance to the UAT SARPs.

Also, the receiver was subjected to future high density self-interference scenarios equivalent to those used to validate the Pre-MOPS receiver units used during the development of the UAT MOPS. Therefore, comparison of the future high density scenarios test results from tests that were conducted on the Pre-MOPS 1.2 MHz filter, the equivalent to the A1H Standard Receiver, can be made to validate that the requirements of the UAT SARPs. It would be expected that the production A1H Standard Receiver would result in acceptable performance when subjected to the future scenarios in which the UAT system will be operating. The self-interference performance measured on the production units would be expected to meet or exceed the performance of the Pre-MOPS units. These test results are described in the following subsections.

Although a certified production A3 transceiver was not available for production testing, production A1H units were modified with a narrow filter to conform to the receiver selectivity requirements of the A3 High Performance Receiver. Although the unit was not modified to conform to neither the A3 transmitter requirements nor the antenna diversity requirements, it served as a testable unit that could validate A3 receiver performance. Results of testing with these units are described below.

D.3.1 DME/TACAN Testing

Testing was conducted subjecting the Production Standard Receiver to the DME/TACAN pulsed interference requirements stipulated in the SARPs. DME interference on frequency at 978 MHz, first adjacent channel at 979 MHz and second adjacent channel at 980 MHz frequencies were selected to assess impact of on-channel DME interference, 1 MHz adjacent channel and 2 MHz off channel DME signals.

D.3.2 UAT Self-Interference Testing

UAT self-interference testing was conducted under the future high density Core Europe 2015 scenario, the identical scenario used in the Pre-Production testing described in section D.2.2. Results of self-interference testing with the A1H production units are plotted in Figure D-17. The plot includes the data from the Standard Receiver equivalent, the Pre-MOPS 1.2 MHz receiver filter, to verify that the certified A1H receiver meets or exceeds the performance achieved from the Pre-MOPS units. As shown in Figure D-17, performance of the A1H production unit comfortably exceeded the performance of the Pre-MOPS unit.

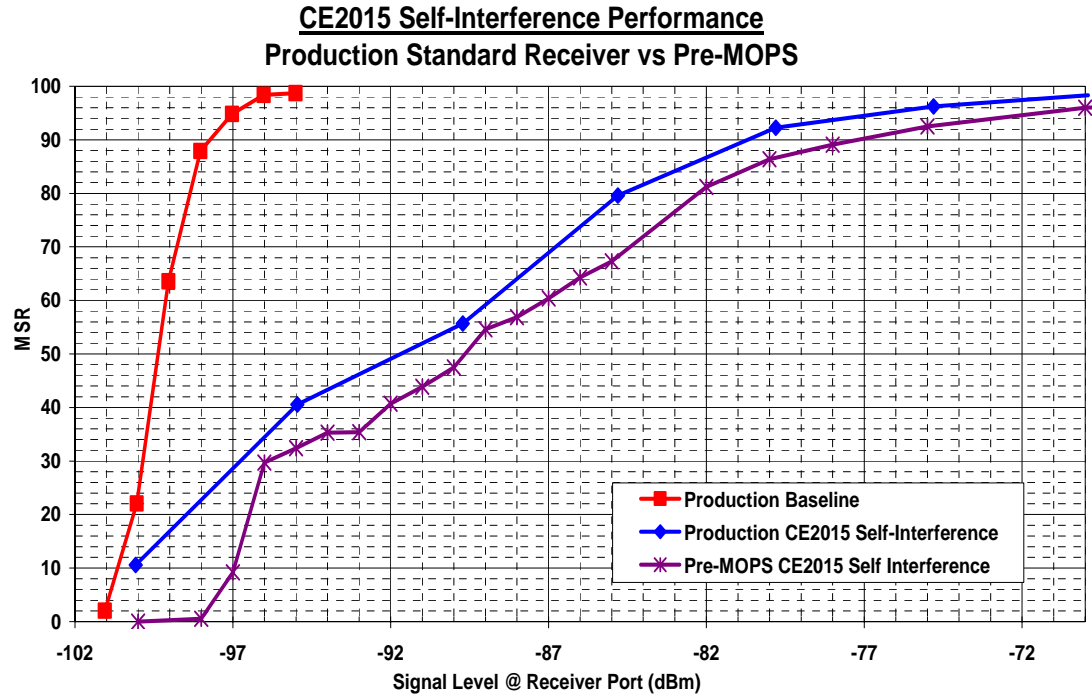

Figure D-17: UAT Production Standard Receiver Performance Comparison with the Core Europe 2015 Self-Interference Scenario

Results of self-interference testing with the UAT SARPs A3 receiver, the certified production A1H receiver unit modified with the A3 High Performance receiver filter characteristics, are plotted in Figure D-18. The plot includes the data from the High Performance Receiver equivalent, the Pre-MOPS 0.8 MHz receiver filter, to verify that a UAT receiver meets or exceeds the performance achieved from the Pre-MOPS units. As shown in Figure D-18, performance of the A3 unit comfortably exceeded the performance of the Pre-MOPS unit.

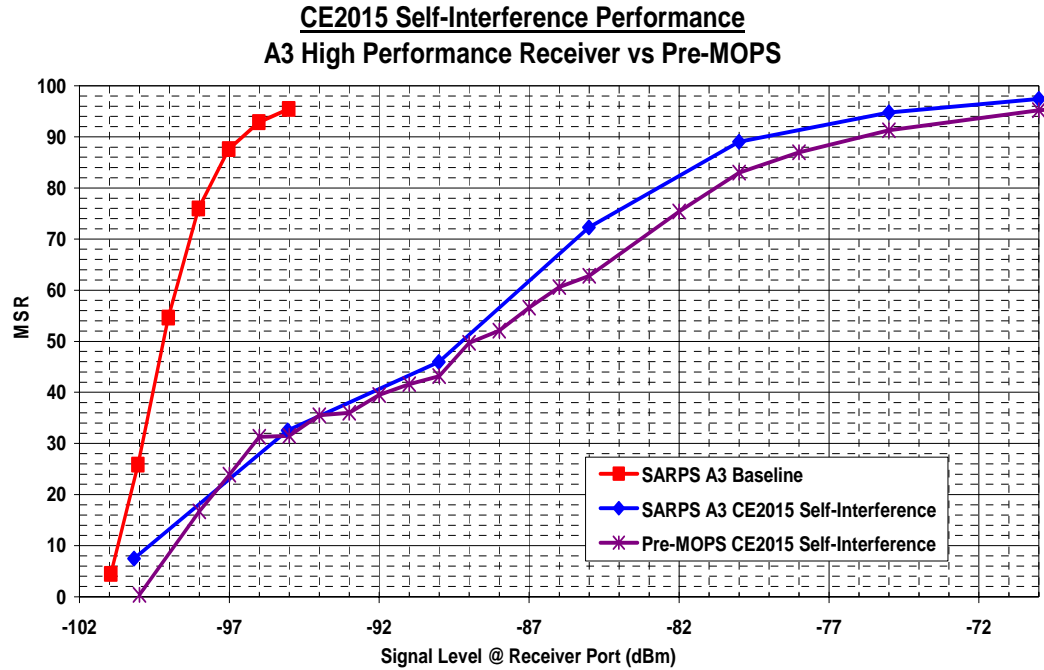

Figure D-18: UAT A3 Receiver Performance Comparison with the Core Europe 2015 Self-Interference Scenario

D.4 Summary

The results of bench tests conducted with prototype Basic and High Performance UAT Receivers with the interference sources that UAT will be subjected to verify that acceptable performance was achieved by the receiver design developed from the Pre-MOPS testing. These characteristics, when implemented, as shown by the results of testing of the certified production A1H Standard Receiver, verifies that when implementing the UAT SARPs requirements, acceptable performance is achieved.

Appendix E

UAT Error Detection and Correction Performance

This page intentionally left blank.

E UAT Error Detection and Correction Performance

This Appendix provides information on the performance of the Reed Solomon (RS) codes used by the various message types of UAT. The basic ADS-B Message is a RS (30, 18) code word; the long ADS-B Message is a RS (48,34) code word; and the ground up link message is six RS (92, 72) code words. These codes provide very strong error correction. Also, the error detection provided by these codes is sufficient to provide a maximum undetected error rate that is less than 10^{-8} for each of the message types, so additional CRC coding is not needed. Note that this excellent undetected error performance is due, in part, to the use of hard decision decoding. Schemes involving erasures might have considerably larger (i.e., degraded) undetected error rates.

The total word error rate for a RS (n, k) code is given by the formula:

$$P_E = \sum_{j=t+1}^n \frac{n!}{j!(n-j)!} p_s^j (1-p_s)^{n-j},$$

where $t=(n-k)/2$ and p_s is the symbol error rate (SER). P_E includes both undetected and detected word error probabilities. Because there are 8 bits per symbol, the connection between the SER and the channel bit error rate (BER) is given by:

$$p_s = 1 - (1 - p)^8.$$

where p is the channel BER.

The asymptotic value for the undetected word error rate (achieved when the channel bit error rate is 0.5) for a RS (n, k) code can be calculated using the formula:

$$P_U = \frac{256^k - 1}{256^n} \sum_{j=0}^t \frac{n!}{j!(n-j)!} 255^j$$

where $t=(n-k)/2$. The results are given in Table E-1.

Table E-1: Maximum Undetected RS Word Error Rates

Code	Maximum Undetected Word Error Rate
RS(30,18)	2.06e-9
RS(48,34)	9.95e-10
RS(92,72)	5.74e-12

The undetected error performance of a RS code as a function of channel bit error rate can also be calculated, but the mathematical complexity is much greater [1]. The results are shown in Figure E-1 through Figure E-3. These graphs show total word error rate together with undetected word error rate. The detected word error rate, P_D , is just the difference between the two curves. If the correct word error rate is defined as P_C , then all the probabilities are related by:

$$1 = P_E + P_C = P_U + P_D + P_C.$$

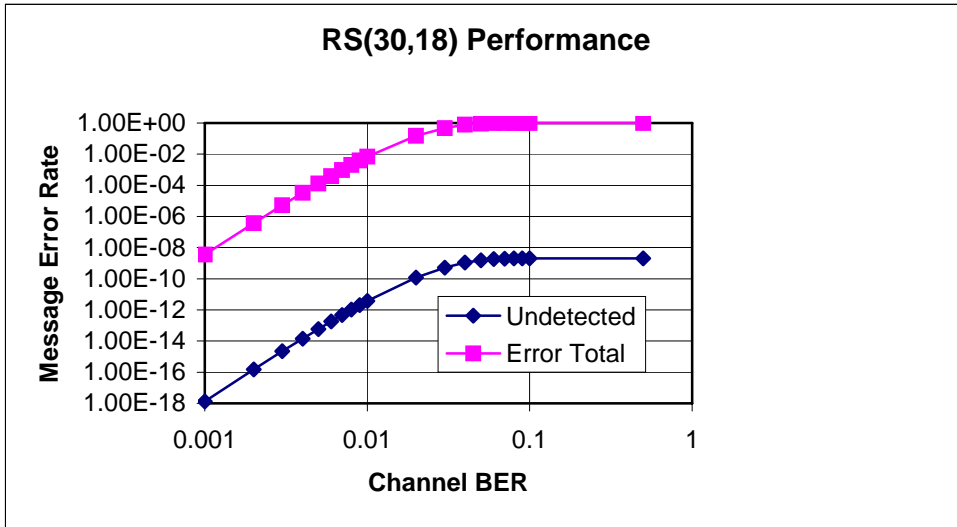

Figure E-1: Basic ADS-B Message Performance

(“Undetected” = P_U ; “Error Total” = P_E .)

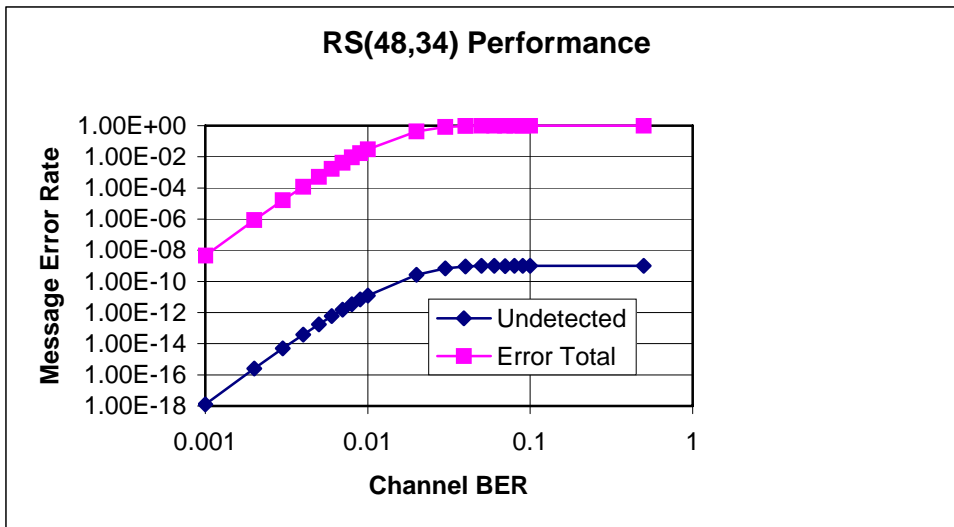

Figure E-2: Long ADS-B Message Performance

(“Undetected” = P_U ; “Error Total” = P_E .)

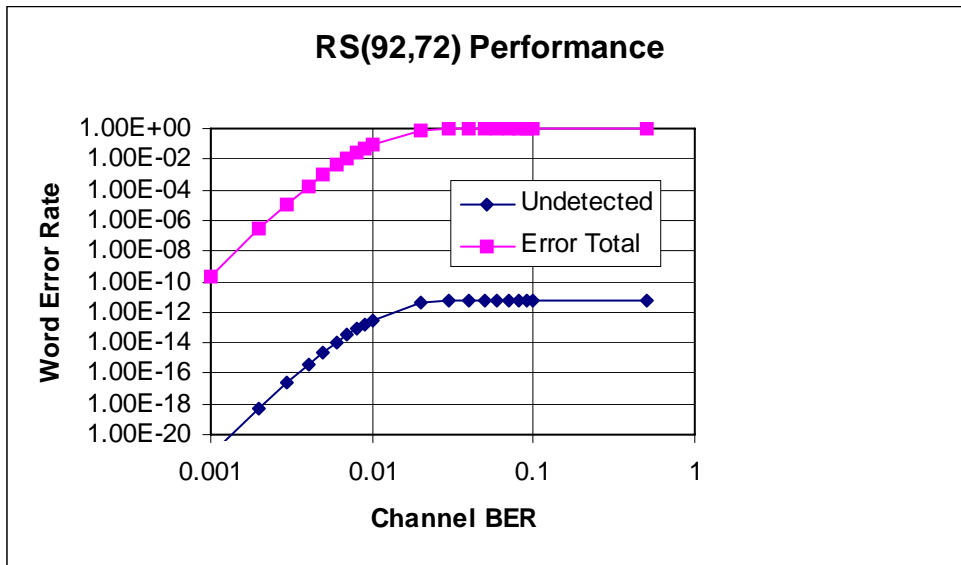

Figure E-3: Ground Up Link Message Performance

(“Undetected” = P_U ; “Error Total” = P_E .)

Note that for the ADS-B Messages, the word error rate is equal to the message error rate because there is one word per message. This is not true for the Ground Uplink Message. Figure E-3 shows the performance of a single RS (92, 72) word. The performance of an entire message, consisting of six words, is given by:

$$P_{Uburst} = (1 - P_E + P_U)^6 - (1 - P_E)^6 = (P_C + P_U)^6 - P_C^6$$

and

$$P_{Eburst} = 1 - (1 - P_E)^6 = 1 - P_C^6$$

Again, P_E is the total word error rate, and P_U is the undetected word error rate. A graph of the undetected message error rate versus the channel BER is shown in Figure E-4, which indicates that the maximum undetected error rate is about 1.3e-12, which occurs when the channel BER is about 0.012. To see why there is a maximum, consider the following approximation:

$$P_{UBurst} \approx 6P_U(1 - P_E)^5 .$$

The P_U term is small at low BER and the $(1 - P_E)^5$ term is small at high BER (because P_E is nearly 1 in that case).

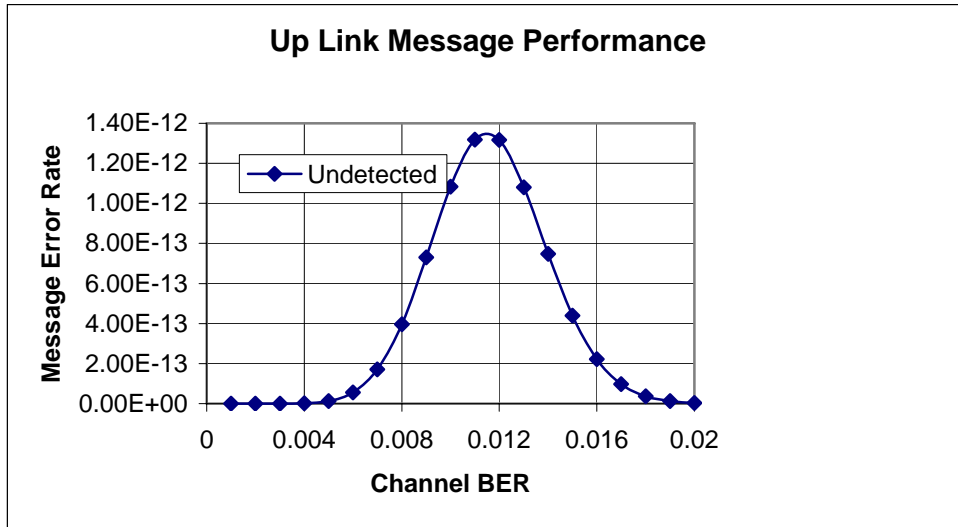

Figure E-4: Ground Up Link Message Undetected Message Error Rate

(“Undetected” = P_{UBurst} .)

For completeness, a graph of the total up link message error rate versus channel BER is also provided in Figure E-5.

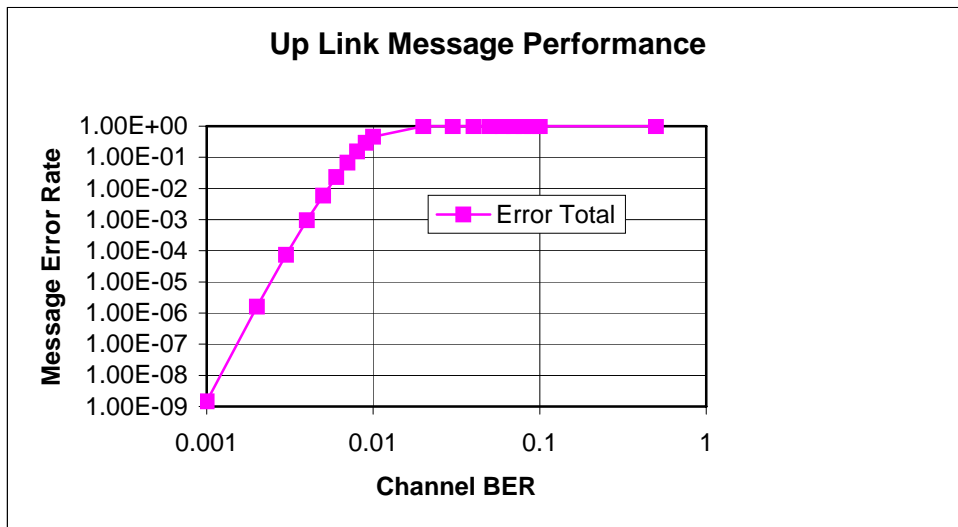

Figure E-5: Ground Up Link Message Total Message Error Rate

(“Error Total” = P_{EBurst} .)

Up to this point the discussion has dealt with the performance of the RS codes in the presence of noise that generates random bit errors. However, in addition to protecting against errors created by stationary and non-stationary interference (see Appendix B), the RS codes are also used as the sole means to differentiate between Long and Basic ADS-B messages. It is of interest to investigate the performance of this identification process.

In order to analyze this issue, it is useful to have a clear picture of the ADS-B reception process as defined in this document. The logical flow of the process is as shown in Figure E-6.

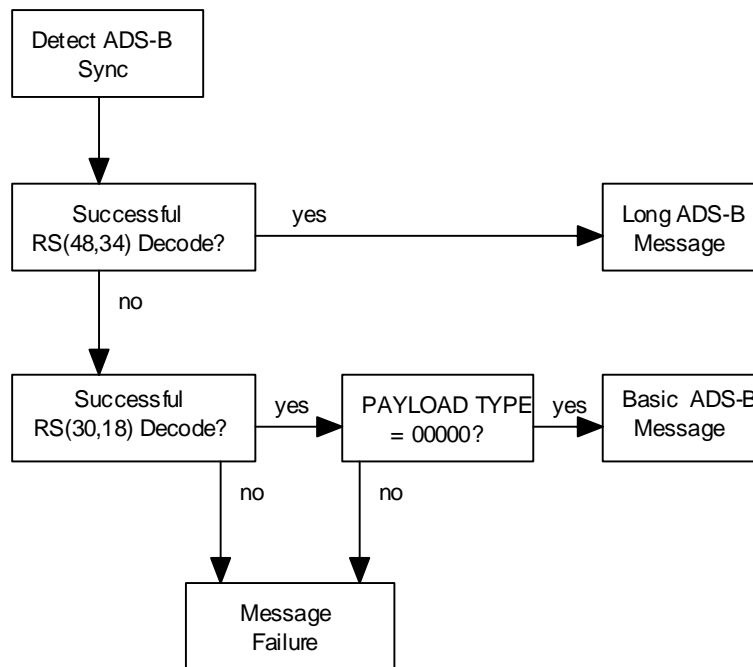

Figure E-6: Logical Flow of ADS-B Reception

After each successful detection of an ADS-B synchronization pattern, the receiver will first check if the RS (48,34) decoding process is successful. If so, the receiver will determine that a Long ADS-B message was actually sent. However, if this decoding process fails, the receiver will check if the RS(30,18) decoding process is successful. If it is, the message is a candidate Basic ADS-B message. As a final safeguard, the receiver will check if the 5 bits of the MESSAGE DATA BLOCK TYPE CODE field are all zeros. If this test is successful, the receiver will determine that a Basic ADS-B message was actually sent. If the MESSAGE DATA BLOCK TYPE CODE test fails or if the RS (30,18) decoding process fails, the entire message is discarded. (Note that this is a *logical* flow only. It is possible, for example, for the two RS decodes to be done in any time order.)

For this investigation there are two possible failure modes of interest. First, an actual Basic ADS-B message could be perceived as a Long ADS-B message. Second, a Long ADS-B message could be perceived as a Basic ADS-B message. These two will be discussed separately.

When a Basic message is received, it is first subjected to the RS (48,34) decoding process. The input to the decoder will be the 30 bytes of the Basic message (assumed to have no bit errors) plus 18 bytes of random data. Because the random part of the input to the decoder includes the entire parity check sequence, the probability of a successful decode is the same as the maximum undetected error rate

reported in Table E-1, i.e., 9.95×10^{-10} . Thus, there is about one chance in one billion that a particular Basic message will appear to be a Long Message.

Note that in the case above a RS (30,18) decoding attempt would have been successful if carried out, since there are assumed to be no bit errors. However, the decoding rules give precedence to a successful Long ADS-B decision.

When a Long ADS-B message is received, it also is subjected initially to the RS (48,34) decoding process. If there are no bit errors, then the decoding will succeed, and the message will correctly be determined to be a Long ADS-B message. However, the process will not succeed if there are more than 7 incorrect bytes. In that case the decoder may (with probability no greater than 9.95×10^{-10}) produce an undetected error, i.e., it will produce a Long ADS-B message different from the one that was sent. It is far more likely that the decoder will fail to produce any result, and the RS (30,18) decoding process will be attempted next.

From the point of view of the RS (30,18) decoder, the first 30 bytes of the Long ADS-B message are equivalent to a random sequence of 240 bits, except that the first five bits (the location of the MESSAGE DATA BLOCK TYPE CODE field) are not 00000. Thus, the decoding process must change the first byte to include 00000 in order to succeed. The probability of this occurring is given by the following equation:

$$p = \frac{8}{256^{12}} \cdot \sum_{k=0}^5 \binom{29}{k} 255^k = 1.29 \times 10^{-11}.$$

Checking for the correct MESSAGE DATA BLOCK TYPE CODE lowers the false decode probability from 2.06×10^{-9} to 1.29×10^{-11} .

During the development of UAT there was some concern that there might be an abnormally high probability of misinterpreting a Long ADS-B message as a Basic ADS-B message if there were a preponderance of zeros in the Message Data Block. This might happen if many of the fields were “stuffed” with zeros due to the unavailability of data. Since “all-zeros” is a valid RS code word and the RS (30,18) code can correct up to 6 erroneous bytes, the first 30 bytes of a Long ADS-B message will “successfully” decode to the all-zero Basic ADS-B message whenever 6 or less of the 30 bytes are nonzero. Because the RS (48,34) decoding process has precedence, this scenario requires that the Long decoding process must fail and the Basic decoding process must succeed. Normally, a BER high enough to cause the RS (48,34) decoding process to fail would turn enough of the zero bytes into nonzero bytes so that the RS (30,18) decoding process would also fail. However, it is possible that interference (e.g., another ADS-B message) could overlap only the tail end of a Long ADS-B message, leaving the first 30 bytes essentially intact. It is difficult to assess the likelihood that such a situation will arise since it depends on the number of potential interference sources and their relative signal strengths.

Whatever their probability might be, if the conditions described in the previous paragraph should prevail, the decoding process will incorrectly result in an all-zero Basic ADS-B message. This decoded message will pass the MESSAGE DATA BLOCK TYPE CODE test; however, this should *not* generate an operational problem because such a message will necessarily contain the all-zero ICAO address, which is invalid. Thus, in order to cope with this (very unlikely) situation, any application that uses a decoded ADS-B message could check the validity of the ICAO address before processing the remainder of the information.

As a final note it should be pointed out that the receiver could, as an option, check the MESSAGE DATA BLOCK TYPE CODE field of candidate Long ADS-B messages as well as of candidate Basic ADS-B messages. Checking that the MESSAGE DATA BLOCK TYPE CODE field is *not* 00000 will lower very slightly (by a factor of 31/32) the probability of undetected error in the presence of random bit errors. It will also lower the probability of interpreting a Basic ADS-B message as a Long ADS-B message by a factor of about 7; this probability is given by the following formula:

$$P = \frac{248}{256^{14}} \cdot \sum_{k=0}^6 \binom{47}{k} 255^k = 1.41 \times 10^{-10}.$$

This check is not a requirement since the improvement it provides is rather modest.

The information contained in this Appendix is summarized in Table E-2. The numbers presented are upper limits on the likelihood of potential ADS-B messages being misinterpreted. The first two rows assume that the input bit stream is corrupted by strong interference, and the entries are upper bounds on the probabilities of interpreting a Long (Basic) ADS-B message as an incorrect Long (Basic) ADS-B message. The other rows provide upper limits on the probabilities of incorrectly interchanging Long and Basic. The shaded cells represent the results obtained by using the optional check of the MESSAGE DATA BLOCK TYPE CODE field for Long ADS-B message candidates. Table E-2 does not address the likelihood of a successful synchronization being followed by a very high BER for all or part of the remaining message; the probability of encountering the interference conditions necessary for misinterpreting message length is certainly much less than 1.

Table E-2: Upper Bounds on Undetected Message Error Probabilities

Transmission	Perceived Reception	Raw Probability of Undetected Error	Probability with MESSAGE DATA BLOCK TYPE CODE Check
Long	Long	9.95e-10	9.64e-10
Basic	Basic	2.06e-9	6.45e-11
Basic	Long	9.95e-10	1.41e-10
Long	Basic	2.06e-9	1.29e-11

Reference [1]: Kasami, T., and S. Lin, 1984, "On the Probability of Undetected Error for Maximum Distance Separable Codes," IEEE Trans. Comm., COM-32,998-1006.

This page intentionally left blank.

Appendix F
DME Operation in the Presence of
UAT Signals

This page intentionally left blank.

F. DME Operation in the Presence of UAT Signals

This Appendix provides a summary of testing and analyses that verifies UAT compatibility with Distance Measuring Equipment (DME) and that DME equipment will operate without degradation in the presence of UAT signals.

Over the course of the development of the UAT MOPS (RTCA/DO-282A), numerous studies and analyses were performed on UAT compatibility and the DME environment. All of the Working Papers detailing the results of that analysis can be found on the ADS-B/UAT MOPS web site, which is located at:

<http://adsb.tc.faa.gov/WG5.htm>

The goal of the DME testing, conducted as a part of the UAT MOPS development, was to verify that UAT signals do not interfere with the proper operation of DMEs, which operate in the band in which UAT will operate. The focus of the bench testing herein was to conduct tests on DME units that were representative of the vast majority of the DMEs used in the different categories of aviation equipment. However, due to the large number of different manufacturers and types of DMEs, it was unrealistic to test all of the possible DMEs in the system. Four DME units were selected based on availability, and representing the different categories of avionics instrumentation. The specific models used in the testing were:

1. Bendix King KD-7000
2. Narco DME-890
3. Rockwell-Collins DME-900
4. Honeywell 706-A

The latter two were selected to represent units currently in use in the European Union.

The first phase of testing was to determine the impact of overlapping UAT signals onto the DME pulse pairs. The test configuration consisted of a victim DME interrogator connected to a DME ground station simulator and a UAT message source generating Long ADS-B UAT Messages. The DME ground station simulator received interrogations from the DME unit under test and transmitted replies as well as unsolicited pulse pairs to closely match the operation of an actual ground simulator. Since the selected frequency for UAT does not reside in the interrogation frequency band, the testing was configured with a clear interrogation channel. This assumption is consistent with standard DME interrogator test procedures and any interference on the interrogator channel would be manifested in the system as a reduction in transponder reply efficiency. The UAT frequency was tested co-channel with the DME reply frequency and testing was also conducted with DMEs located on adjacent DME channels. On the reply channel, every reply was completely overlapped with the same level of UAT interference. This is much more severe than any real world interference environment, but is appropriate for the purposes of the bench testing where performance under extreme conditions provides the data required to model real world scenario performance. A data point consists of measuring both the interfering signal level that prohibits the DME to acquire a track (Acquire Stable Operating Point [ASOP]) and the level that causes the

DME to lose a track that it has already acquired (Break Stable Operating Point [BSOP]). In general, it was found that these two levels were separated by approximately 1 dB.

One especially informative measurement was taken where ASOP and BSOP were determined as a function of the reply efficiency of the ground station. The simulator utilized in the test configuration had the capability to randomly reply to 0-100% of the interrogations it received. The measurements showed that the DME interrogator could acquire and track in the presence of the same level of UAT interference as long as at least 30% of its interrogations elicit replies. Each DME model tested could tolerate relatively high amplitude UAT interference, although each unit tolerated a slightly different level of interference. This seems to indicate that as long as a DME is able to receive more than 30% of the replies from its interrogations with interference less than the ASOP/BSOP point particular to that DME unit, it will operate. It is important to note that although this was a consistent characteristic of the four DME units tested, this may not be true of all DME units operating in the system. However, given the significant margin with respect to the 70% reply efficiency monitor limit, there is enough of a margin to have the confidence to apply these results to operational DMEs in the system.

The results of the bench test conducted are depicted in the following figures. Figure F-1 summarizes the data results of co-channel and adjacent channel DME operation of the Bendix King KD-7000 DME. The DME levels utilized were -68 dBm and -83 dBm and reply efficiency was set at 100%.

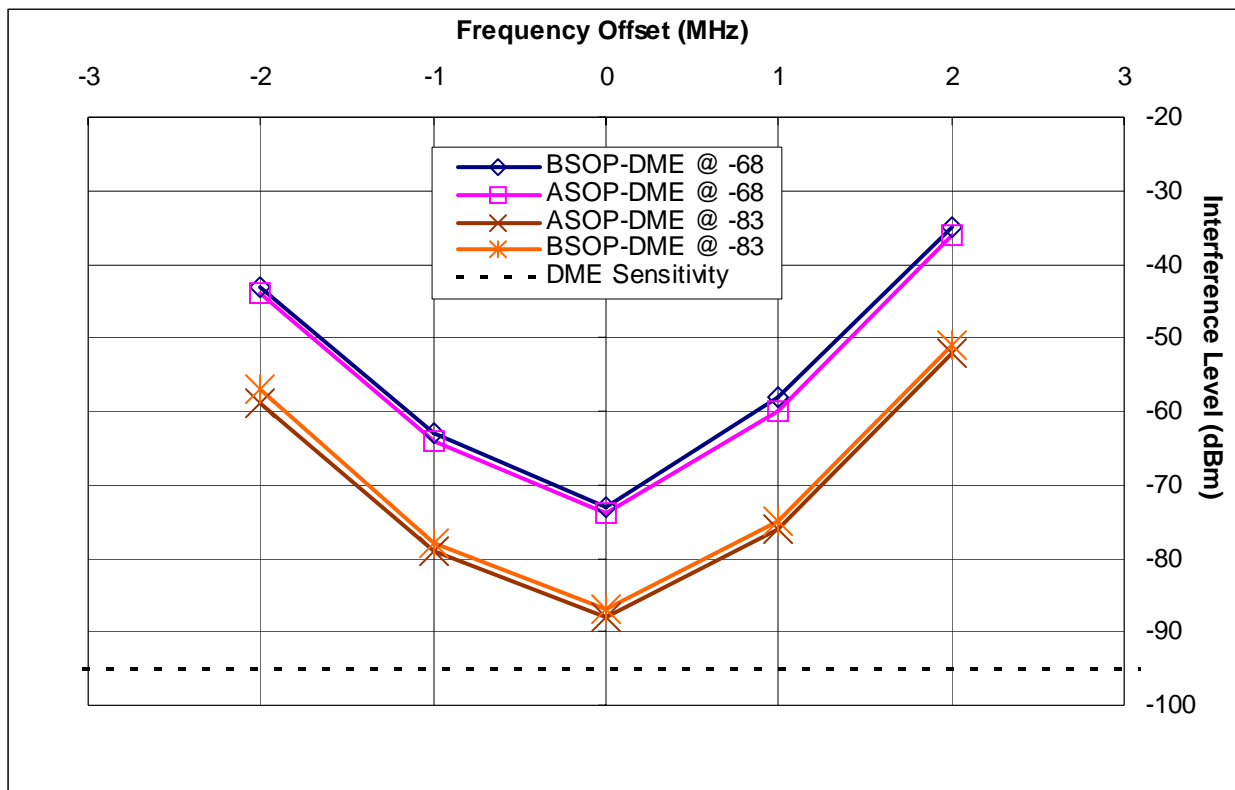

Figure F-1: Bendix King KD-7000 Frequency Offset Test

Figure F-2 depicts the performance of the Bendix King KD-7000 DME as a function of reply efficiency. DME levels of -68 dBm and -83 dBm were utilized and these signals were co-channel. This plot shows the consistent behavior of the DME as a function of reply efficiency above 30%.

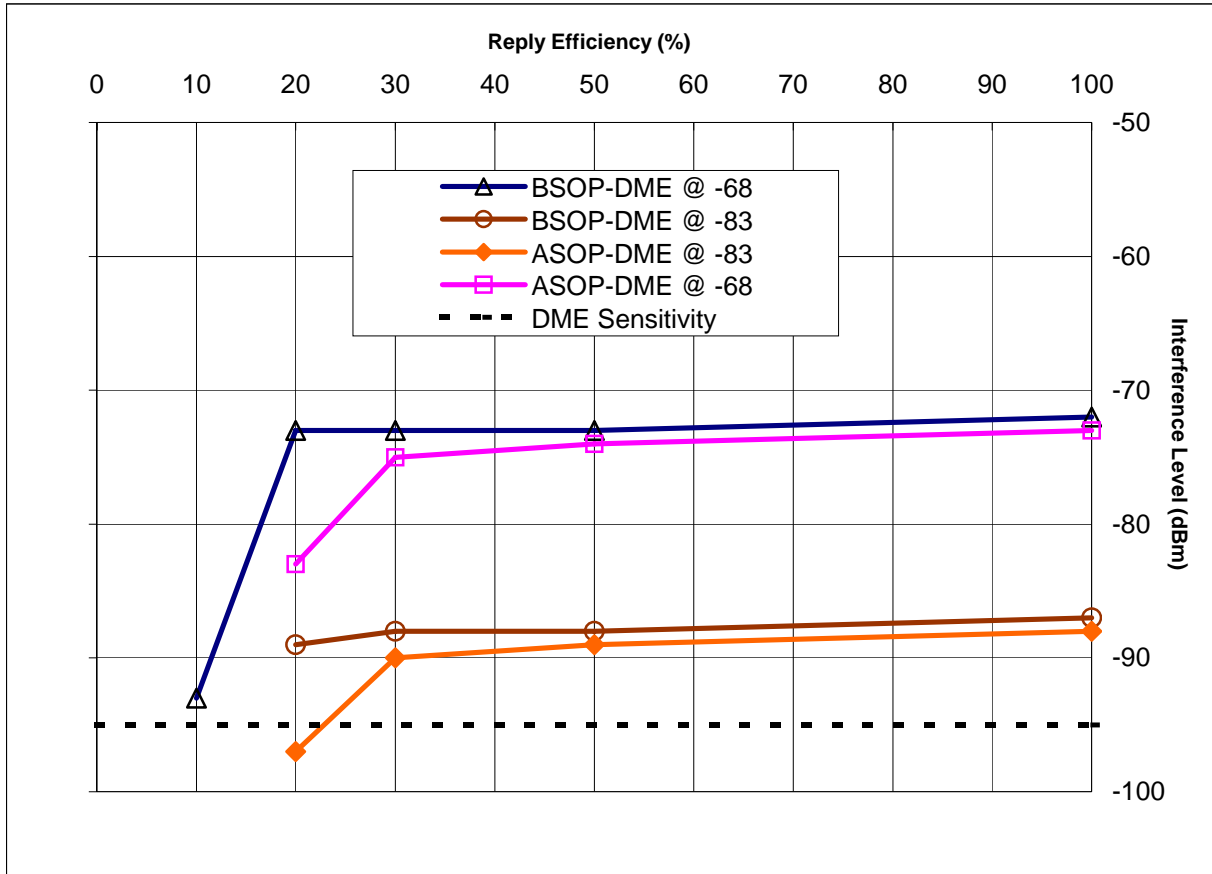

Figure F-2: Bendix King KD-7000 Reply Efficiency Test

Figure F-3 depicts the performance of the Bendix King when subjected to CW with a DME level of -83 dBm. The results are very similar to the UAT signal interference results as a function of frequency offset.

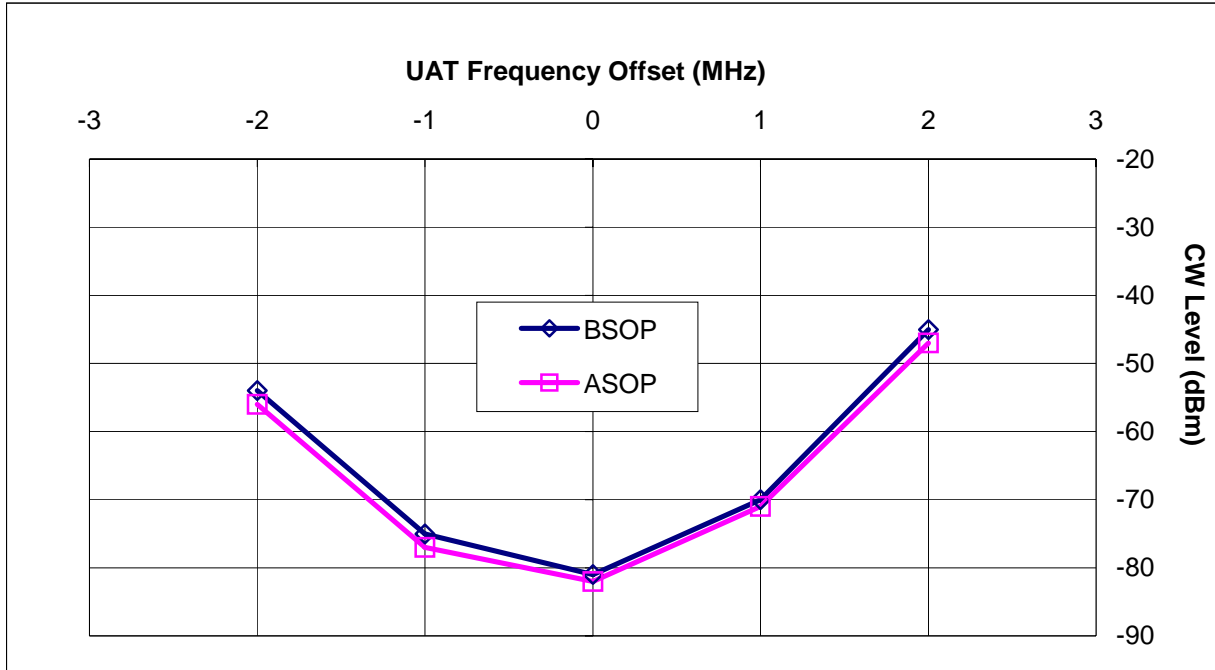

Figure F-3: Bendix King KD-7000 CW testing: DME level -83 dBm

Figure F-4 summarizes the data results of co-channel and adjacent channel DME operation of the Narco DME-890. The DME levels utilized were -60 dBm and -75 dBm. These amplitude levels were chosen to allow comparison with the other DME units at comparable levels above sensitivity. The Narco DME-890 had the least sensitive receiver of the four units that were measured at -81 dBm.

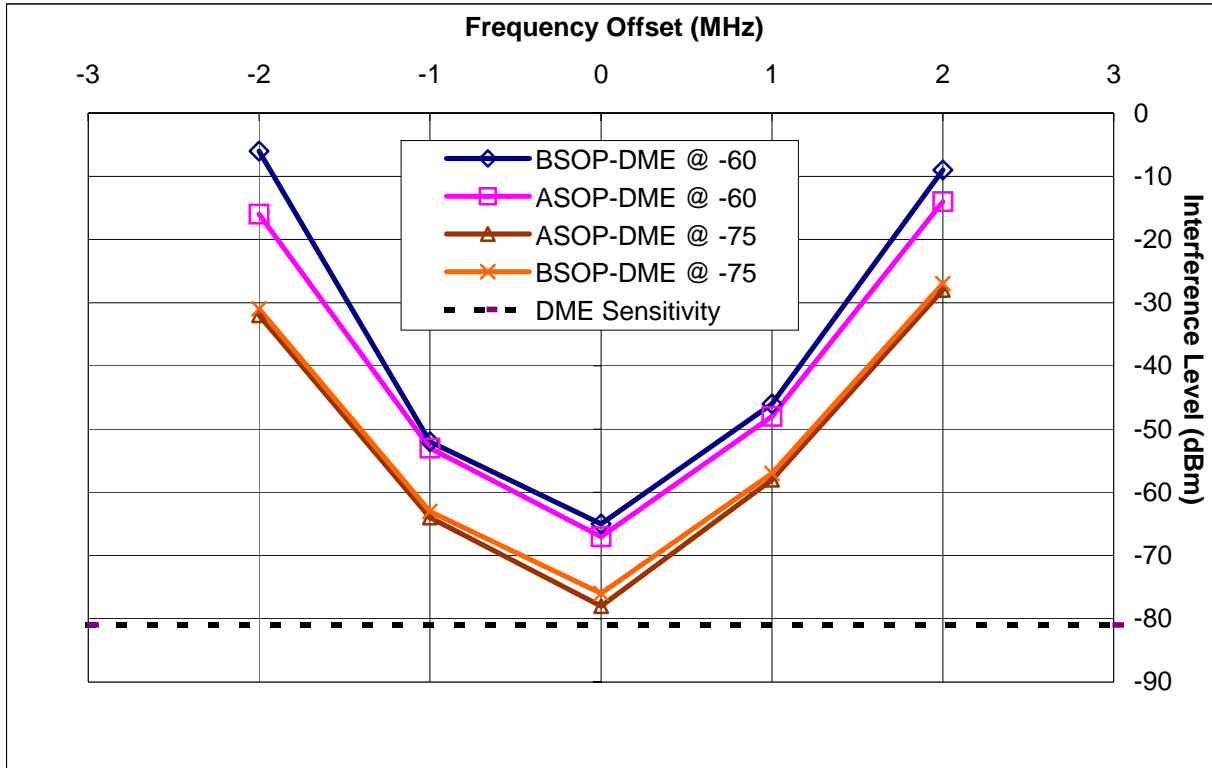

Figure F-4: Narco DME-890 Frequency Offset Test

Figure F-5 depicts the performance of the Narco DME-890 as a function of reply efficiency. DME levels of -60 dBm and -75 dBm were utilized and these signals were co-channel. As also seen in the behavior of Bendix King KD-7000, the performance is consistent as a function of reply efficiency above 30%. Figure F-6 depicts the performance of the Narco DME-890 when subjected to CW with a DME level of -75 dBm.

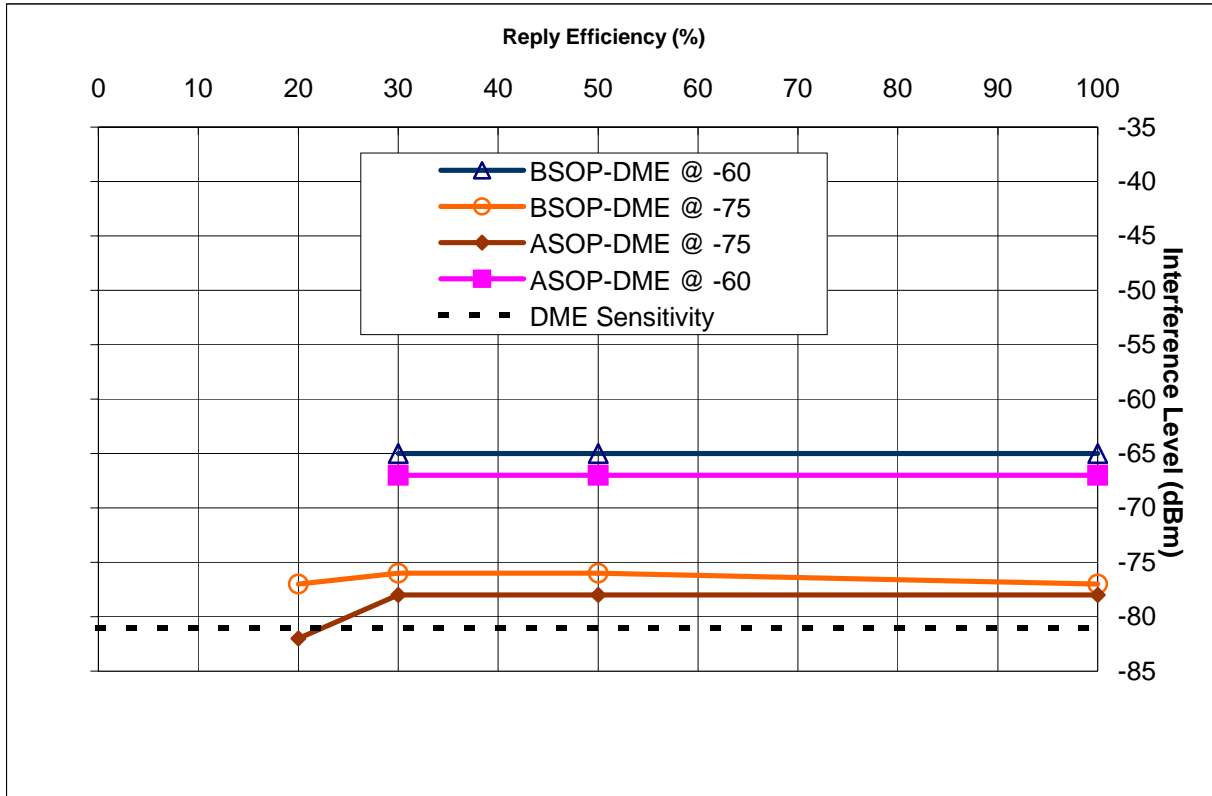

Figure F-5: Narco DME-890 Reply Efficiency Test

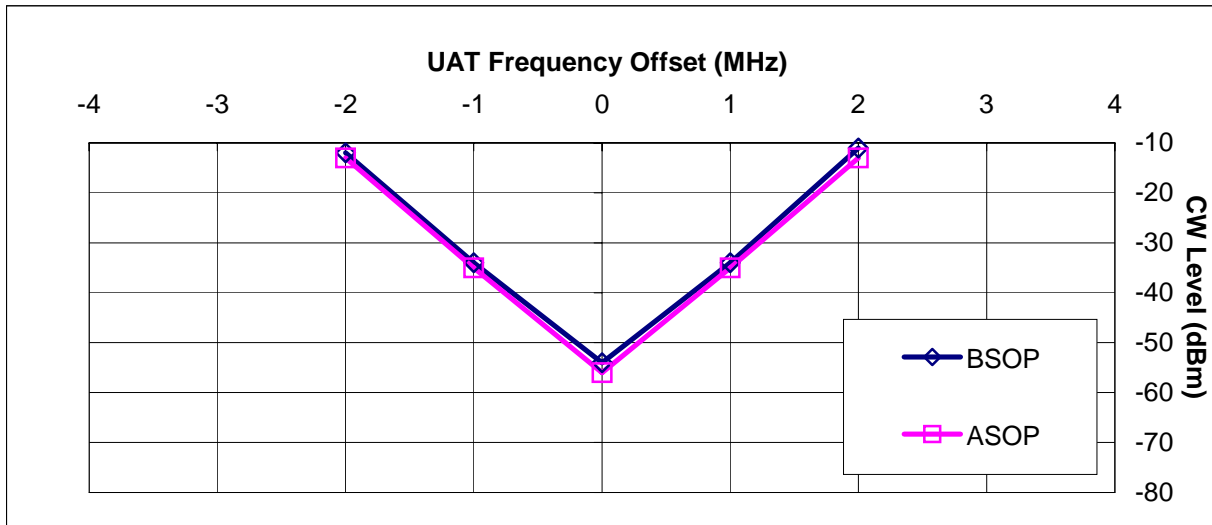

Figure F-6: Narco DME-890 CW testing: DME level -75 dBm

Figure F-7 summarizes the data results of co-channel and adjacent channel DME operation of the Honeywell KDM-706A DME. The DME levels utilized were -68 dBm and -83 dBm and reply efficiency was set at 100%.

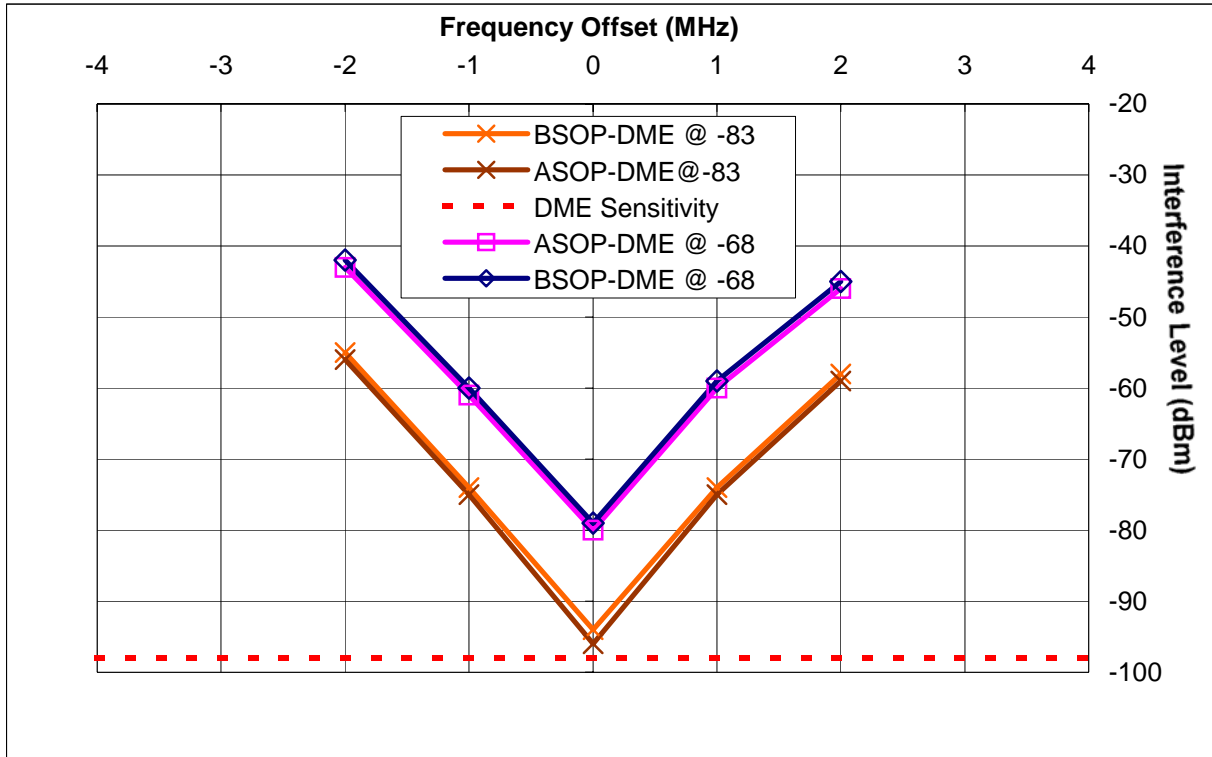

Figure F-7: Honeywell KDM-706A Frequency Offset Test

Figure F-8 depicts the performance of the Honeywell KDM-706A DME as a function of reply efficiency. DME levels of -68 dBm and -83 dBm were utilized and these signals were co-channel.

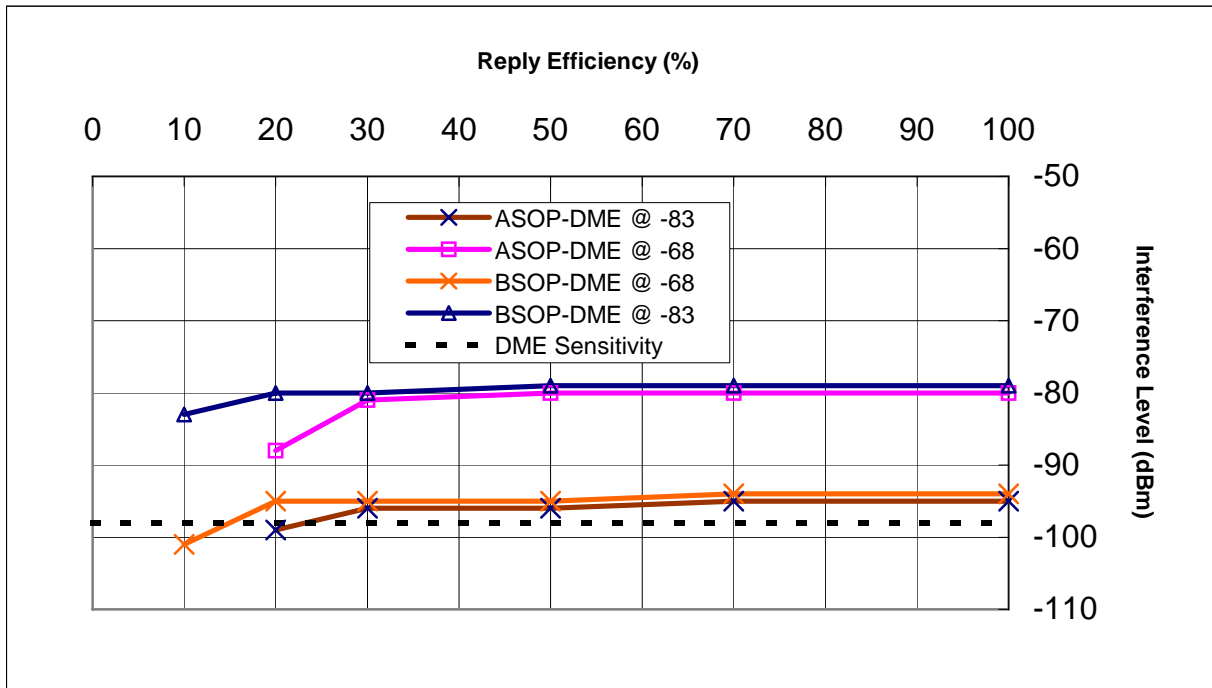

Figure F-8: Honeywell KDM-706A Reply Efficiency Test

Figure F-9 depicts the performance of the Honeywell KDM-706A DME when subjected to CW with a DME level of -83 dBm. As with the previous DME units, the results are very similar to the UAT signal interference results as a function of frequency offset.

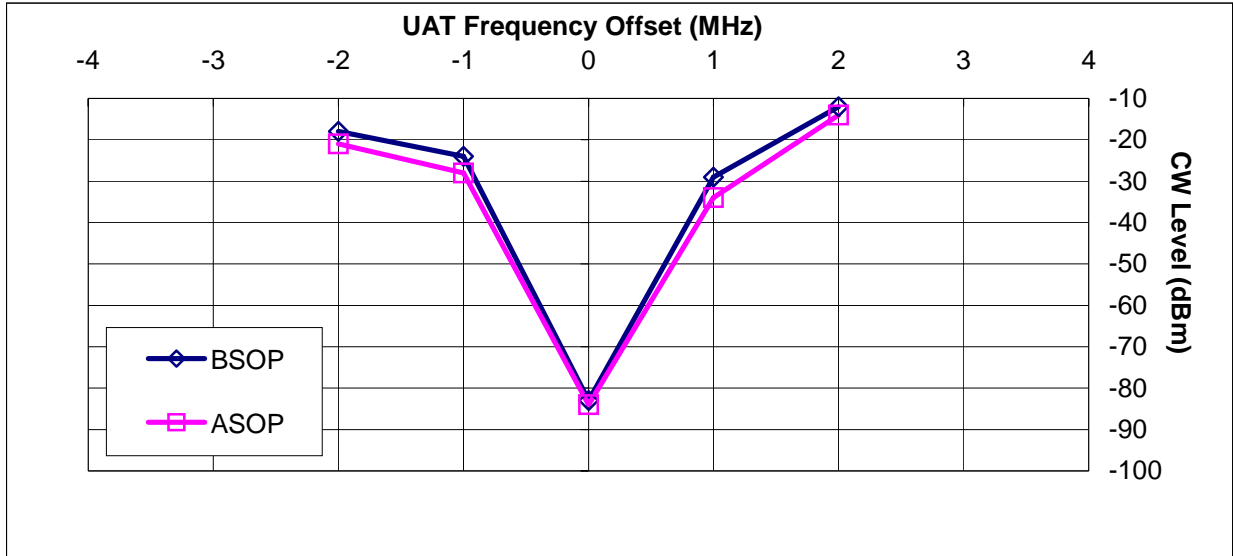

Figure F-9: Honeywell KDM-706A CW testing: DME level -83 dBm

Figure F-10 through Figure F-12 summarizes the data results of the Rockwell-Collins DME-900.

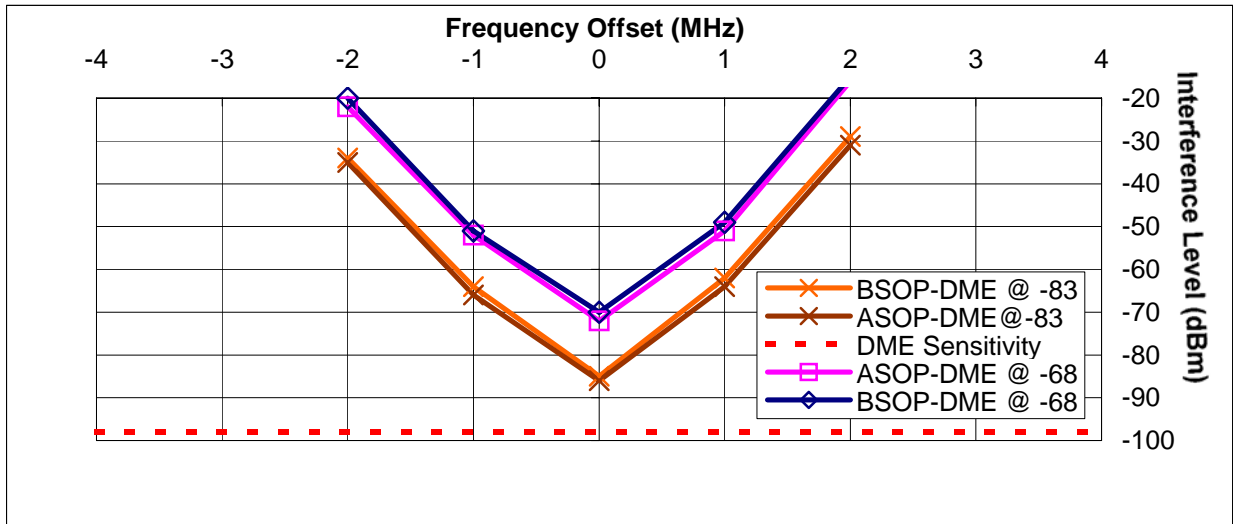

Figure F-10: Rockwell-Collins DME-900 Frequency Offset Test

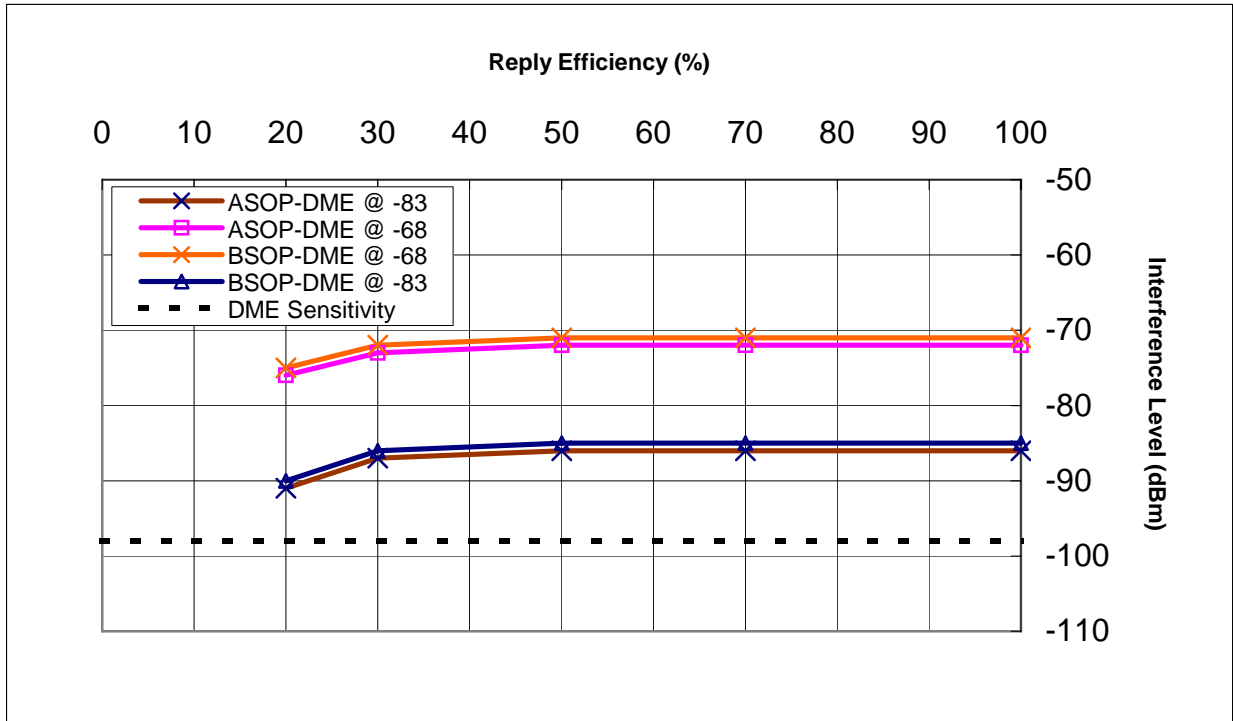

Figure F-11: Rockwell-Collins DME-900 Reply Efficiency Test

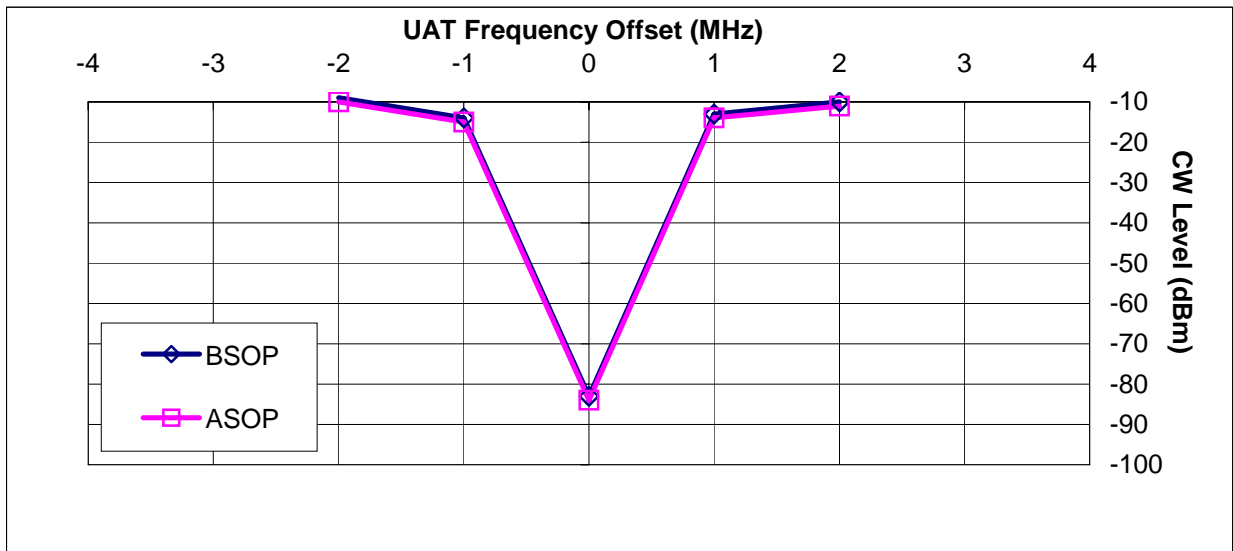

Figure F-12: Rockwell-Collins DME-900 CW testing: DME level -83 dBm

The comparisons of all four DME units tested are depicted in the following figures.

Figure F-13 summarizes the data results of co-channel and adjacent channel DME operation of the four DMEs. Figure F-14 depicts the performance of the four DMEs as a function of reply efficiency. Figure F-15 depicts the performance of all four DMEs when subjected to CW. As can be seen by the co-channel results in Figure F-13 and Figure F-15, the KDM-706A had the worst signal to interference rejection.

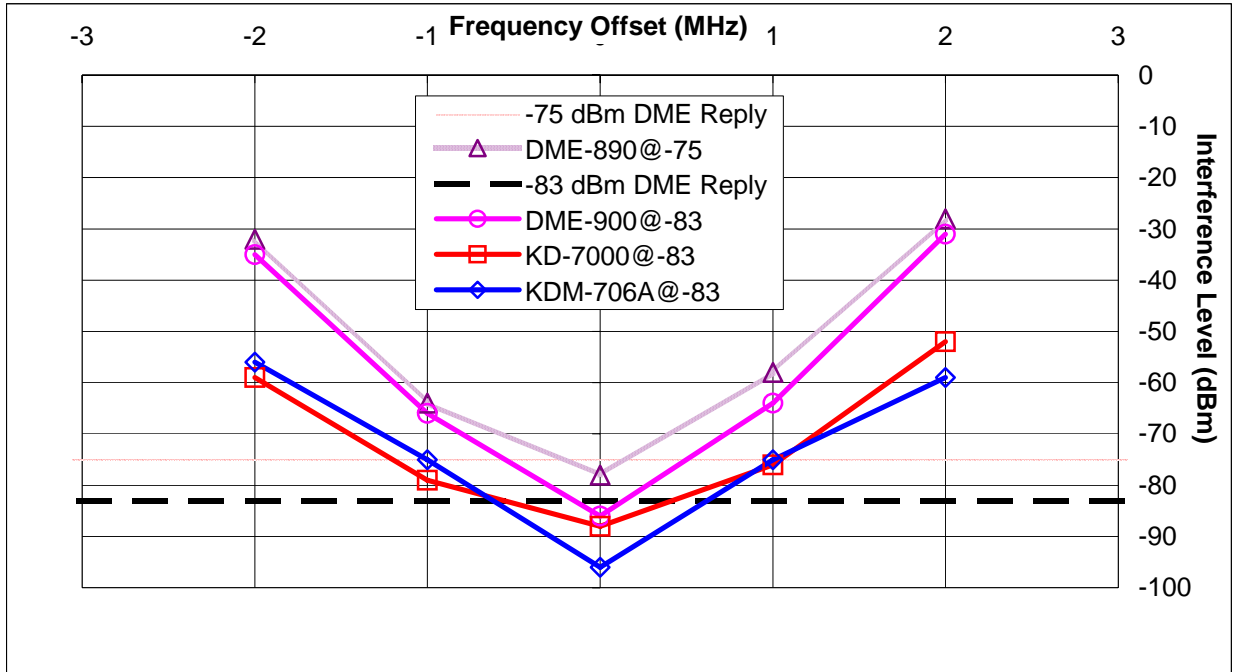

Figure F-13: Comparison of all DME Frequency Offset Tests

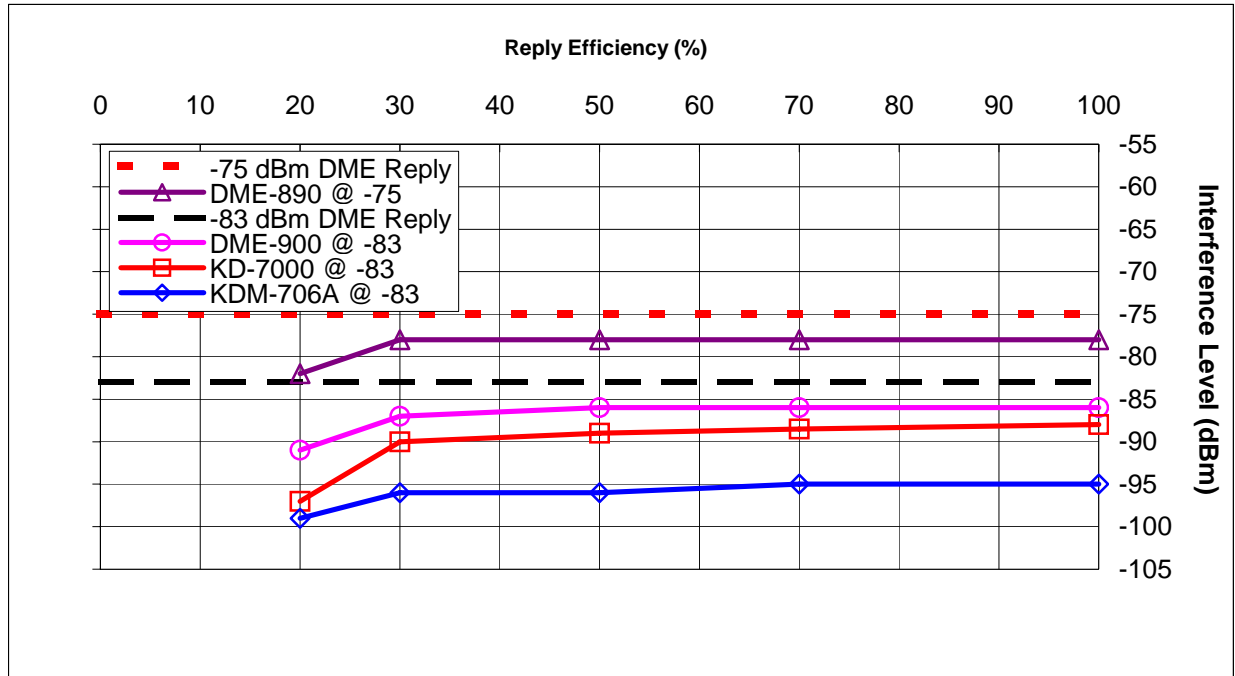

Figure F-14: Comparison of all DME Reply Efficiency Tests

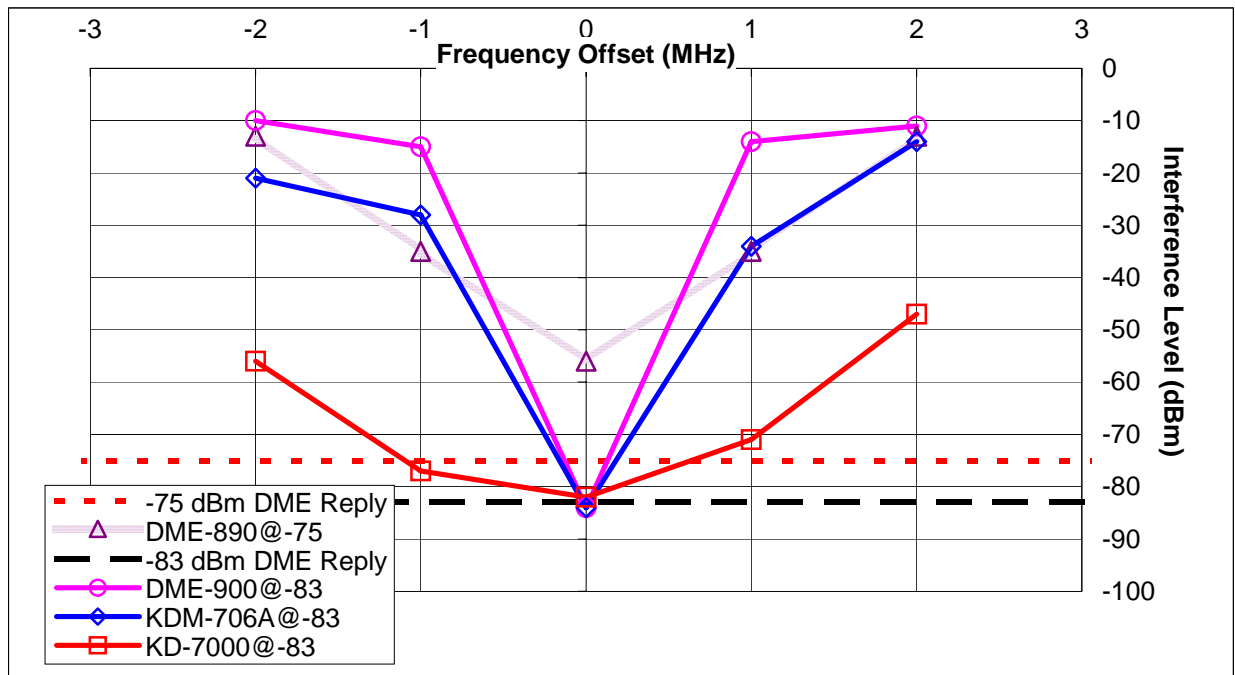

Figure F-15: Comparison of all DME CW Interference Tests

Using the combined data from the aforementioned bench testing and simulated high-density UAT traffic scenarios, the basis for making some basic conclusions on UAT and DME compatibility can be made. It can be determined, for example, at what desired signal level, which can then be converted into a range, that a particular DME can be

expected to stop working in a specified UAT environment. It can also provide a measure of how much of a margin is left for DME performance after UAT interference and other DME interference sources are considered. As shown by the bench results where all DME pulse pairs are directly overlapped by UAT Messages, the DMEs exhibit exceptional immunity to even co-channel UAT interference. The UAT/DME environments that must be considered span different time frames. In the near term, over approximately a ten year time interval, DMEs operating at 978 MHz are expected to be moved. However, over this time span, there will be DMEs operating at 978 MHz co-channel with UAT in a number of European locations. In the longer term after these DMEs are moved, the closest DME will be 1 MHz away from the UAT 978 MHz frequency. Upon examining the bench test results, the consistent behavior of the DMEs at a given UAT interference level down to reply efficiency of 30%, can be utilized to make conclusions of UAT effect on DME in the projected environments. If one analyzes the Core Europe 2015 scenario to determine the probability of overlapping a DME pulse pair at or above the UAT interference level that would cause loss of operation, it can be determined that the DME will operate without any measurable degradation in that environment. For example, taking the co-channel Honeywell KD-7000 DME unit results with a desired signal level of -83 dBm, UAT signals at or above -96 dBm could potentially impair DME operation if the reply efficiency reduced to 30% or below. Taking the Core Europe 2015 scenario and looking at the number of UAT messages at a level of -96 dBm or above, on average, less than 900 messages per second would be received if a DME receiver is positioned over Brussels at 40,000 feet. This is the same aircraft location used in the high density Core Europe 2015 analysis in Appendix K. The probability of overlap is significantly less than the minimum probability that would cause probability of reception to be reduced to the level that would impact DME operation. Since the co-channel case would not occur at the aircraft densities produced by the Core Europe 2015 scenario, the operation of DMEs on 978 MHz can be safely achieved. Since the co-channel DME case is validated for Core Europe 2015, the DME channels 1 MHz or more from the UAT occupied frequency will not be impacted given there is on average 10 dB additional protection shown by the bench test results when the DME is 1 MHz away from UAT signals.

The UAT environment described in Appendix B, the Core Europe 2015 scenario, represents the future environment under which DMEs and UAT were examined to verify that proper operation would be maintained. A bench measurement with a DME unit subjecting the victim DME to the Core Europe 2015 UAT environment was performed to validate that DMEs would properly operate in the future UAT environment. Utilizing a UAT Message Generator, which produced UAT signal environments for model validation efforts described in Appendix B, the Core Europe 2015 UAT Messages that would be experienced by a victim airborne DME receiver were input to the DME receiver. Performance as a function of DME signal amplitude was examined. Rate, timing and amplitudes of UAT Messages for this scenario represent a more realistic worst-case scenario than the conditions under which the bench tests were conducted. The testing was conducted on the Narco DME-890 and the results were measured to determine the DME level to achieve ASOP. This was compared to the measured sensitivity of the DME unit without interference. The results indicated that when the DME unit is subjected to the future UAT environment, it was able to achieve ASOP within 1 dB of its normal sensitivity without UAT interference.

Further examination of the effect of UAT on DME was performed to examine the combined effect of UAT and JTIDS on DME. Since the bench results and analysis indicates significant margin before UAT would impact DME operation, it was not

expected that UAT combined with JTIDS would result in an impact on DME operation. An analysis was performed to determine quantitatively how much interference JTIDS could produce relative to the UAT signal interference produced by the Core Europe 2015 environment. Figure F-16 depicts the incremental change in interference that would be experienced by a DME receiver by the combined effect of UAT and JTIDS when compared to UAT interference alone in the ADS-B segment of the UAT Frame. The CDF is a measure of the percentage time that interference is experienced by the victim DME receiver at or below the corresponding interference signal level. This analysis was performed with the DME and UAT co-channel in the Core Europe 2015 scenario and the JTIDS Baseline B scenario described in Appendix G. As observed by the results, the combination of JTIDS and UAT is not significantly different than UAT interference alone.

In summary, a significant amount of testing on 4 models of DME equipment representative of the existing equipment population was performed to validate proper operation of DMEs when subjected to UAT signals. This testing has shown the DME interrogators to be very tolerant to the UAT signal even when operated co-channel with UAT. Based on tests conducted to date, no compatibility issues are expected with DME operation even when operated co-channel with UAT even with very high levels of future UAT/ADS-B equipage in high density European airspace.

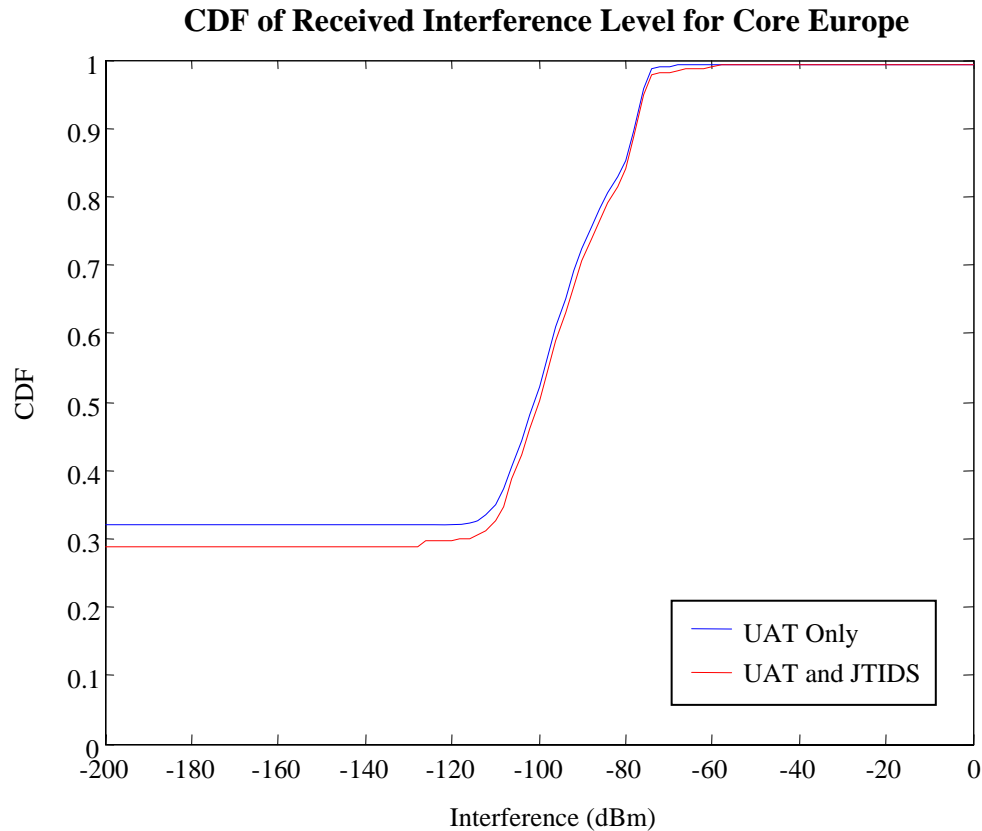

Figure F-16: JTIDS and UAT Combined Interference Analysis

Appendix G

Example ADS-B Message Encoding

This page intentionally left blank.

G. Example ADS-B Message Encoding

G.1 Reed Solomon Encoding of Message Data Block

The encoding is accomplished by means of a **systematic** RS 256-ary code with 8 bit code symbols (Bytes). The first parity symbol out of the FEC encoder is treated as the most significant symbol of the parity sequence. The parity check symbols are appended to the trailing end of the sequence of data symbols.

The ordering of the Bytes is from MSB to LSB, left to right, as they enter and exit the Reed Solomon encoder, as is the ordering of the bits within each Byte (MSB to LSB). When treated as polynomial coefficients this is equivalent to transmitting the high order coefficient(s) first. Since the systematic Reed Solomon Code is defined over the Galois Field $GF(2^8)$, using the primitive polynomial [with binary coefficients, i.e., $GF(2)$] given as:

$$p(x) = x^8 + x^7 + x^2 + x + 1$$

all of the non-zero elements of the extension field $GF(256)$ can be described as powers of a root of $p(x)$; that is, for α such that $p(\alpha) = 0$, the nonzero elements of $GF(256)$ are given as α^m , for $m = 0, 1, 2, \dots, 254$ (where $\alpha^{255} \equiv \alpha^0 = 1$). For example,

$$\alpha^8 \equiv \alpha^7 + \alpha^2 + \alpha + 1 = (1,0,0,0,0,1,1,1) \text{ as a binary 8-tuple (Byte).}$$

To complete the description of the extension field elements, the “zero” element (additive identity) is denoted as $\mathbf{0} = (0,0,0,0,0,0,0,0)$.

The generator polynomial for the Reed Solomon codes is given as:

$$G(x) = \prod_{i=120}^P (x - \alpha^i)$$

where $P = 131$ for RS (30,18) and $P = 133$ for RS (48,34) codes used for two ADS-B messages.

G.2 Reed Solomon Encoding of Basic Type 0 ADS-B Message Data Block

The generator polynomial for the RS (30,18) Reed Solomon code is given as:

$$G(x) = x^{12} + \alpha^{76} x^{11} + \alpha^{66} x^{10} + \alpha^{157} x^9 + \alpha^{28} x^8 + \alpha^{92} x^7 + \alpha^{220} x^6 + \alpha^{88} x^5 + \alpha^{20} x^4 + \alpha^{145} x^3 + \alpha^{50} x^2 + \alpha^{56} x + \alpha^{231}$$

Table G-1 represents an example of a Basic ADS-B Message Data Block with selected values for individual fields and the equivalent bit oriented representation. Each data field from Table G-1 is arranged in sequence as shown to depict the transmitted Basic ADS-B Message data sequence.

Transmitted Basic ADS-B Message Data Byte #

MSB	1	2	3	4	5	6	7
	0000 0000	1111 1010	1010 0001	0010 0011	0101 0101	0101 0101	0101 0101
	8	9	10	11	12	13	14
	1100 0000	0000 0000	0000 0000	0000 0011	0101 0100	0000 0110	0100 0100
	15	16	17	18			
	0011 0010	1100 0000	0010 1000	0000 0000 _{LSB}			

Table G-1: Example of Basic ADS-B Message Data Blocks

Data Field	Value	Bit-Oriented Equivalent
Message Data Block Type Code	0	0 0000
Address Qualifier	0	000
Aircraft Address	FAA123 (HEX)	1111 1010 1010 0001 0010 0011
Latitude (WGS-84)	60° N	010 1010 1010 1010 1010
Longitude (WGS-84)	45° W	1110 0000 0000 0000 0000 0000
Altitude Type	0	0
Altitude	300 feet	0000 0011 0101
NIC	4	0100
Air/Ground State	0	00
[Reserved Bit]	0	0
North Velocity or Ground Speed	400 knots North	001 1001 0001
East Velocity or Heading	100 knots East	000 0110 0101
Vertical Velocity	+64 feet/minute (UP)	100 0000 0010
UTC coupled	1 (YES)	1
[Reserved Bits]	0	000
[Reserved Byte]	0	0000 0000

Note: The Message Data Block field definition of ADS-B Type 0 and Type 1 Messages in Table G-1 and Table G-2 respectively are current as of issue of the UAT MOPS (RTCA/DO-282A). These two messages are given as an example to describe how the field element α is defined within each symbol and how the

data symbols sequence enter RS encoder and exit with FEC parity sequence at its trailing end.

In generating the FEC, the ADS-B Message data bits are arranged into eight bit bytes assuming that the leftmost byte is the Most Significant Byte. The encoder accepts the 18 information symbols (Bytes) as:

$$\leftarrow [0, \alpha^{165}, \alpha^{124}, \alpha^{232}, \alpha^{84}, \alpha^{84}, \alpha^{84}, \alpha^{105}, 0, 0, \alpha^{99}, \alpha^{214}, \alpha^{100}, \alpha^{143}, \alpha^{222}, \alpha^{105}, \alpha^{201}, 0]$$

and generates the 12 symbols parity sequence:

$$\leftarrow [\alpha^{60}, \alpha^{145}, \alpha^{41}, \alpha^{128}, \alpha^{120}, \alpha^{183}, \alpha^{138}, \alpha^{76}, \alpha^{220}, \alpha^{90}, \alpha^{175}, \alpha^{71}]$$

The parity sequence is then appended to the (right) end of the information sequence to complete the 30 symbols Codeword for transmission (left symbol first).

MSB	ADS-B Basic Message Data Block Bits + FEC Parity Bits
0000 0000	1111 1010 1010 0001 0010 0011 0101 0101 0101 0101 0101 0101 1100 0000 0000 0000
0000 0000	0000 0011 0101 0100 0000 0110 0100 0100 0011 0010 1100 0000 0010 1000 0000 0000
1111 1110	1001 0111 1100 0100 0011 0100 1110 0001 1111 1111 0101 0011 0110 0101 1100 1111
1000 1111	1010 1111 1110 0100 _{LSB}

G.3 Reed Solomon Encoding of Long Type 1 ADS-B Message Data Block

The generator polynomial for the RS (48,34) Reed Solomon code is given as:

$$G(x) = x^{14} + \alpha^{82} x^{13} + \alpha^{49} x^{12} + \alpha^{21} x^{11} + \alpha^{70} x^{10} + \alpha^{26} x^9 + \alpha^{140} x^8 + \alpha^{135} x^7 + \alpha^{138} \alpha^6 \\ + \alpha^{22} x^5 + \alpha^{64} x^4 + \alpha^{13} x^3 + \alpha^{39} x^2 + \alpha^{70} x + \alpha^{241}$$

Table G-2 represents an example of Long Type 1 ADS-B Message Data Block (Basic ADS-B State Vector plus MS [Mode Status] elements, and AUX State Vector report elements fields) and the equivalent bit oriented representation.

Table G-2: Example of Long Type 1 ADS-B Message Data Blocks

Data Field	Value	Bit-Oriented Equivalent
Message Data Block Type Code	1	0 0001
Address Qualifier	0	000
Aircraft Address	FAA123 (HEX)	1111 1010 1010 0001 0010 0011
Latitude (WGS-84)	60° N	010 1010 1010 1010 1010
Longitude (WGS-84)	45° W	1110 0000 0000 0000 0000 0000
Altitude Type	0	0
Altitude	+300 feet	0000 0011 0101
NIC	4	0100
Air/Ground State	0	00
[Reserved Bit]	0	0
North Velocity or Ground Speed	400 knots North	001 1001 0001
East Velocity or Heading	100 knots East	000 0110 0101
Vertical Velocity	+64 feet/minute(UP)	100 0000 0010
UTC coupled	1(YES)	1
[Reserved Bits]	0	000
Emitter Category Code and Call Sign Characters#1 and #2	2 (Small) and "AB"	0000 1110 0001 1011
Call Sign Characters#3, #4, and #5	"CD1"	0100 1101 0000 1001
Call Sign Characters#6, #7, and #8	"234"	0000 1100 1111 1100
Emergency	0	000
MOPS Version	1	001
SIL	0	00
TMSO(6 LSBs of 12-bit MSO #)	1250 (only 6 LSB is transmitted)	10 0010
[Reserved Bits]	0	00
NAC _P	7	0111
NAC _V	2	010
NIC _{BARO}	0	0
Capability Class (CC) Codes	0	00
Operational Mode (OM) Codes	0	000
True Magnitude	0	0
[Reserved Bits]	0	00 0000 0000 0000 0000
Secondary Altitude	+300 feet	0000 0011 0101
[Reserved Bits]	0	0000 0000 0000 0000 0000 0000 0000

Note: The Message Data Block field definition of ADS-B Type 0 and Type 1 Messages in Table G-1 and Table G-2 respectively are current as of issue of the UAT MOPS (RTCA/DO-282A). These two messages are given as an example to describe how the field element α is defined within each symbol and how the data symbols sequence enter RS encoder and exit with FEC parity sequence at its trailing end.

Each data field from Table G-2 is arranged in sequence as shown to depict the transmitted Long Type 1 ADS-B Message data sequence.

Transmitted Long Type 1 ADS-B Message Data Bytes #

MSB----1	2	3	4	5	6	7
0000 1000	1111 1010	1010 0001	0010 0011	0101 0101	0101 0101	0101 0101
8	9	10	11	12	13	14
1100 0000	0000 0000	0000 0000	0000 0011	0101 0100	0000 0110	0100 0100
15	16	17	18	19	20	21
0011 0010	1100 0000	0010 1000	0000 1110	0001 1011	0100 1101	0000 1001
22	23	24	25	26	27	28
0000 1100	1111 1100	0000 0100	1000 1000	0111 0100	0000 0000	0000 0000
29	30	31	32	33	34	
0000 0000	0000 0011	0101 0000	0000 0000	0000 0000	0000 0000	LSB

In generating the FEC, the ADS-B Message data bits are arranged into eight bit bytes assuming that the leftmost byte is the Most Significant Byte. The encoder accepts the 34 information symbols (Bytes) as:

$$\leftarrow [\alpha^3, \alpha^{165}, \alpha^{124}, \alpha^{232}, \alpha^{84}, \alpha^{84}, \alpha^{84}, \alpha^{105}, \underline{0}, \underline{0}, \alpha^{99}, \alpha^{214}, \alpha^{100}, \alpha^{143}, \alpha^{222}, \alpha^{105}, \alpha^{201}, \alpha^{107}, \alpha^{49}, \alpha^{117}, \alpha^{205}, \alpha^{101}, \alpha^{58}, \alpha^2, \alpha^{144}, \alpha^{34}, \underline{0}, \underline{0}, \underline{0}, \alpha^{99}, \alpha^{202}, \underline{0}, \underline{0}, \underline{0}]$$

and generates the 14 symbol parity sequence:

$$\leftarrow [\alpha^{107}, \alpha^{221}, \alpha^{159}, \alpha^{183}, \alpha^{133}, \alpha^{63}, \alpha^{240}, \alpha^{100}, \alpha^{51}, \alpha^{146}, \alpha^{15}, \alpha^{13}, \alpha^{206}, \alpha^{35}]$$

The parity sequence is then appended to the (right) end of the information sequence to complete the 48 symbols Codeword for transmission (left symbol first).

MSB	Long Type 1 ADS-B Message Data Block Bits + FEC Parity Bits														
0000 1000	1111 1010	1010 0001	0010 0011	0101 0101	0101 0101	0101 0101	0101 0101	1100 0000	0000 0000	0000 0000	0000 0000	0000 0000	0000 0000	0000 0000	0000 0000
0000 0000	0000 0011	0101 0100	0000 0110	0100 0100	0011 0010	1100 0000	0010 1000	0000 1110	0000 1100	1111 1100	0000 0100	1000 1000	0111 0100	0000 0000	0000 0000
0001 1011	0100 1101	0000 1001	0000 1100	1111 1100	0000 0100	1000 1000	0111 0100	0000 0000	0000 0000	0000 0000	0000 0000	0000 0000	0000 1110	0001 1001	0000 0000
0000 0000	0000 0000	0000 0011	0101 0000	0000 0000	0000 0000	0000 0000	0000 0000	0000 0000	0000 0000	0000 1110	0001 1001	1000 0101	1111 1111	1001 1100	0110 1011
1000 0101	1111 1111	1001 1100	0110 1011	0011 0011	0000 0110	0110 1100	1010 1001	1111 0100	0011 1101	0001 0010	1110 1000	LSB			

Appendix G References

References for forward Error Coding and the Galois Field are listed below:

- G-1. Peterson, W.W., and E.J. Weldon, Jr., Error-Correcting Codes, 2nd ed., MIT Press, Cambridge, MA, 1972.
- G-2. Michelson, A. M., and A. H. Levesque, Error-Control Techniques for Digital Communication, John Wiley & Sons, New York, NY 1985.

Appendix H

Aircraft Antenna Characteristics

This page intentionally left blank.

H. Aircraft Antenna Characteristics

H.1 Antenna Characteristics

H.1.1 General Characteristics

The UAT System is expected to be able to utilize any standard transponder/DME antenna. Potential sharing of existing transponder antennas is discussed in Section H.3 below. The antenna must be suitable to receive and transmit vertically polarized signals at 978 MHz. The VSWR produced by the antenna into a manufacturer specified load must not exceed 1.7:1 at 978 MHz +/- 1 MHz.

H.1.2 Radiation Patterns

Performance of the UAT ADS-B System was estimated using a model of antenna gain that was developed for the United States Federal Aviation Administration (FAA) Safe Flight – 21 (SF-21) Technical Link Assessment Team (TLAT) Report. See Appendix B of this document. In practice, equipment designers assume 0.5 dB less average gain in the azimuth plane than that given in the TLAT Antenna Gain Model. However, in data links such as UAT, which are interference limited, this difference should not be expected to affect the performance presented in Appendix B of this document.

H.1.3 Directional Gain Radiation Patterns

For some applications (such as applications specific to Class A3 equipment), it may be suitable to use antennas with directional gain patterns to increase the range in the forward direction. Limitations on such directional gain antennas include not creating undesired nulls in the azimuth pattern, maintaining the minimum air-to-air range in the aft direction, and ensuring that any future requirements for minimum air-to-ground range are met. This subparagraph contains some examples of antennas that can achieve these goals.

The Figure H-1 shows the azimuth pattern of an antenna that has been evaluated through the development of the ADS-B 1090 MHz Extended Squitter MOPS (RTCA DO-260A). This antenna achieves its gain through use of passive reflector elements. The antenna has a peak gain of 7.5 dBi, and a F/B ratio of 5 dB. This antenna could be easily scaled for 978 MHz, or undergo additional investigation to determine its characteristics as a combined antenna for both 978 and 1090 MHz.

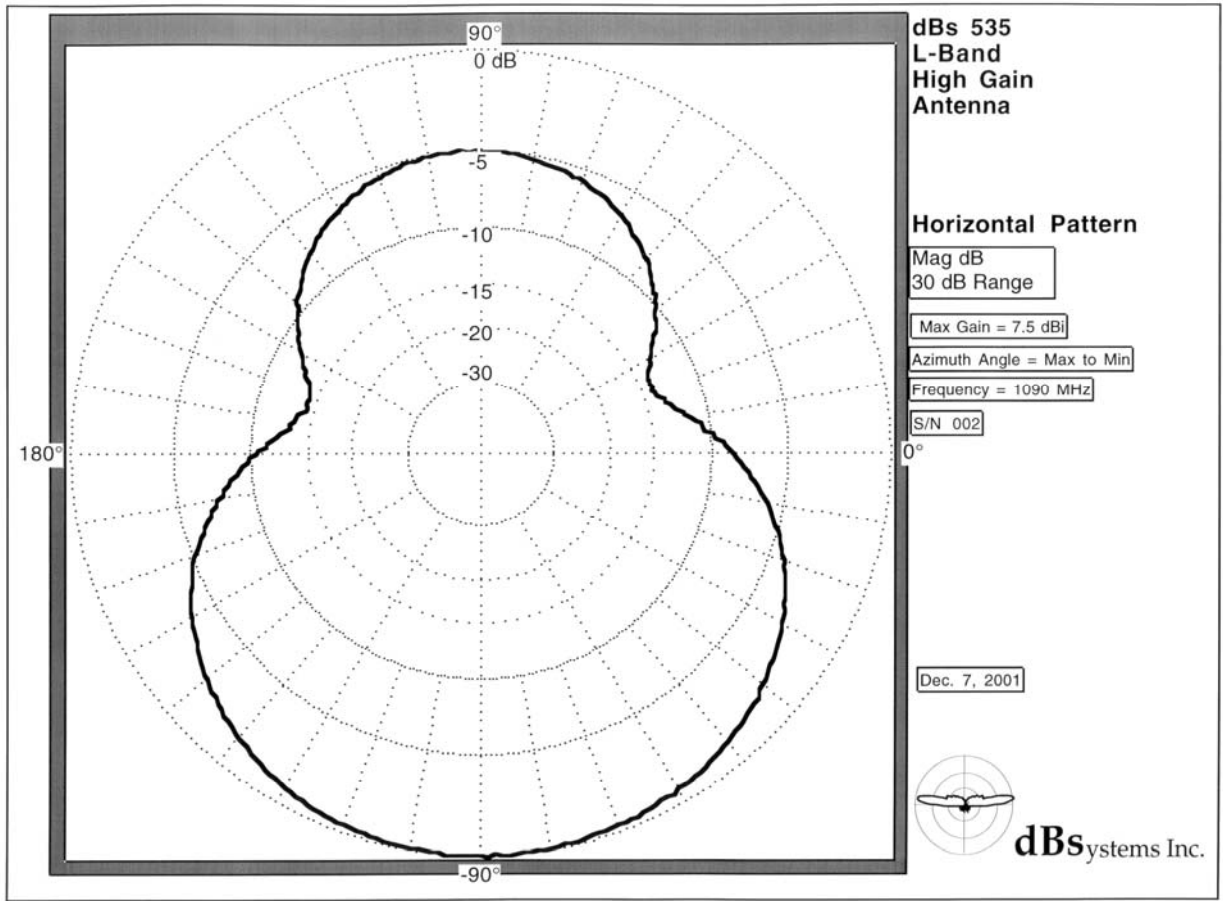

Figure H-1: L-Band Passive Gain Antenna

Figure H-2 shows a theoretical antenna that uses a pair of active driven elements to achieve directional gain while creating a uniform pattern. This antenna consists of a pair of quarter-wave resonant elements spaced at $1/8$ wavelength, and driven 45 degrees out of phase.

This antenna design achieves 6.4 dBi of gain at an elevation angle of 13 degrees, with a F/B ratio of 4 dB.

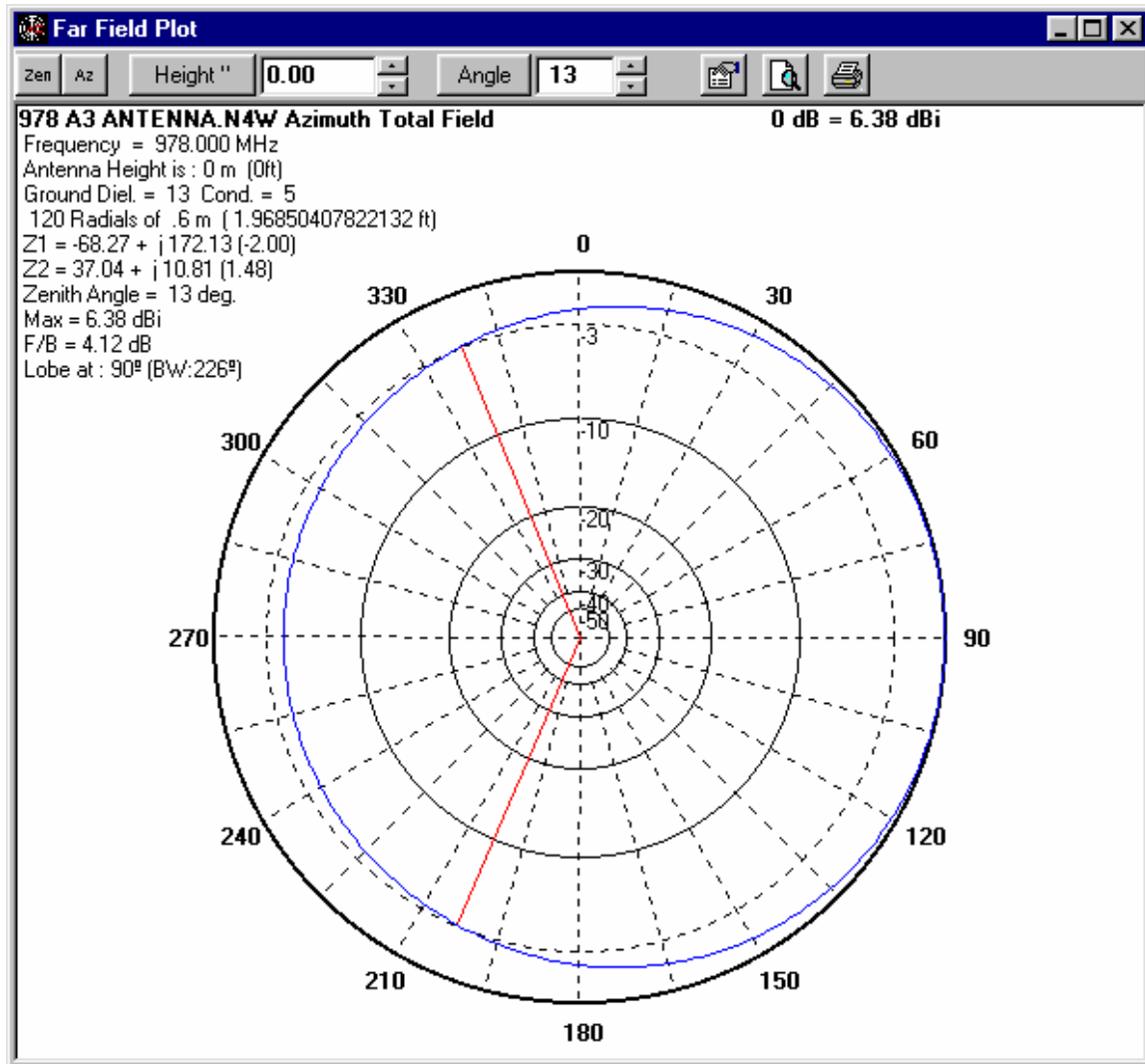

Figure H-2: Gain Array Antenna Azimuth Pattern

H.2 Typical VSWR Measurements of Existing Transponder / DME Antennas

There are several varieties of existing antennas that are suitable for use with the UAT datalink. These are summarized in Table H-1 below.

Table H-1: Typical Antennas

FAA TSO	RTCA	Equipment Type	VSWR & Frequency
TSO-C66c	DO-189C	DME	2:1 from 960-1215
TSO-C74c	DO-144	Transponder	1.5:1 on 1030, 1090
TSO-C112	DO-181C	ATCRBS Mode S	1.5:1 from 1030-1090

Typically, antennas that comply with TSO-C112 are specified with VSWR < 1.5:1 from 1030 to 1090 MHz, and VSWR < 1.7:1 over the remainder of the band from 978 to 1215 MHz. Certain types of transponder antennas that utilize very thin radiator elements are only intended for use at 1030 and 1090 MHz. These types of antennas should be evaluated on a model-by-model basis to determine their suitability as UAT datalink antennas.

Note that RF system performance is not strongly affected by VSWR values. A VSWR value as high as 2:1 does not increase the losses in the transmitted signal by more than 0.5 dB. This lack of sensitivity in system performance to VSWR values should be kept in mind when evaluating antennas for UAT applications.

The following subparagraphs illustrate these VSWR characteristics for specific antenna models. These measurements were performed with the antenna mounted in the center of a 4-foot diameter conductive ground plane.

H.2.1 Sensor Systems L Band Blade Antenna P/N S65-5366-7L

This antenna is typical of those found on jet transport aircraft, and is rated for TSO C66b, C74c, and C112. This antenna would be suitable as a UAT antenna.

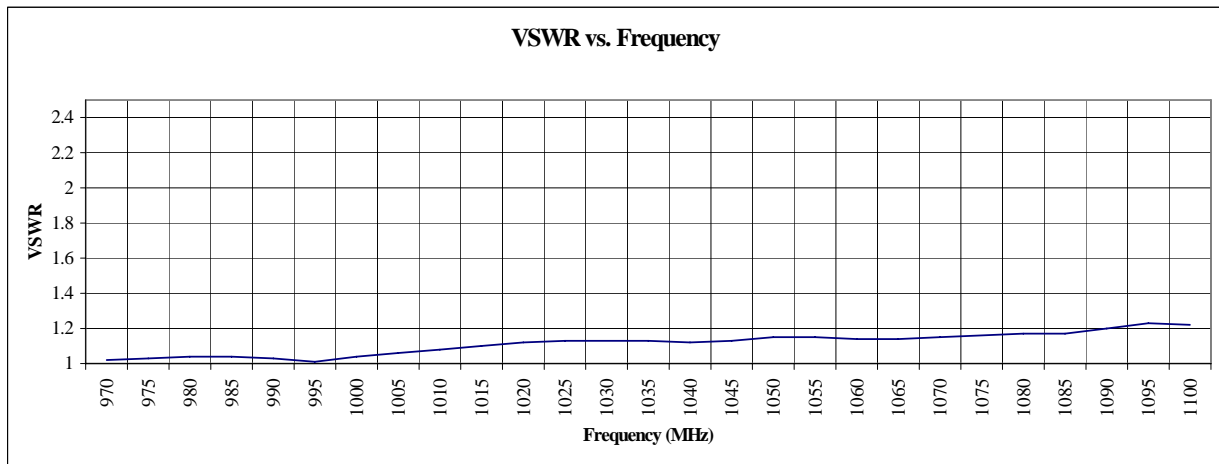

Figure H-3: Jet Transport Antenna

H.2.2 AeroAntenna P/N AT-130-1

This antenna was designed for the FAA Capstone program as a dedicated UAT antenna.

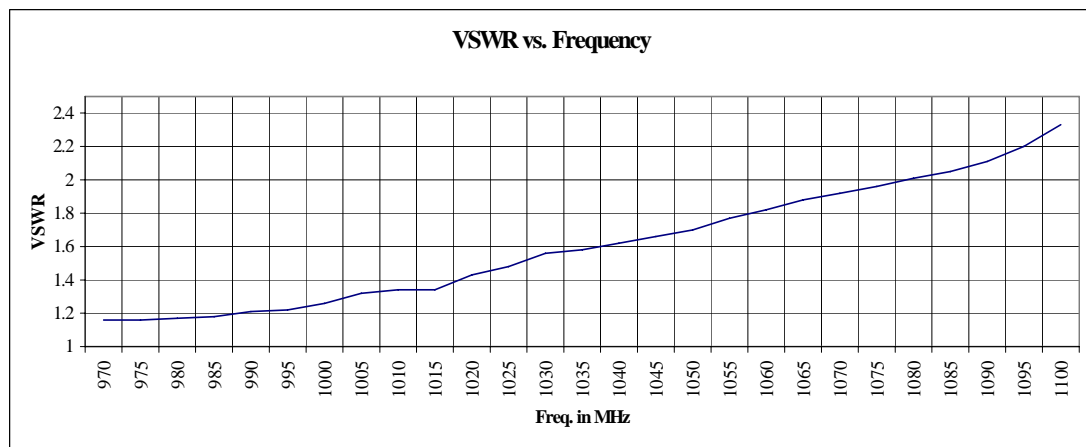

Figure H-4: Capstone Antenna

H.2.3 ¼ Wave Whip Antenna

This data represents a typical GA-application thin whip antenna, such as a RAMI Model AV-22 (TSO C-74c). Note that although not specified for performance outside of the 1030 to 1090 MHz range, it actually performs best at frequencies lower than 1030 MHz.

This antenna would be a suitable UAT datalink antenna, and illustrates the need to look at the characteristics of each candidate antenna closely.

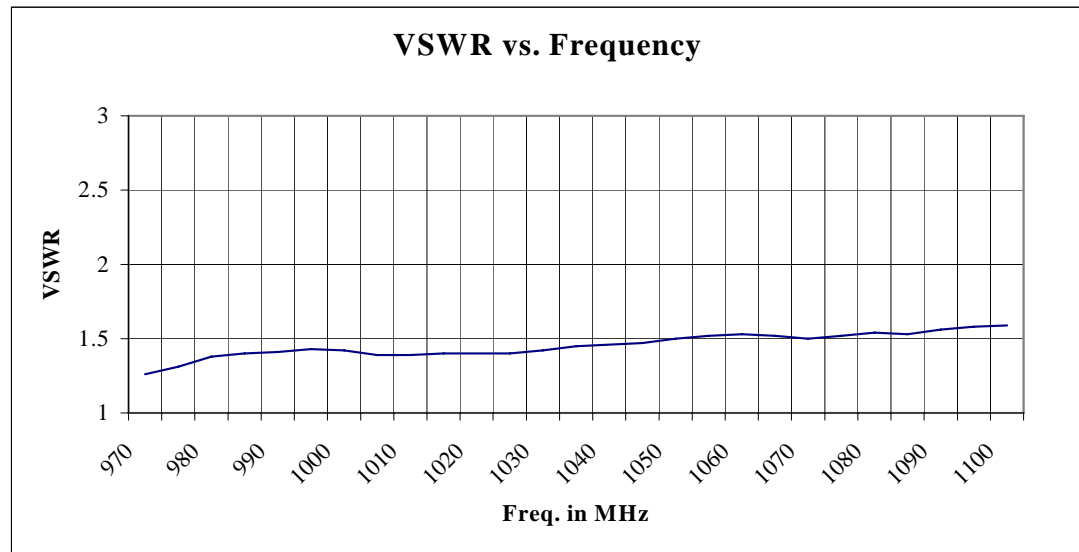

Figure H-5: ¼ Wave Whip Antenna

H.3 Passive Antenna Diplexer Characteristics

A potential method of providing an antenna for the UAT is to use a passive frequency Diplexer that is installed between an existing transponder and its antenna. Allowing the use of a Diplexer to operate UAT equipment and the on-board SSR transponder required extensive validation to verify that the use of a Diplexer would not degrade the operation of either system. A test effort utilizing a prototype Diplexer conforming to the requirements of the UAT MOPS (RTCA/DO-282A, §2.2.14.3) was utilized to conduct the necessary testing.

Upon initial investigation into the concept of antenna sharing by use of a Diplexer, certain characteristics were critical to enable use of a Diplexer. The power loss across the Diplexer was an important consideration. The typical loss that installations allow between the transponder and antenna is 3 dB. The Diplexer cannot use up a significant portion of this allocation without eliminating most existing transponder installations as candidates for UAT antenna sharing. The requirement that the Diplexer loss cannot exceed .5 dB is expected to enable most existing installations to use a Diplexer and share the transponder antenna. The goals of the Diplexer design were to support a transponder port that would minimize the insertion loss in the 1030/1090 MHz band and possessing adequate passband so that 1030 MHz interrogation signals and 1090 MHz reply signals were unaffected by the Diplexer. An optional DC path in the Diplexer's transponder channel is allowed so that installations that require antenna sensing can maintain the capability to sense the presence of an antenna. The Diplexer's transponder channel will attenuate signals at 978 MHz, providing isolation from the UAT. In some cases, Diplexer isolation actually exceeds the level of isolation obtained by using separate transponder and UAT antennas. The latter is a function of distance between antennas. The UAT's Diplexer port can provide minimal insertion loss to the antenna at 978 MHz, while manifesting a high impedance at the 1030/1090 MHz band.

H.3.1 Antenna Diplexer Testing

Tests were conducted to validate the performance of ATC transponders sharing an aircraft antenna with a UAT by incorporating a Diplexer into the installation. The purpose of the tests was to insure that both the UAT equipment and transponders perform according to the applicable standards and that the Diplexer does not introduce any signal distortions on the 978 MHz frequency of UAT and the 1030/1090 MHz frequencies of ATC transponders. A selected set of tests was performed to measure any potential degradation of equipment performance due to the Diplexer installation. The tests measured the effect of both the UAT/Diplexer on the performance of the transponder and the effect of the transponder/Diplexer on the performance of the UAT system.

H.3.1.1 SSR Transponder Testing

Tests were conducted to measure the effect of the Diplexer installation on the performance of ATC transponders. Two prototype Diplexers built by two different manufacturers were tested. Each Diplexer was tested with seven different transponders including 3 Mode S, and 4 ATCRBS only transponders.

A comprehensive set of tests were run on each transponder to measure transmitter and receiver characteristics, reply pulse characteristics, side lobe suppression, undesired replies, and pulse decoder characteristics. Each test was performed both with and without the Diplexer installed to measure the relative effects of the Diplexer. Where appropriate, with the Diplexer installation, the UAT system was connected and transmitting.

Table H-2 shows a summary of the test results. Parameters labeled “none” under measured effects showed no measurable effect within the accuracy of the test system. The test system measurement accuracy either met or exceeded the specified test conditions in the appropriate MOPS.

Table H-2: Diplexer Testing with ATC Transponders

TEST PARAMETER	MEASURED EFFECT
Reply Power	0.2 to 0.4 dB loss
Reply Frequency	None
Reply Delay (ATCRBS & Mode S)	Increased 0.01 to 0.018 microseconds
Reply Delay Jitter (ATCRBS & Mode S)	None
Reply Pulse Spacing (ATCRBS & Mode S)	None
Reply Pulse Shape (ATCRBS & Mode S)	None
Undesired Replies	UAT transmission triggered ATCRBS replies with some units
Sensitivity (ATCRBS & Mode S)	0.25 to 0.35 dB loss
Dynamic Range	None
Sensitivity Variation with Frequency	None
Bandwidth	None
Pulse Position Tolerance (ATCRBS & ATCRBS/Mode S)	None
Pulse Duration Tolerance (ATCRBS & ATCRBS/Mode S)	None
Pulse Level Tolerance P4 (ATCRBS/Mode S)	None
Sync Phase Reversal Position Tolerance (Mode S)	None
SLS Decoding (ATCRBS & ATCRBS Mode S)	None
SLS Pulse Ratio (ATCRBS & ATCRBS/Mode S)	None
Suppression Duration	None
Suppression Reinitiation	None
Recovery From Suppression	None
Mode S SLS	None
ATCRBS Desensitization Pulse and Recovery	None

The Reply Power and Receiver Sensitivity of the transponders were reduced a fraction of a dB through the Diplexer. This is expected due to the insertion loss of the transponder channel of the Diplexer that is specified to be 0.5 dB maximum. This should not be a detriment to proper operation as long as the installation accounts for the additional loss.

The reply delay showed an increase of about 10 to almost 20 nanoseconds average for all Diplexer and transponder combinations. This is an effect of the sum of the 1030 MHz interrogation and the subsequent 1090 MHz reply each being delayed through the Diplexer about 5 to 10 nanoseconds.

The Undesired reply rate was measured by monitoring ATCRBS and Mode S reply transmissions without interrogating the transponder. With the Diplexer and UAT installed and operating with the transponder, some of the transponder/Diplexer combinations resulted in unsolicited ATCRBS replies. This was caused by the low-level UAT signal leakage into the transponder channel of the Diplexer. This occurred significantly more with one of the Diplexers than with the other and it varied with the

transponder type. The worst case measured was at an average rate of about 0.75 ATCRBS per UAT transmission. There were no unsolicited Mode S replies with any of the test configurations. The undesired reply rate for ATCRBS modes is required to be 5 replies per second or less averaged over a 30 second interval. (This is the requirement for Mode S transponders – RTCA DO-181B) The MOPS for Airborne ATC Transponder Systems (RTCA DO-144) requires that the random triggering rate not exceed 30 replies per second. This latter requirement is after installation with all possible interfering equipment operating. Although the undesired reply rate caused by the UAT transmissions were within the requirements, it was not desirable to trigger transponder emissions by the UAT signal. This issue was not solely a Diplexer issue, since depending upon UAT antenna and transponder antenna proximity in an installation, UAT transmissions could cause transponder responses during UAT transmissions without a Diplexer. For this reason, UAT equipment is required to output a suppression pulse to the transponder to inhibit the transponder receiver during UAT transmissions.

Measurements also indicated that the Diplexer installation does affect VSWR. With ATCRBS transponders, the change in VSWR altered the transponder reply frequency. Mode S transponders were more immune to VSWR variations. Proper tuning of the installed cabling and adjusting for VSWR as specified in section 3.2.1.2 of this document for UAT installation, and for the transponder, as required by the applicable standard, is required.

Since the passive Diplexer integrates UAT equipment with the SSR transponder on the aircraft, it was necessary to coordinate the use of a Diplexer with the Surveillance and Conflict Resolution Systems Panel (SCRSP) of the International Civil Aviation Organization (ICAO). SCRSP produces and maintains international standards for the Mode S and SSR systems. The results of the extensive tests that were conducted to verify proper operation of the SSR transponder with a passive Diplexer were made available to SCRSP to evaluate the performance of the SSR transponder through the Diplexer.

An additional set of tests were recommended by SCRSP to investigate the performance of a Mode S transponder with the use of a Diplexer and its ability to properly decode Mode S interrogations with numerous Differential Phase Shift Keying (DPSK) phase shifts. These tests would verify that the bandwidth of the Diplexer does not cause distortion of the interrogation signal that would degrade the ability of the Mode S transponder receiver to properly decode these interrogations. In order to evaluate the Diplexer impact on DPSK, the transponder receiver sensitivity was tested as interrogation frequency was varied. Three Mode S type transponders were tested both with and without the Diplexer installed in order to make a direct comparison of the Diplexers effect. The transponders tested were from three different manufacturers. The installation of the Diplexer affects the Voltage Standing Wave Ratio (VSWR) of the antenna ports, so a slotted line and stub tuner were used to monitor and control VSWR. The stub tuner was used to set the VSWR to the same minimum value obtainable with and without the Diplexer. This was done to minimize the VSWR influence on the sensitivity measurements.

Figure H-6 shows a plot of the Sensitivity Variation with Frequency measurements for one of the transponders tested. The interrogation consisted of a legal uplink format defined by the first five bits of the interrogation. All other data bits equal to binary '1' except the Address Parity (AP) field, which was properly coded to elicit a response from the transponder. The all binary 1's format was used to maximize the number of phase shifts in the uplink interrogation. This was the primary interrogation format used to test all three transponders.

The data shows a consistent average reduction in sensitivity of about 0.2 dBm, the loss through the Diplexer, which does not vary significantly with frequency. Additional tests were conducted with all variable data bits equal to binary '0' to minimize the number of phase shifts with nearly identical results.

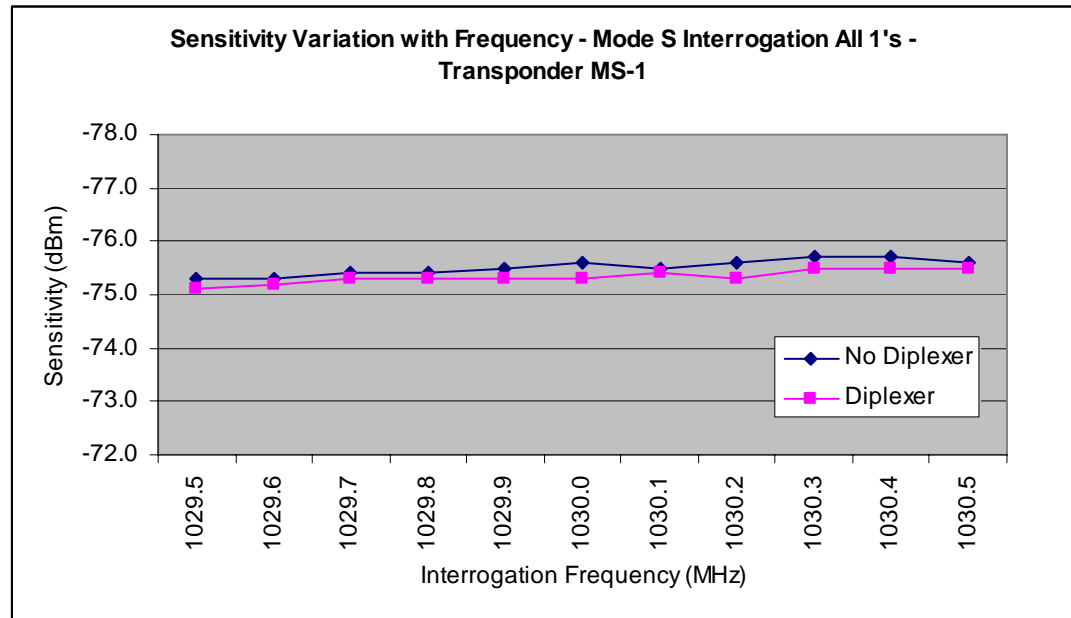

Figure H-6: Sensitivity Variation with Frequency, All 1's Interrogation, Transponder MS-1

All three tested Mode S transponders yielded similar results. The conclusion from running these tests is that other than the expected reduction in the transponder receiver sensitivity from the loss across the Diplexer, the Mode S sensitivity is not affected as a function of frequency within the operating bandwidth of the transponders. The Diplexer bandwidth characteristics for the SSR transponder channel adequately handles 1030 MHz Mode S interrogation signals with excessive DPSK phase variations.

H.3.1.2 UAT Diplexer Testing

A variety of tests were conducted to determine the effects of UAT signals through a Diplexer. Testing was facilitated using nine different configurations to test various combinations of remote or onboard UAT receivers, remote Ground Uplink transmissions, interference to UAT from remote or onboard Mode S or ATCRBS transponders, as well as onboard transponder leakage, in circuit with an implemented antenna Diplexer.

Since no performance difference was measured looking at UAT reception at the on-board UAT receiver nor remotely when looking at UAT signals from the on-board transmitter through the Diplexer, the severe case of onboard interference from Mode S or ATCRBS transmissions through the transponder port of a Diplexer to a UAT receiver, was investigated. Even though the assumptions for the UAT performance model assume no UAT receptions when UAT signals are overlapped by on-board SSR transmissions, the test results show that the Diplexer provides sufficient isolation from the on-board 1030 MHz and 1090 MHz transmissions to enable a high probability of successful reception of

low-level UAT messages. In all of the test cases where Mode S or ATCRBS transmissions interfered with UAT message receptions, the test was particularly severe. The transponder transmissions were overlaid in time with the UAT messages 100 % of the time, yet the UAT receiver, isolated by the antenna Diplexer, performed with no significant degradation

H.3.1.3 Prototype Diplexer Performance

The following figures show measured data obtained from a prototype L-band Diplexer.

Figure H-7 shows the performance between the Antenna and UAT ports.

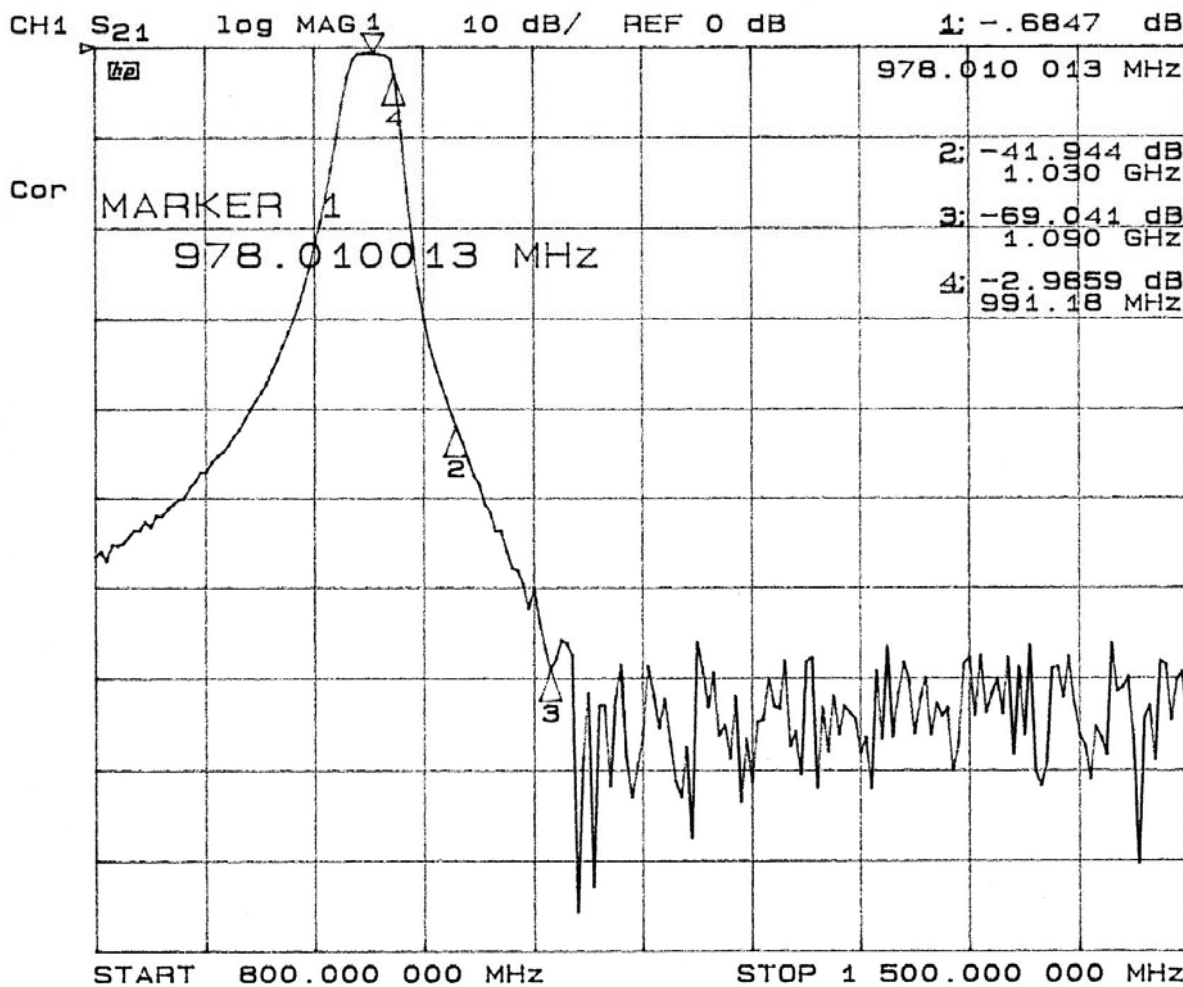

Figure H-7: Diplexer UAT Port

Figure H-8 shows the performance between the Antenna and Transponder ports.

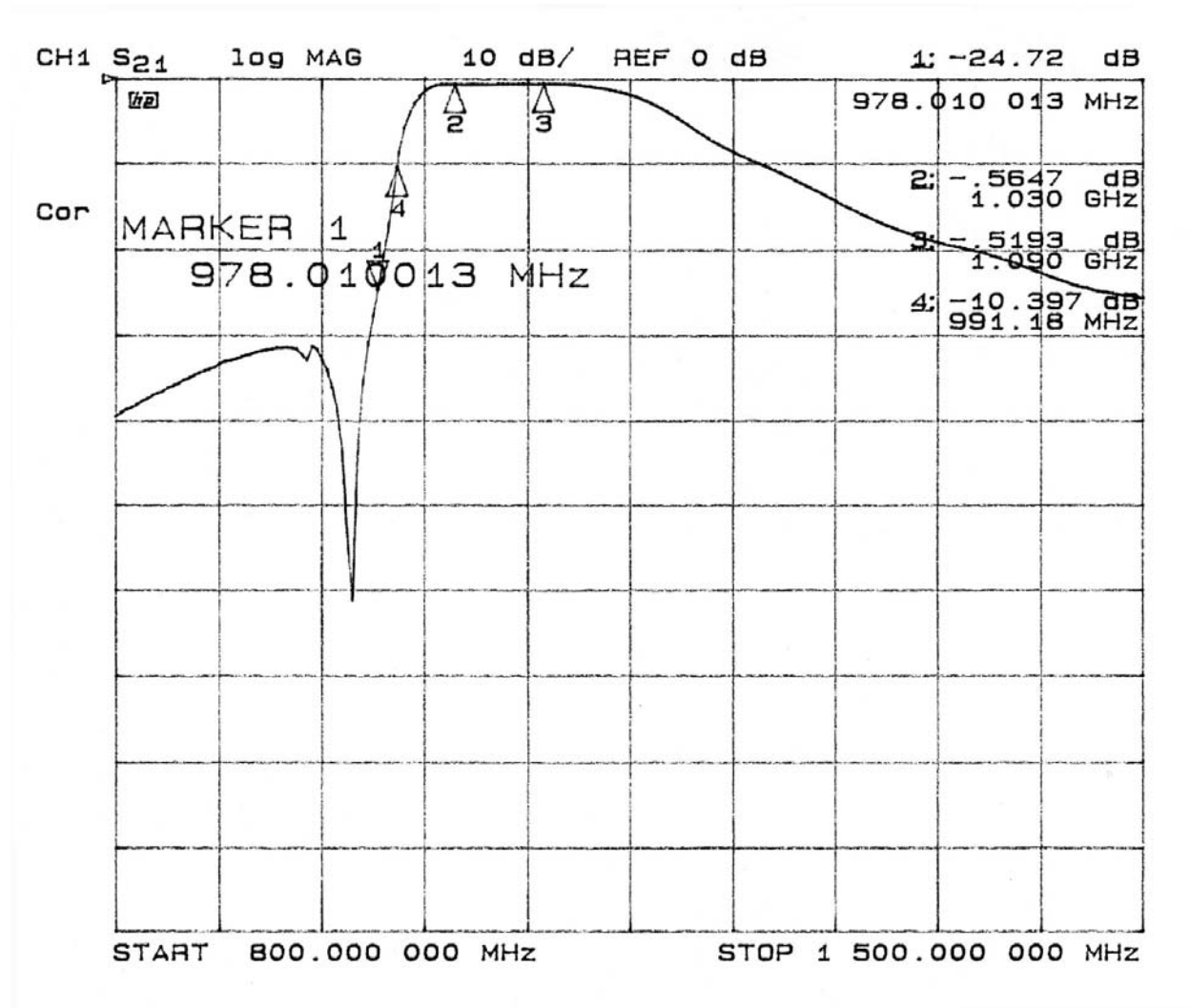

Figure H-8: Diplexer Transponder Port

Figure H-9 shows the isolation between the UAT and Transponder ports. Note that the isolation between the ports at the UAT frequency is 25 dB, and the isolation at the Transponder frequencies are 42 dB at 1030 MHz, and 64 dB at 1090 MHz.

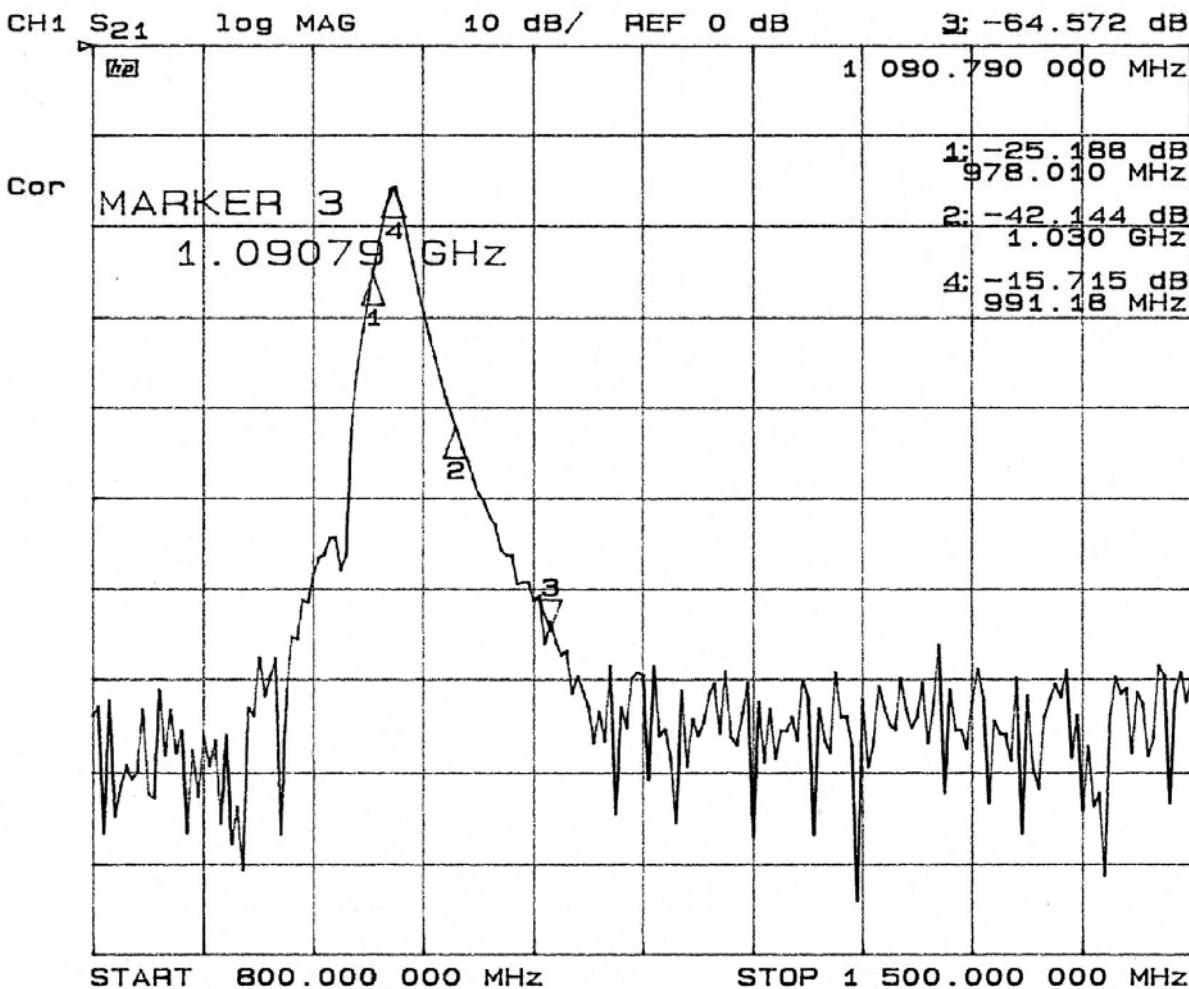

Figure H-9: Diplexer UAT-to-Transponder Port Isolation

H.3.2 Typical Installation Diagram

Figure H-10 illustrates how a UAT might be added to a typical existing transponder installation by using frequency Diplexer/combiner. Shaded boxes indicate the new components added to the existing installation. The Diplexer can be added anywhere in the antenna's feedline. The most logical place for this addition would be in the aircraft's equipment bay in close proximity to both the UAT and transponder units. This way, existing feedlines would not have to be re-routed or altered.

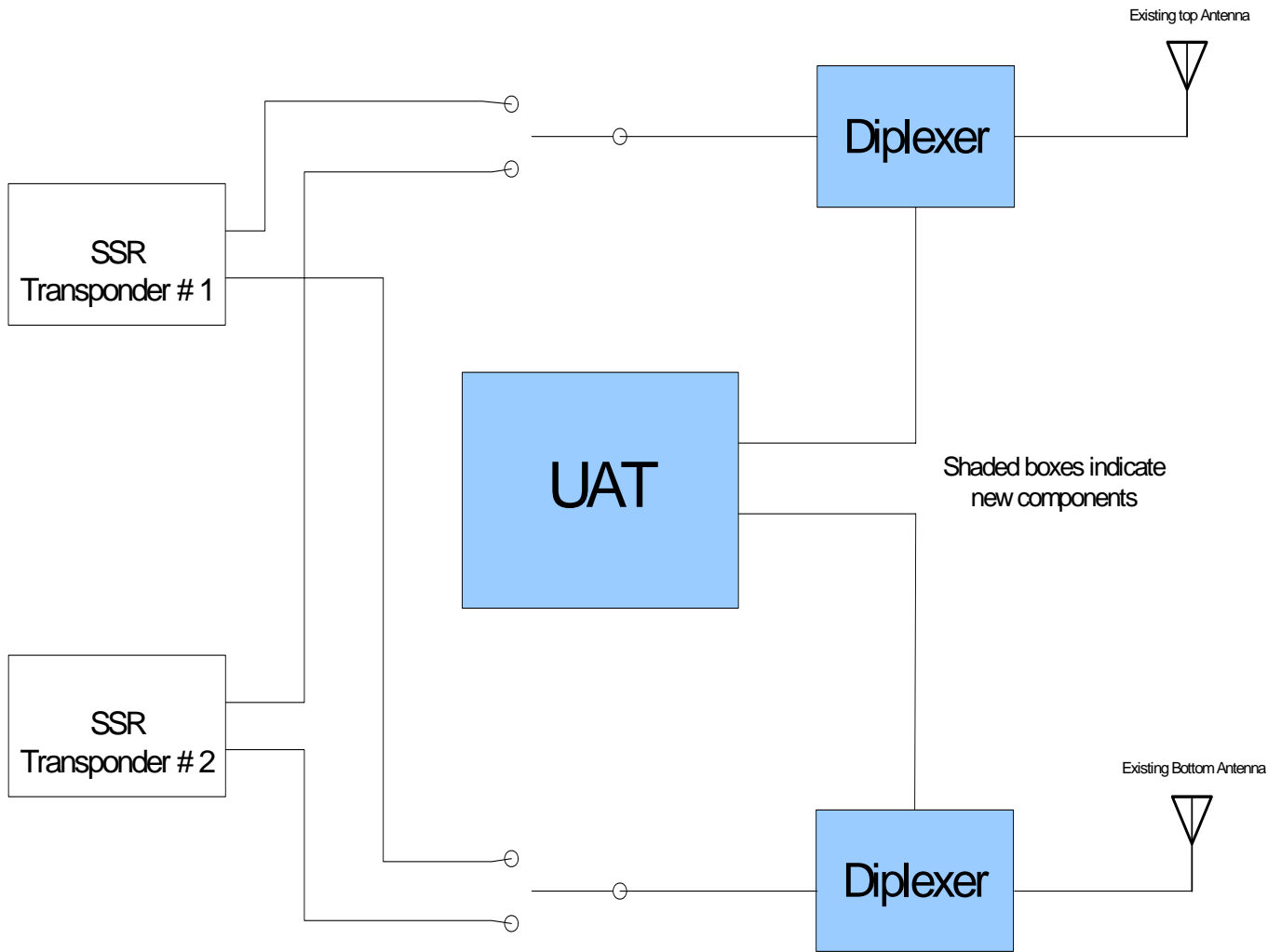

Figure H-10: Diplexer Installation

Appendix I

Simulated Results for Delivery of Four Trajectory Change Reports over UAT in Core Europe 2015

This page intentionally left blank.

I. Simulated Results for Delivery of Four Trajectory Change Reports over UAT in Core Europe 2015

I.1 Introduction

The use of ADS-B for exchange of intent information has been viewed as a possibility that could enable long-range airborne applications, such as conflict detection and avoidance. The RTCA ADS-B MASPS (DO-242A) outlines some guidelines for transmission of some intent information, but does not specify requirements for the transmission of Trajectory Change Reports (TCRs). The current RTCA UAT MOPS (DO-282A) discusses the transmission of two TCRs. This Appendix contains a description of how up to four (4) TCRs may be supported by the UAT system. The purpose is to examine the performance of several potential schemes for transmission of multiple TCRs over UAT, with the intention of facilitating future discussions of broadcasting intent over UAT.

Three paths for different transmission schemes for A3-equipped aircraft were proposed for consideration:

1. Changing the current four-second transmission epoch to five seconds, with four TCR messages plus a Mode Status message;
2. Maintaining the four-second epoch, which currently results in a total of twelve TCR transmissions in sixteen seconds (eight TC0 and four TC1), and modifying the current TCR transmission schedule to cycle through 3 or 4 different TCRs; and, finally,
3. Re-definition of the TCR information, to determine whether the actual data requirements would be less than those currently suggested by RTCA, leading to the possibility of including two TCRs in a single ADS-B message. This last course was not carried out for this analysis.

The results of the analysis using the first two techniques will each be described in more detail in the sections below.

I.2 Intent Results Using Four-Second Epoch

Currently, the A3 equipage level transmission schedule, as outlined in the UAT Technical Manual, section 2.1.3 and in section 3.1.1 of this Manual, specifies that the four-message sequence consists of:

- Message type 1, which contains no intent information
- Two message type 4, which can contain TC+0, the next Trajectory Change Point for the aircraft
- Message type 5, which can contain TC+1, a second Trajectory Change Point for the aircraft to be reached after TC+0

These messages are to be transmitted in the following sequence, over the course of 16 seconds, as indicated in section 3.1.2 of this Manual:

1-4-4-5-5-1-4-4-4-5-1-4-4-4-5-1.

This is done in order to ensure that each message is transmitted and received from both top and bottom antennas in a uniform manner.

The analysis in this section makes use of the sixteen-message sequence listed above, with the message types 4 and 5 replaced by “any intent message”, so that the sequence becomes:

1-N-N-N-N-1-N-N-N-N-1-N-N-N-N-1,

with N representing a message containing the information for a Trajectory Change Report, with N=4 (TC+0), 5 (TC+1), 7 (TC+2), or 8 (TC+3). Intent Messages to be transmitted are cycled in order. This means that for four TC transmissions, the scheduler cycles through 4-5-7-8 as it reaches each N message, while for three TCs, it cycles through 4-5-7. This scheme results in three of each TC being transmitted every 16 seconds for the four TC case, and four of each TC going out every 16 seconds for the three TC case.

The Multi-Aircraft UAT Simulation (MAUS) was run to assess received TCR performance for these two cases, and the results are summarized in Figure I-1 below.

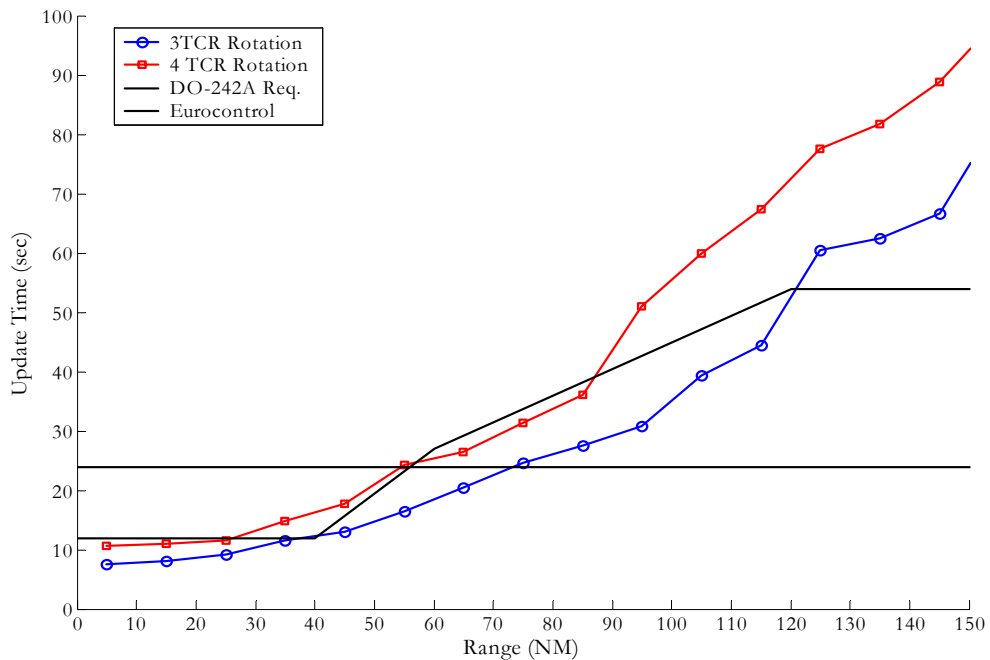

Figure I-1: 95th Percentile Trajectory Change Report Update Times for an A3 Receiver at High Altitude in CE 2015 over Brussels Using TC Rotation to Deliver Messages Containing Information for 3 or 4 TCRs

These simulation runs were made for an A3 receiver over Brussels (in the Core Europe 2015 air traffic scenario with all aircraft equipped with UAT and including JTIDS and DME interference) receiving A3 intent transmissions. Since each TC is transmitted in the same pattern, the data were accumulated to show the TC 95th percentile update time for receiving any of the four TCRs as a function of range. The dashed line represents guidance on desired TCR reception provided by Eurocontrol, while the solid line is the requirement of the RTCA/DO-242A, ADS-B MASPS, for the TCR containing the TC+0 information.

As expected, the three-TC case performs better than the four-TC case, since each message is transmitted more frequently when only three TCs are used. It should be noted that no attempt has been made to optimize TC transmissions.

I.3 Intent Results Using Five Second Epoch

The MAUS was modified to allow for a five-second epoch for transmissions from aircraft equipped with Class A3 UAT avionics, defined with the following sequence:

1-4-5-7-8,

repeated continuously.

A set of MAUS runs was made using this modified version with the exact same air traffic scenario as described in the previous section: A3 reception of A3 intent information, over Brussels in the same interference conditions. The results are presented in Figure I-2 below.

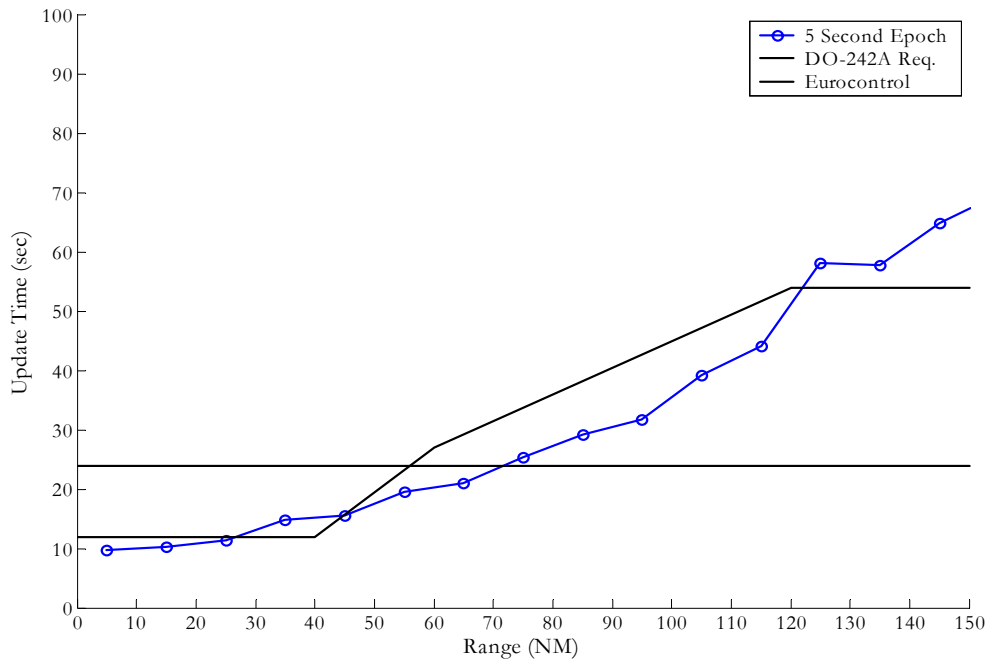

Figure I-2: 95th Percentile Trajectory Change Report Update Times for an A3 Receiver at High Altitude in CE 2015 over Brussels Using a 5 Second Epoch to Deliver 4 TC Messages

As in the previous section, these results show the TC 95th percentile update time for receiving any of the four TCRs as a function of range. The dashed line represents the guidance received from Eurocontrol on the desired update rate, while the solid line is the requirement of the RTCA/DO-242A ADS-B MASPS for the TCR containing information on TC+0.

Figure I-3 compares the performance of the two techniques outlined here for the transmission of four TC messages over UAT. Once again, it should be noted that these results represent only an initial attempt to accommodate four TC transmissions. No effort has been made to improve or optimize the techniques used. In addition, reception of intent information by a receiver on the ground has not been studied.

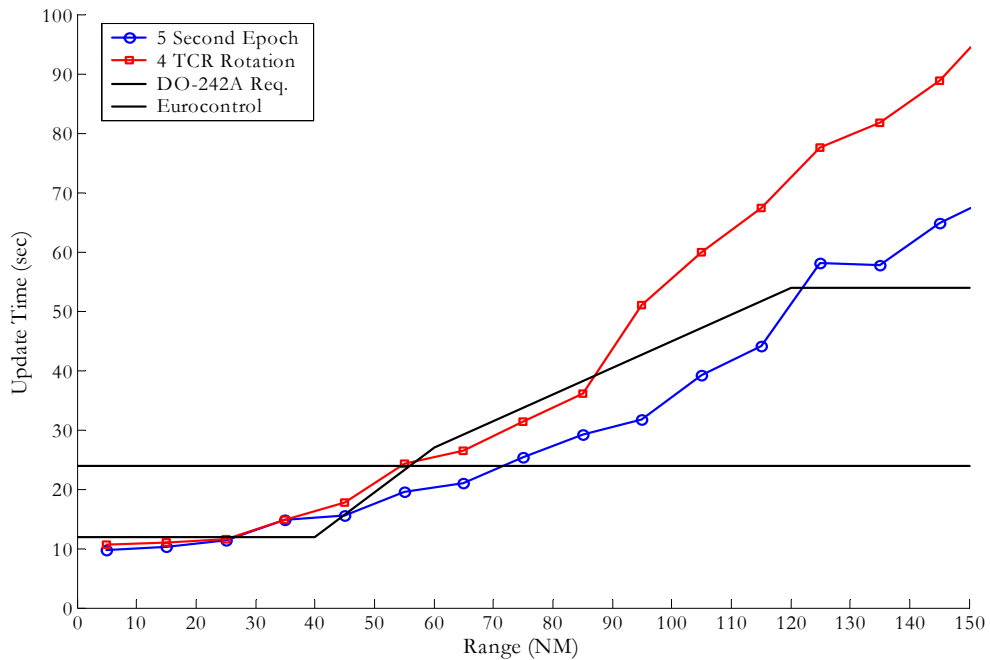

Figure I-3: 95th Percentile Target Change Report Update Times for an A3 Receiver at High Altitude in CE 2015 over Brussels Comparing Both Methods for Delivering 4 TC Messages

From Figure I-3, it appears that as defined for this analysis, the 5-second epoch technique used produces better results than that used with the 4-second epoch. This might have been anticipated, since the 5-second epoch results in three repetitions of each TCR every 15 seconds, while the 4-second epoch supplies three copies of each TCR every 16 seconds. These results supply a rough guideline for comparing the two techniques. It should be noted that the use of the five-second epoch results in the transmission of Mode Status information, once every five seconds instead of once every four seconds. The operational impact, if any, of this difference has not been evaluated.

This page intentionally left blank.

Appendix J

UAT Ground Station Data Channel Assignment Guidance

This page intentionally left blank.

J. UAT Ground Station Data Channel Assignment Guidance

J.1 Introduction

The appendix describes one method that could be used to coordinate the assignment of uplink resources from UAT ground stations within a region. In developing this assignment method, the guiding operational objective was limited to providing a user with connectivity to at least one ground station at any point within the combined service area of the network. Additionally, it is assumed this one ground station need not be any particular ground station – each ground station will transmit products of interest to any user likely to receive them. Finally, this assignment method relies on horizon blockage of the undesired signal rather than relying on a specific Desired to Undesired (D/U) signal ratio.

In order to maximize the volume of airspace within which aircraft equipped with UAT receivers can receive up-linked information from Ground Stations (GS), the locations of the GS must be carefully chosen. In addition, the service volume depends critically on the way the ground up-link segment resources (32 Data Channels) are distributed among the GS. One or more Data Channels assigned to a UAT Ground Station is called the station's "Data Channel Block" (DCB). The reason this maximization is not trivial is that there are two conflicting criteria that must be satisfied. In order to provide low-level coverage, GS must be spaced closely together due to line-of-sight (LOS) considerations. On the other hand, aircraft at high altitudes will see many of the closely-spaced GS. Thus, in order to avoid unwanted interference, all the GS within view of a particular aircraft should, to the degree possible, use separate DCBs. This means that if a wide range of altitudes is to be supported, there may need to be many different DCBs. However, the number of such sets is very limited. Assume, for the moment, that each GS has four Data Channels' worth of information to transmit each second (see §J.2.2 for a discussion of unequal DCBs). In that case, there will be only 8 DCBs. In what follows it will be shown that the way these DCBs are assigned to the GS can have a profound impact on the overall system performance.

In the §J.2, an ideal case where the Earth is assumed to be a smooth sphere and where ground sites can be freely chosen to be on a nearly perfect hexagonal grid will be considered. In §J.3 a more realistic approach is considered, where siting is constrained and terrain effects come into play.

J.2 Ideal Case

There are well-known rules for assigning resources on a hexagonal grid. Normally, the resource is a frequency assignment, but in this case it is a DCB assignment. The rules are the same. There are certain allowable patterns such as the 7-fold pattern commonly used in cellular telephone systems. All the patterns employ a number of separate resources given by:

$$N = m^2 + mn + n^2$$

where m and n are any two nonnegative integers. Below, the focus will be on patterns with N=3, N=4, and N=7. Each pattern will be referred to by its value of N. For instance pattern (7) corresponds to m = 2 and n = 1.

Figure J-1 shows pattern (4). (Only part of the grid is filled out. The remainder should be obvious.) The DCB assignments are labeled A, B, C and D. Note that two of the A cells have been singled out by coloring them red and blue. These two have the potential to interfere with one another; however, if the distances and altitudes are such that the radio horizon of the blue cell (shown as the blue circle) lies entirely outside the red cell, it will not materially interfere with reception from the red ground site within the red cell. If the intersite distance is D, then the radius of the blue circle is $3D/2$, and the radius of the red circle is $D/\sqrt{3}$. These two radii can be related to the highest altitude (service ceiling) of the cells that provides no interference and the lowest altitude of the cells that has complete coverage (service floor). These are given by:

$$\frac{3D}{2} = 1.23\sqrt{H_c}$$

$$\frac{D}{\sqrt{3}} = 1.23\sqrt{H_f}$$

with H given in feet and D given in nautical miles. In this case the ratio of the service ceiling to the service floor is just:

$$\frac{H_c}{H_f} = \frac{27}{4}.$$

Thus, if the service ceiling height were 54000 feet, the service floor would be at 8000 feet.

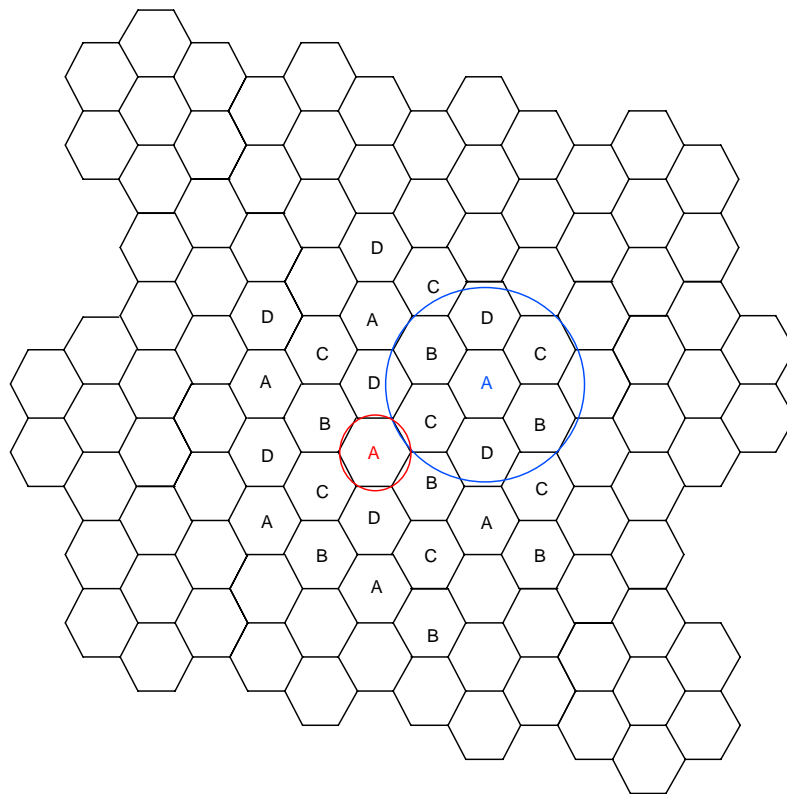

Figure J-1: Basic Pattern (4)

A similar analysis for pattern (7) shows that the ratio of service ceiling to service floor would be 13. For example, if the service ceiling were 39000 feet the service floor would be 3000 feet. This may appear to be the limit of service floor/ceiling performance given the restriction to no more than 8 DCBs; however, there is a way to extend this range by adopting a tiered approach.

Suppose, for example, that there is an array of widely-spaced GS in pattern (4) to cover an upper tier (Tier 1) from 54000 feet to 8000 feet (as above). A second set of sites that are more closely spaced can then be used to fill in the low-level gaps in coverage provided by the first set. The second layer of coverage is called Tier 2. If Tier 2 is also laid out in pattern (4), the result may appear as shown in Figure J-2. This pattern is designated pattern (4, 4). The sites supporting Tier 1 are given upper case letters, and the sites supporting Tier 2 are given lower case letters¹. Note that only the letters a, b and c are used in Figure J-2, making it appear as though this would be more correctly called a pattern (4,3). However an important point is that sites that support Tier 1 also support Tier 2. In other words, if we replace the upper case letters with the letter “d”, the result is pattern (4). The fact that the potential “d” sites employ 4 *different* DCBs will only lower the possibility of interference between them (below the lowered service ceiling of Tier 2). (See §J.2.1 for further explanation.)

¹ To this point DCBs have been consistently referred to using only capital letters. Within the remainder of this appendix the concept of groups of DCBs (each oriented to altitude tiers) is developed. To clearly delineate each of these groups, capital letter, small letters and numbers are all used to represent DCBs belonging to three groups (tiers).

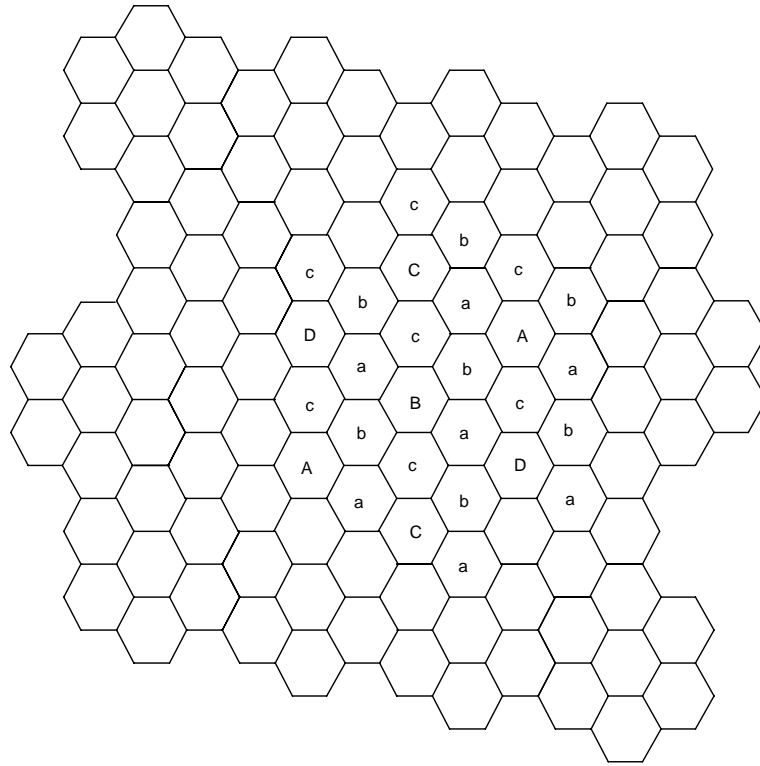

Figure J-2: The (4, 4) Pattern for Tiers 1 & 2

Note: *The tier 1 cells (capital letters) serve double duty; they also form the fourth DCB of tier 2. Thus the designation as Pattern (4,4)*

If we let D_1 be the intersite spacing of the Tier 1 cells and D_2 be the intersite spacing of the Tier 2 cells, then

$$D_2 = D_1/2.$$

It is critical to note that the service ceiling of the Tier 2 sites is 13500 feet and the service floor is at 2000 feet. Because the service floor of Tier 1 is lower than the service ceiling of Tier 2, there are no gaps in coverage. Also, the total range of altitudes covered is larger than the range provided by the single-tiered approach using pattern (7).

An exhaustive search of all the possible tiered patterns using no more than 8 DCBs shows that the best GS layout is given by the three-tiered array designated as pattern (4, 3, 3). This uses all 8 available DCBs. (Recall that each of the lower tiers uses only two additional DCBs.) If the spacing between the closest sites is 60.25 NM, the pattern provides gapless coverage for all altitudes from 800 feet to 48600 feet (a ratio of 60.75).

J.2.1 Alternative View of Ideal Case

In the previous section, a top-down description of the proposed patten (4, 3, 3) was provided. It may be instructive to include a description from the bottom up. Figure J-3 shows a standard set of pattern (3) hexagons labeled 1, 2 and 3. These will constitute the Tier 3 sites. If they are separated by 60.25 NM they will provide coverage from 800 feet to 3200 feet.

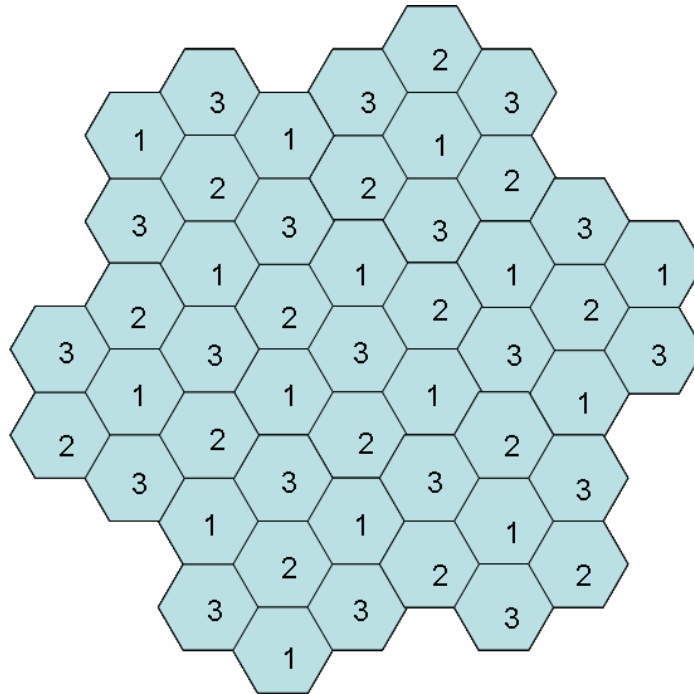

Figure J-3: Tier 3 of Pattern (4, 3, 3)

For coverage above 3200', the sites labeled 3 in Figure J-3 are relabeled as a, b or c as shown in Figure J-4. These Tier 2 sites are separated by 104.35 NM and provide coverage from 2400 feet to 9600 feet.

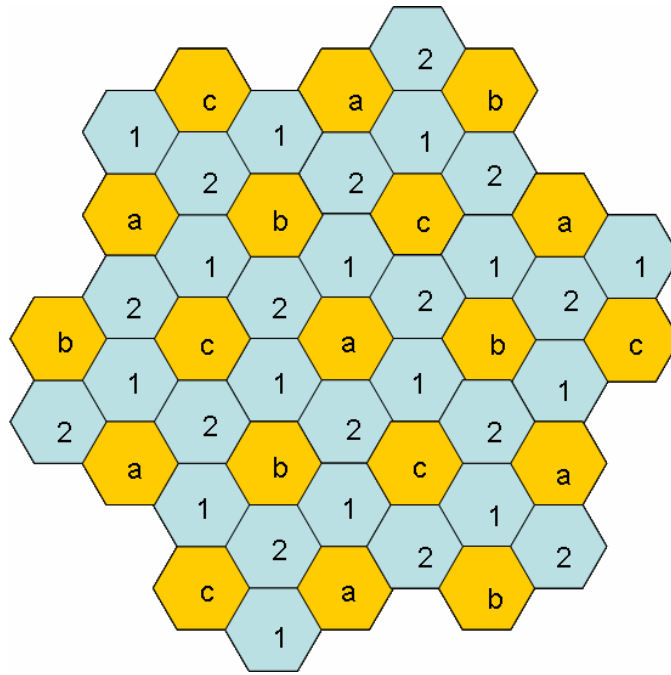

Figure J-4: Tiers 2 and 3 of Pattern (4, 3, 3)

Finally, Tier 1 is constructed by relabeling the Tier 2 sites labeled c with A, B, C or D to give Figure J-5. These Tier 1 sites are separated by 180.75 NM and provide coverage from 7200 feet to 48600 feet. Figure J-6 illustrates the general shape of the effective service volumes of cells from each tier.

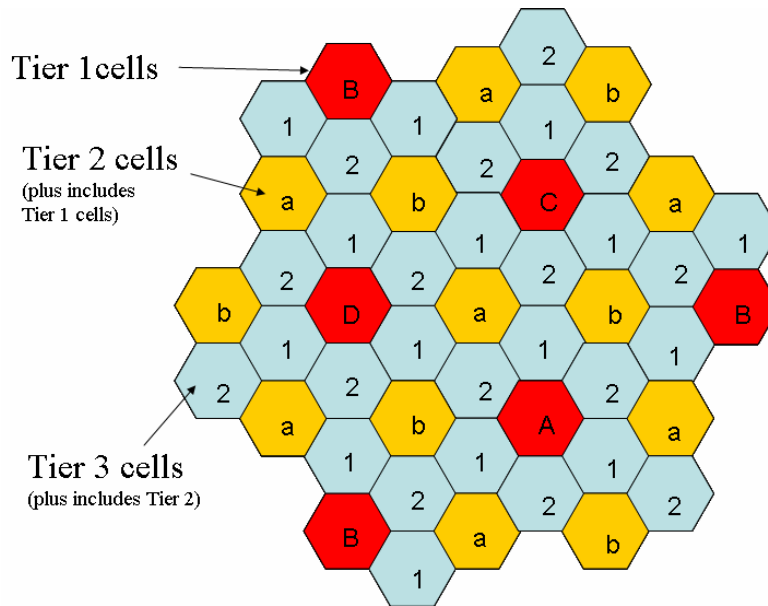

Figure J-5: Complete Pattern (4, 3, 3)

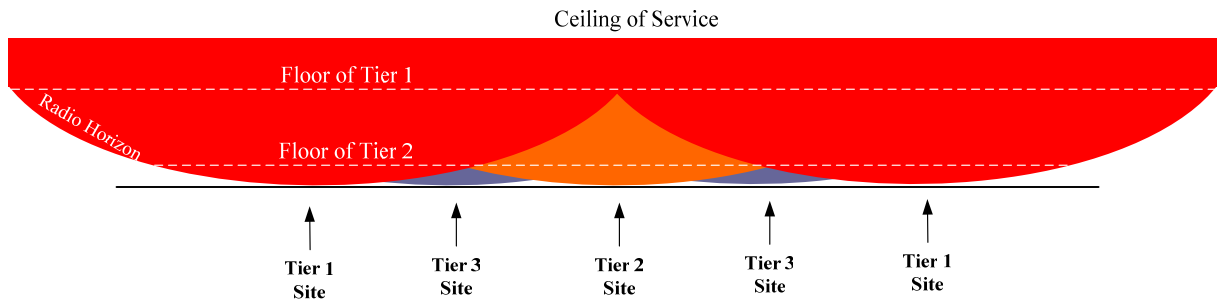

Figure J-6: Conceptual View of Uplink Service Volume in Cross Section

J.2.2 Alternative DCB Assignments

Up to this point it has been assumed that the DCBs assigned to the different ground sites all have the same capacity, i.e., they all consist of 4 Data Channels. However, it seems likely that the sites servicing the larger volumes (the higher tiers) will have more information to convey. Thus, it may be advantageous to assign the capacity unevenly. For example, for the pattern (4, 3, 3) the numbers of Data Channels assigned per site might be 5, 4 and 2 (going from Tier 1 to Tier 3). If that were the case, then the total number of Data Channels assigned would be $5 \times 4 + 4 \times 2 + 2 \times 2 = 32$; all the Data Channels would be assigned to one type of site or another.

In the original case where each DCB consists of 4 Data Channels. The Data Channels assigned to each DCB can always be allocated to GS so that in each second individual GS can transmit on a schedule with evenly-spaced transmissions 8 Data Channels apart. This will ease the up-link transmitter design by keeping the short-term duty factor low. However, for the 5-4-2 plan described in the previous paragraph, this is not possible. For this Data Channel usage plan the following schedule ensures that successive transmissions from any GS are no closer than 6 Data Channels. (Data Channels are numbered from 1 to 32.) Of course, the actual slots are rotated on a second-by-second basis according the rules of section §3.2.2.2 of the UAT Manual on Detailed Technical Specifications.

Table J-1: Data Channel Mapping to DCB for the 5-4-2 Plan

DCB	Data Channel
1	1,17
2	9,25
a	3,11,19,27
b	7,15,23,31
A	5,12,18,24,30
B	2,8,14,21,28
C	4,10,16,22,29
D	6,13,20,26,32

J.3 Deployment Example

In an actual deployment, site selection for UAT will tend to be limited to ground locations that are already available to the service provider. Also, varying terrain may

enhance radio line-of-sight range (LOS) if a site is at a high elevation or limit it if a site is surrounded by mountains, for example. Thus, the coverage of the ground sites will be anything but regular, and a perfect cellular layout will not be possible. Nevertheless, it seems that the method of providing a tiered approach may still be a good one. The question is how to most efficiently construct the tiers.

Important parameters that will determine the solution of the Data Channel assignment problem are the desired service ceiling and service floor altitudes. The achievable service floor is largely determined by the intersite spacing. If the spacing between any two sites is large, the bottom of the coverage between them will be high. To achieve a low service floor will require close spacing. That, in turn, may require a large number of ground sites to cover a given geographical region. Of course, low level coverage may only be necessary in selected locations, so the number of sites could be reduced. On the other hand, the effects of terrain variation may increase the number of sites needed.

One strategy for Data Channel assignment would be to begin with all the available sites and attempt to create Tier 1. An initial site for assignment of DCB "A" could be chosen near the edge of the overall coverage area, and then a second site could be chosen such that its LOS did not impinge upon the desired service volume of the initial site and the LOS of the initial site did not impinge upon the desired service volume of the second site. To do this it is necessary to define what is meant by the "desired service volume" of a site. That depends on the ideal pattern being approximated. Suppose it is pattern (4, 3, 3). If the target Tier 3 intersite distance, D_3 , is taken to be 60.25 NM (as in §J2), then the next reuse of DCB "A" would be about $2D_1 = 6D_3 = 361$ NM away, and the desired LOS would be somewhere between $D_1/2 = 90$ NM and $D_1/\sqrt{3} = 104$ NM. Choose the closest site that meets the noninterference criteria. The next site to use DCB "A" should be the one of the remaining sites that is closest to the first two and also obeys the noninterference criteria. In this case "closest" could mean the one for which the sum of the distances to the two nearest sites using DCB "A" is the least. This process should continue until no more DCB "A" sites can be assigned. This process should then be repeated using B, C and D DCBs. When choosing these sites, care should be taken to pick locations that most closely approximate the desired hexagonal effect. If all goes well, this process will provide total coverage from 48600 feet down to an altitude below the service ceiling of Tier 2. Tier 2 can now be populated using a similar method. For selected locations that need particularly low altitude coverage, Tier 3 locations can also be identified using similar techniques.

J.3.1 An Implementation Example

The process described in the previous plan has been used on a limited basis to make DCB assignments for a deployment of 30 GS in the southeastern part of the United States. Using the top-down approach it was relatively easy to define the Tier 1 sites with the proper spacing. The Tier 2 sites were more difficult to define since the available sites were not evenly distributed geographically. It was nearly impossible to assign Tier 3 sites according to the rule of the ideal model. These were assigned on a more *ad hoc* basis by trying to maximize the distance between any two sites using the same slot set, independent of their relation to the pattern of the top two tiers. The performance of the resulting assignment plan can be judged by observing the coverage at altitudes of 40000 feet, 10000 feet and 3000 feet shown in Figure J-7, Figure J-8 and Figure J-9. The shaded portions denote areas with coverage by at least one GS. Note that at the highest altitude the coverage is determined with respect to altitude Above Mean Sea Level (AMSL), while the coverage at the lower two altitudes was Above Ground Level (AGL).

In these figures terrain effects have been taken into account, which explains the sometimes irregular shapes of the individual service volumes.

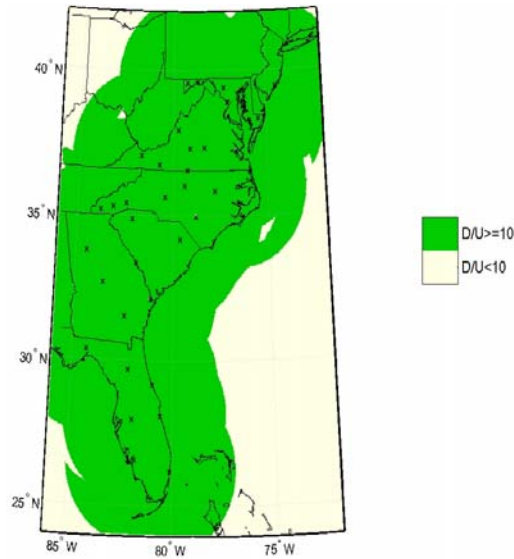

Figure J-7: USA East Coast Coverage at 40000' AMSL

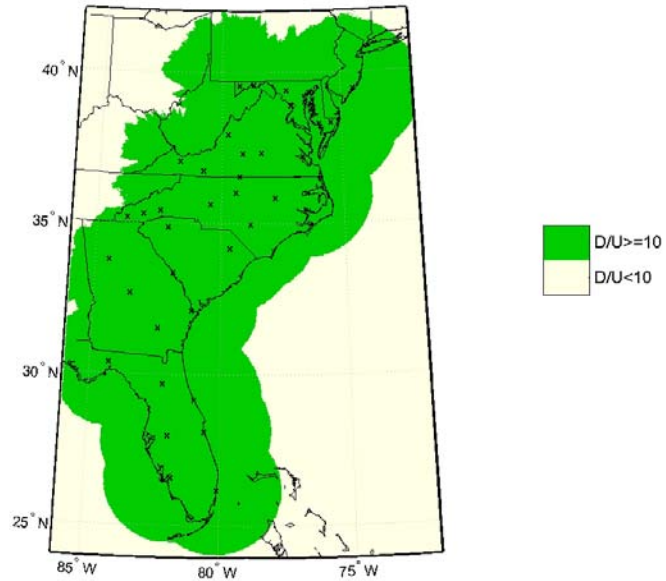

Figure J-8: USA East Coast Coverage at 10000' AGL

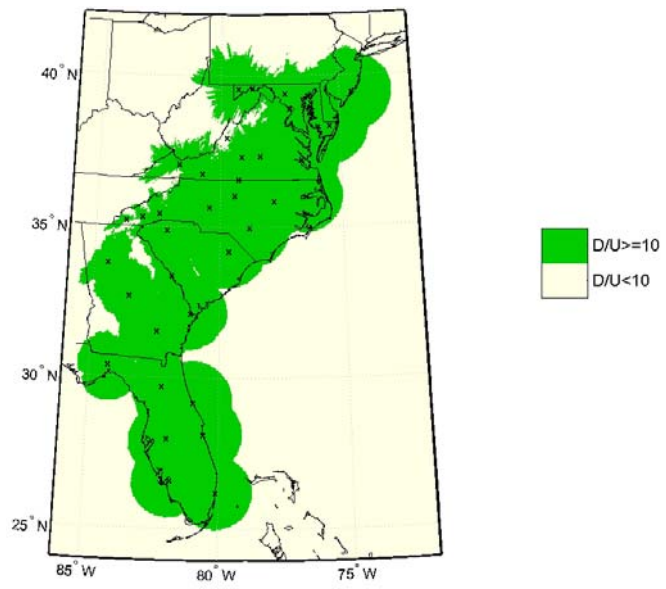

Figure J-9: USA East Coast Coverage at 3000' AGL

Appendix K

Future Range Validation of UAT Messages

This page intentionally left blank.

K. Future Range Validation of UAT Messages

K.1 Background

The UAT Manual on Detailed Technical Specifications contains timing requirements related to both the transmission of ADS-B Messages and reception of ADS-B and Ground Uplink Messages. These timing requirements ensure the separation of the UAT Ground Uplink segment and ADS-B segment, and also synchronize MSO timing for The primary objective of the timing resolution in these requirements is to support a future capability of range measurement between ADS-B Transmitting and Receiving Subsystems that is independent of the ADS-B reported position data (see §**Error! Reference source not found.**). This range calculation can be made from knowledge of the precise Time of Message Transmission (TOMT) and Time of Message Receipt (TOMR) of ADS-B Messages. An *ADS-B validation* technique can compare this one-way time of propagation range measurement with the range determined from the ADS-B Message to increase confidence that the message came from a bona fide transmitter. As an example, certain pairwise procedures may only be authorized when the range to the other aircraft in the pair passes appropriate validation tests.

This ADS-B validation technique should only be used in cases where both the transmitting and receiving stations are *UTC coupled*, that is, they are receiving time from a GPS/GNSS source or equivalent. A non-UTC coupled condition can occur due to a temporary unavailability of the GPS/GNSS source or equivalent. At any given time, a UAT transmitter is obligated to announce whether or not it is in the UTC coupled condition.

The purposes of the following sections are:

1. Document the expected total installed end-to-end timing performance as guidance to UAT installers and to developers of ADS-B validation applications.
2. Provide rationale for the timing related requirements given in the UAT Manual on Detailed Technical Specifications in the context of the expected total installed performance.
3. List additional considerations for developing ADS-B validation techniques.

K.2 Installed End-End Timing Performance

Listed below are the identified components of possible timing errors and their assumed worst-case values using the GPS component of GNSS as an example.

- a) Errors due to the GPS signal in space: This is assumed bounded by the performance specifications of the GPS Standard Positioning Service with SA OFF. Uncertainty range = **-100 to +100 ns**.

- b) GPS antenna and coax effects. This is assumed bounded by a 20 meter maximum installed cable length. Uncertainty range = **0 to +66 ns**
- c) GPS-UTC time offsets: This is applicable to GPS receivers that output GPS time instead of UTC time. Since GPS sensors that may be used for ADS-B are not required to make the UTC correction, this offset must be included. GNSS SARPs, §3.1.4 of Appendix B to Volume I of Annex 10, allow GPS time to deviate from UTC time by up to 1 microsecond. This is expected to be very conservative. Uncertainty range = **-1000 ns to +1000 ns**.
- d) Delays due to interconnection of GPS sensor and UAT: This component applies to installations with a UTC coupled time source that is external to the UAT equipment. Allowance is needed for delays induced in lightning protection filters and interconnect cable capacitance between the GPS/GNSS sensor and the UAT. Total uncertainty range based on tests performed by an avionics manufacturer has been determined to be = **0 to +800 ns**.
- e) UAT Tx/Rx time errors: These are errors due to control of transmitter turn on and in marking message time of arrival within the receiver. An uncertainty range specifically for this component is established in the UAT Manual on Detailed Technical Specifications. Uncertainty range = **-500 ns to +500 ns**.
- f) UAT antenna/coax effects: This is assumed bounded by a maximum installed cable length and optional use of a Diplexer. Uncertainty range = **0 to +66 ns**

Table K-1 shows the worst case timing offset possible between a transmitting UAT ADS-B system participant and a receiving UAT ADS-B system participant given the individual error components listed above. This suggests that a value just under 0.7 NM would represent the absolute worst-case range measurement error due to timing offsets between transmitter and receiver under normal (UTC Coupled) conditions.

Table K-1: Worst Case Timing Offset

Error Component	Transmitting ADS-B System Participant (nanoseconds)		Receiving ADS-B System Participant (nanoseconds)		Worst Case transmitter-to-receiver relative timing offset (nanoseconds)	
	Min	Max	Min	Max	Min	Max
a) GPS signal in space	-100	+100	-100	+100	-200	+200
b) GPS cable delay	0	+66	0	+66	-66	+66
c) GPS-UTC time offset	-1000	+1000	-1000	+1000	-2000	+2000
d) GPS-UAT interconnect delay	0	+800	0	+800	-800	+800
e) UAT Tx time accuracy	-500	+500	N/A	N/A	-500	+500
f) UAT Rx time stamp accuracy	N/A	N/A	-500	+500	-500	+500
g) UAT cable delay	0	+66	0	+66	-66	+66
Total Worst case of all Components →					-4132	+4132

For comparison, note that if both the transmitter and receiver use GPS time where the GPS receiver is internal to the UAT equipment, then two of the major components, (c) and (d) in Table K-1 above, of timing offset error are largely eliminated. In this case the absolute worst-case range measurement error due to timing offsets between transmitter and receiver would be about 0.25 NM.

K.3 UAT Timing Requirements

There are essentially two UAT Manual on Detailed Technical Specification requirements related to timing: one related to control of ADS-B Message transmission, and one related to time-stamping of message receipt. The requirements are treated separately depending on whether the UTC time source is internal or external to the UAT equipment.

Message Transmission Timing:

The UAT Manual on Detailed Technical Specifications section §3.1.2.2 on “Relationship of the MSO to the Modulated Data” specifies the requirement for ADS-B Message transmission timing.

1. When an internal UTC time source is used, the requirement and test is designed to verify uncertainty components c) (*GPS-UTC*) and e) (*UAT Tx time*). This is accomplished by applying an actual or simulated GPS input to the UAT such that the GPS signal presents minimal timing uncertainty. The maximum timing error allowed is 500 ns.

2. When an external UTC time source is used, the requirement and test is designed essentially to account only for part of component d) (*GPS interconnection delays*) and component e) (*UAT Tx time*). This is accomplished by applying a test 1PPS or Time Mark input that is essentially free of uncertainty components a), b), c), and most of d). The maximum timing error allowed is 500 ns.

Accuracy of Time Stamping on Message Receipt:

The UAT Manual on Detailed Technical Specifications section §4.1.1 on “Receiver Time of Message Receipt” specifies the requirement for time-stamping of received messages.

1. When an internal UTC time source is used, the requirement and test is designed to verify uncertainty components c) (*GPS-UTC*) and e) (*UAT Rx timestamp*). This is accomplished by applying an actual or simulated GPS input to the UAT such that the GPS signal presents minimal timing uncertainty. The maximum timing error allowed is 500 ns.
2. When an external UTC time source is used, the requirement and test is designed essentially to account only for part of component d) (*GPS interconnection delay*) and component e) (*UAT Rx timestamp*). This is accomplished by applying a test 1PPS or Time Mark input that is essentially free of uncertainty components a), b), c), and most of d). The maximum timing error allowed is 500 nanoseconds.

K.4 Considerations for ADS-B Validation Techniques

Receiver Time of Message Receipt (TOMR)

The UAT Manual on Detailed Technical Specifications details the requirements for accuracy and resolution of making the raw measurements on which a range calculation can be made. TOMR is relative to the start of the UTC second, and is reported in units of 100 nanoseconds.

The UAT receiver, or an external application, can directly calculate the range to the target by knowing how many whole and fractions of an MSO (250 microseconds) elapsed between transmission and receipt of the message. The fractional portion is directly calculated from each SV report received, which gives fine-scale resolution to about 30 meters (100 nanoseconds unit size times 3.0×10^8 meters/second). The integer portion provides resolution of about 40.47 NM (250 microseconds times 3.0×10^8 meters/second). The ADS-B Message contains the six least significant bits of the MSO number used for its transmission.

Acquisition of full TOMR Range

The full TOMR range (integer and fractional parts) can be determined once a Long ADS-B message containing the Transmission Epoch field has been received (the Long Type 1 ADS-B message). The Transmission Epoch field has sufficient span to unambiguously identify in which MSO the message was transmitted. The receiving UAT or the external

application can then calculate the integer portion of TOMR, and derive the full TOMR value.

Once the full TOMR range has been acquired, the fractional portion can be used to maintain a track of the range value during the interval between receipts of a message containing the Transmission Epoch.

TOMR Range Filtering

The raw TOMR range values will likely require some filtering prior to use. An alpha-beta recursive filter, which allows for uneven time between message receptions (because of dropped messages, etc.), can be used to both smooth and predict range values.

Correlation of TOMR Range vs. SV-based Range

Slant Range: The filtered range value includes the slant range effects, and will normally exceed the great-circle range calculated from the SV position of the target and the ownship SV position. The correlation of the target's range will require either some compensation of the great-circle range to include an estimate of the slant range, or a correlation window that has greater tolerance for increased slant range at high elevation angles. Since it is possible that some targets may not be reporting their altitude, provision must be made for cases where slant range compensation is not possible.

Datalink latency: One other phenomenon affecting the TOMR range calculation is that the range measured is based on the time of transmission, while the SV-based range calculation is based on the message Time of Applicability. This can lead to some additional variation between the measured and calculated range, which would be particularly noticeable in head-on or reciprocal encounters at high velocity. For example, at a closing rate of 1200 knots, the range closes at about 620 meters per second. The range differential amounts to, at most, 0.33 NM.

Note that for a given pair of aircraft, most of the timing errors can either be compensated for, or are fixed intervals. This allows the possibility that the residual range differential (after removal of fixed or compensate-able errors) could be used as an independent means of closure rate measurement.

This page intentionally left blank.