

Mixer Basics Primer

A Tutorial for RF & Microwave Mixers

by: Ferenc Marki & Christopher Marki, Ph.D.



Microwave mixers translate the frequency of electromagnetic signals. This functionality is vital for an enormous number of applications ranging from military radar and surveillance to radio astronomy to biological sensing. Despite their ubiquity, however, microwave frequency mixers remain one of the most misunderstood components available in the RF/microwave engineer's toolbox. This Mixer Basics Primer intends to shed light on the "dark art" of microwave mixers to help our customers better understand, select, and ultimately use [Marki Microwave](#) mixers.

Section 1

What is a mixer?

A frequency mixer is a 3-port electronic circuit. Two of the ports are "input" ports and the other port is an "output" port¹. The ideal mixer "mixes" the two input signals such that the output signal frequency is either the sum (or difference) frequency of the inputs as shown in Fig. 1. In other words:

$$f_{\text{out}} = f_{\text{in1}} \pm f_{\text{in2}} \quad (1)$$

The nomenclature for the 3 mixer ports are the Local Oscillator (LO) port, the Radio Frequency (RF) port, and the Intermediate Frequency (IF) port. The LO port is typically driven with either a sinusoidal continuous wave (CW) signal or a square wave signal. The choice to apply a CW or square wave signal depends on the application and the mixer. Conceptually, the LO signal acts as the "gate" of the mixer in the sense that the mixer can be considered "ON" when the LO is a large voltage and "OFF" when the LO is a small voltage. The LO port is usually used as an input port.

The other 2 ports of the mixer, the RF and IF, can be interchanged as either the second input or the output—the actual configuration depends on the application. When the desired output frequency is lower than the second input frequency, then the process is called downconversion and the RF is the input and the IF is the output. The relationship between input and output frequencies is given by:

$$f_{\text{IF}} = |f_{\text{LO}} - f_{\text{RF}}| \quad (2)$$

On the other hand, when the desired output frequency is higher than the second input frequency, then the process is called upconversion and the IF is the input and

¹Actually, all three ports of a mixer behave as both a load and a source. We will ignore this fact for the moment and save it for a later discussion. An excellent resource on this topic can be found in [1].

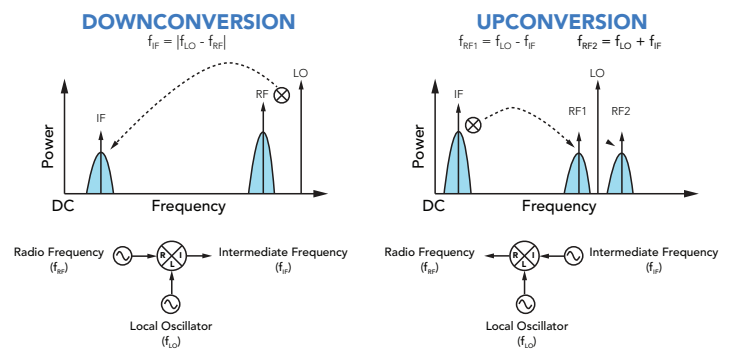

Figure 1: Definitions of downconversion and upconversion.

the RF is output. A frequency domain representation of downconversion and upconversion is illustrated in Fig. 1. Take careful note of the upconversion case—the close proximity of the sum and difference frequencies (f_{RF1} and f_{RF2}) in the frequency domain implies that both are available at the RF output port. This type of upconversion is known as double sideband upconversion. Single sideband upconversion is also possible, in which case either the sum or the difference frequency is intentionally canceled inside the mixer. Mixers that perform this more sophisticated functionality are called single sideband (SSB) upconverters (or single sideband modulators) and will be addressed in a future article.

As Fig. 1 depicts, IF/RF signals tend to be information bearing signals (as denoted by the broadened spectra surrounding the RF and IF center frequencies). During frequency conversion, the information carried by the RF (IF) signal is frequency translated to the IF (RF) output. Therefore, mixers perform the critical function of translating in the frequency domain.

In principle, any nonlinear device can be used to make a mixer circuit. As it happens, only a few nonlinear devices make "good" mixers. The devices of choice for modern mixer designers are Schottky diodes, GaAs FETs and CMOS transistors. The choice depends on the application. FET and CMOS mixers are typically used in higher volume applications where cost is the main driver and performance is less important. For the more challenging, high performance applications, Schottky diode mixers are used almost exclusively. [All Marki Microwave mixers](#) are designed using Schottky diode technology. For this reason, this Tutorial will focus on

diode mixers with only tacit reference to transistor-type mixers.

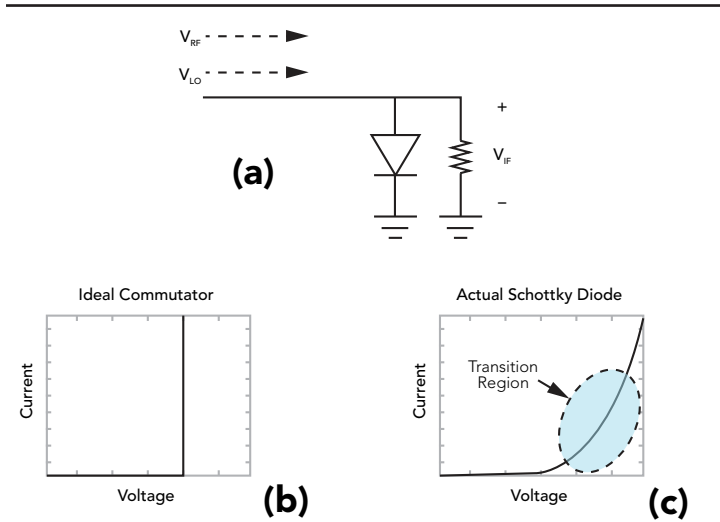

Figure 2: (a) Simple single ended mixer. I-V characteristics for (b) the ideal commutator and (c) a realistic Schottky diode.

Section 2 Single Diode Mixer: Ideal Commutator vs. Realistic Diode

There are many ways to build a mixer. The simplest mixer consists of a single diode as shown in Fig. 2a. A large signal LO and a small signal RF combine at the anode of the diode. For an “ideal” single diode mixer, it is assumed that the LO is significantly stronger than the RF such that only the LO has the ability to affect the transconductance of the diode. We also assume that the diode switches instantaneously as shown in Fig. 2b. Devices that possess such instantaneous transconductance switching are called ideal commutators and yield the theoretically optimal diode mixer performance.

The “mixing” process takes place due to the switching response of the diode I-V curve to the strong LO signal. As the diode is forced open and closed by the LO, the small signal RF is “chopped”. When we analyze the Fourier components of the output signal from a commutating (or switching) mixer diode (Fig. 3a and Fig. 3c), we find that the possible output products follow the relation:

$$f_{IF} = nf_{LO} \pm f_{RF} \quad (n \text{ is ODD only}) \quad (3)$$

Thus, in the ideal case of a perfectly switching

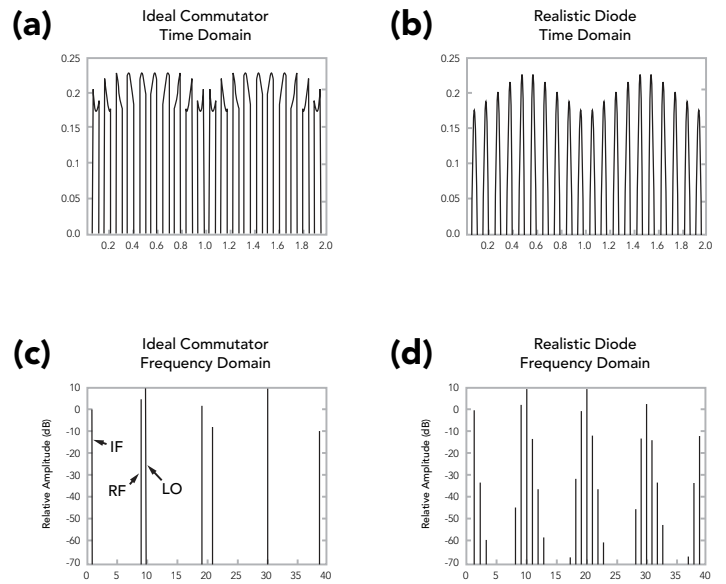

Figure 3: Time and frequency domain comparing the output of the single ended mixer in Figure 2 with ideal and realistic diode switching characteristics.

commutator, only odd harmonics of the LO are allowed to mix with the fundamental RF tone.

Unfortunately, the transfer function of the ideal commutator can never be achieved in the real world. Actual Schottky diodes necessarily possess some amount of “turn-on” transition as shown in Fig. 2c. Moreover, the RF will modulate the diode transconductance to some extent—even if the RF is very small. The combination of realistic diode I-V characteristics and transconductance modulation by the RF signal causes additional mixing products (often referred to as “spurs”). Thus real diodes produce all possible harmonic mixing components! The time domain signal and associated frequency spectrum generated by a realistic Schottky diode are depicted in Fig. 3b and Fig. 3d. Mathematically, the frequency components generated by a single diode are given by:

$$f_{IF} = nf_{LO} \pm mf_{RF} \quad (m \text{ and } n \text{ are ALL integers}) \quad (4)$$

Because we only want one desired output frequency (when $n=1$ and $m=1$), the existence of all other harmonic terms creates significant problems. Elimination of these distortion products is a key goal in mixer design.

This simplified analysis illustrates several important

attributes of frequency mixers:

1. "Mixing" is caused by the switching behavior of the diode.
2. The majority of unwanted harmonics are caused by the nonlinear intermodulation of the RF and LO signals in the transition region of the diode.
3. The best mixers use diodes that closely approximate the ideal commutator.
4. The lower the RF power, the better the spurious performance (since the LO will control the diode transconductance more effectively).

Section 3 Mixer Balance

High performance mixers are designed using four or eight diodes. The evolution of the mixer circuit from the single diode unbalanced type to the multi-diode balanced type is described in this Section. Much of this information is a summary of [2].

Sophisticated mixer designs make use of circuit symmetry to create "balance". In fact, virtually all commercially available mixers make use of some kind of mixer balancing. Mixer balancing offers several advantages: inherent isolation among all mixer ports (and hence band flexibility), cancellation of most intermodulation

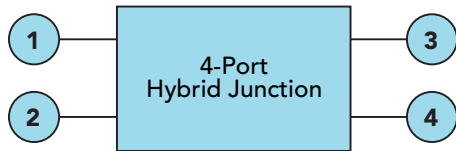

Port 1	Port 2	Port 3	Port 4
Input	Isolated	Input/2	Input/2
Isolated	Input	Input/2	-Input/2

Figure 4: Schematic and I/O table for a 4-port hybrid junction.

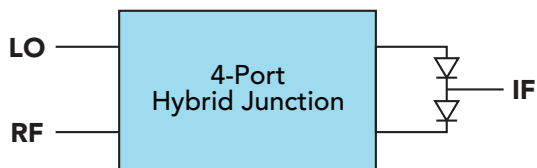

Figure 5: Single balanced mixer with 4-port hybrid junction.

products, common mode signal rejection, and improved conversion efficiency.

In mixers, extra circuitry is needed to route and separate (i.e. multiplex) input and output signals from the diodes—such is the cost for using a two terminal device to perform a three-port functionality. In single diode mixers this extra circuitry consists of a combination of passive coupling, power division, and filtering. It is difficult to create wideband single diode mixers with independent RF, LO, and IF bands since the multiplexing circuitry is frequency specific. Moreover, such circuitry causes extra losses that reduce mixer efficiency.

To solve this problem, clever engineers realized that wideband single-balanced mixers with low loss and independent input and output frequency bands could be created using the classic four port hybrid junction. The hybrid junction (aka the "magic tee" or the 180° hybrid), depicted in Fig. 4, is a two input, two output, four port circuit that provides mutual isolation between input ports and equal power division at the output ports. One immediately sees the applicability of the hybrid junction for mixers: the input LO and RF sources will be isolated from one another, thus providing frequency band independence and equal power division to the load. The input/output transfer characteristics are listed in Fig. 4. Notice that the output signals are differentially phased (i.e. 180° phase shifted) when a signal is input to port 2. Output signals are in phase for inputs into port 1.

The hybrid junction provides a natural method by which to create the single balanced mixer as shown in Fig. 5. Additionally, two diodes are used instead of one. Key features of the single balanced mixer include:

1. Isolation (and hence frequency independence) between RF and LO ports.
2. 50% reduction in the total number of intermodulation products.
3. Common mode noise cancellation (good for noisy LO).
4. Higher conversion efficiency than the single diode mixer.

Further, two single balanced mixers can combine to form the double balanced mixer as shown in Fig. 6. In this case, hybrid junctions are placed on both the RF and LO differential ports and the IF is obtained at the

in phase port of the hybrid junction—The reciprocity of the hybrid junction allows this type of interconnection. Detailed analysis reveals that for the double balanced mixer, only ODD n and ODD m harmonic spurs can survive at the IF port [1]. Therefore, mixer double-balancing has the benefit of reducing nearly 75% of the spurious interferers possible at the IF port. Owing to conservation of energy, double balanced mixers tend to have better conversion efficiency than single ended or single balanced mixers, since energy cannot spread into the EVEN order harmonics.

A more complex mixer circuit is created using two double balanced mixers driven in a push-pull configuration (Fig. 7). This “doubly double balanced” mixer has received the ill-conceived title of the “triple balanced” mixer. Some of the key features of the triple balanced mixer are overlapping RF, LO and IF bands and higher spurious suppression. Marki Microwave T3 mixers are a special subset of triple balanced mixers and provide the highest spurious suppression possible by closely emulating the ideal commutator switching behavior. The [details and analysis](#) of the T3 mixer are available in [3].

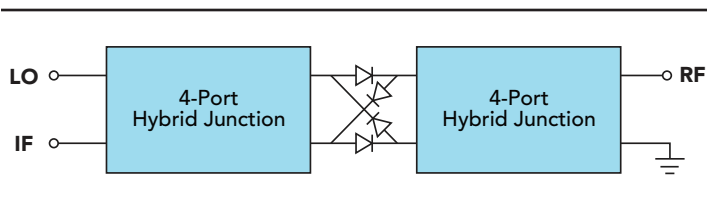

Figure 6: [Double balanced mixer.](#)

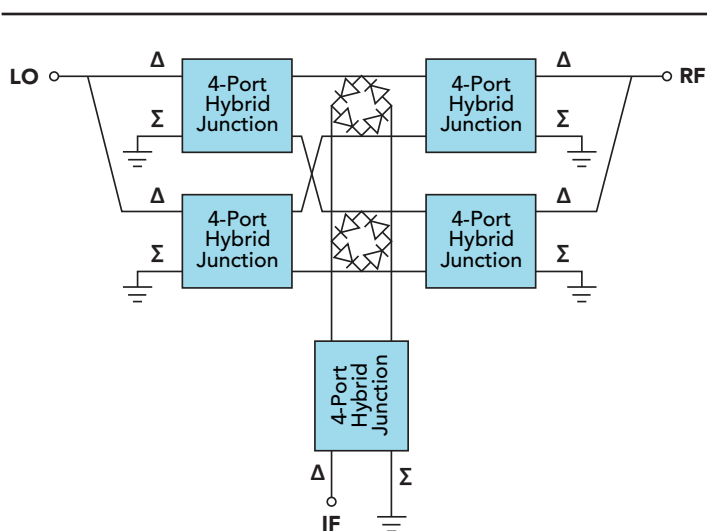

Figure 7: [Doubly double balanced mixer \(aka triple balanced mixer\).](#)

Section 4

Mixer Performance Metrics

What makes a “good” mixer? Well—lots of things. We will now address some of the criteria by which to judge, and ultimately choose, a mixer.

A. Conversion Loss

The most important mixer metric is conversion loss. Conversion loss is defined as the difference in power between the input RF power level and the desired output IF frequency power level. In other words:

$$CL = P_{RF} - P_{IF} \quad (5)$$

where P_{RF} and P_{IF} are in dBm and CL is in dB. For example, if the input RF is -10 dBm and the downconverted IF output signal -17 dBm, then the conversion loss is 7 dB. The theoretically optimum conversion loss for a passive diode mixer is 3.9 dB and can be calculated using equations derived by Henderson [4]. Typical values of conversion loss range between about 4.5 to 9 dB, depending on the mixer—the additional losses are caused by factors such as transmission line losses, balun mismatch, diode series resistance and mixer (im)balance. In general double balanced mixers have less conversion loss than triple balanced mixers because of circuit losses. Another important trend is that wider bandwidth mixers tend to have higher conversion loss in part due to the difficulty in maintaining circuit balance over the entire bandwidth.

Conversion loss is the benchmark mixer metric because it correlates closely with other metrics like isolation and 1 dB compression. Experience shows that for a mature mixer design such as the [Marki Microwave M1-0220](#), a single conversion loss measurement will indicate the quality of the unit. If the conversion loss of a unit is within a narrow specification, all other performance metrics will also meet specifications. The converse is not necessarily true however; it is possible to have good isolation and poor conversion loss, for example. Because conversion loss is the benchmark measurement for all mixers, Marki Microwave tests the conversion loss of all mixers produced in the facility.

B. Isolation

Isolation is a measure of the amount of power that leaks from one mixer port to another. As was described

previously, port isolation is obtained through mixer balance and the use of hybrid junctions. Unfortunately, there will always be some small amount of power leakage between the RF, LO and IF ports. Isolation is the difference in power between the input signal and the leaked power to the other ports. In other words, if we place an input signal at the LO port and measure the power available at the RF port at that LO frequency, the isolation in dB is given by:

$$P_{\text{ISO (L-R)}} = P_{\text{in}(\text{@LO})} - P_{\text{out}(\text{@RF})} \quad (6)$$

Note that isolation is approximately reciprocal: the port 1 to port 2 isolation will track closely with the port 2 to port 1 isolation. Hence, a single measurement can be performed to determine the isolation in both directions. Three types of isolation are commonly quoted in microwave mixers: L-R isolation, L-I isolation and R-I isolation. The definitions of each type of isolation are illustrated in Fig. 8.

L-R isolation is the leakage of the LO into the RF port. Typical L-R isolation values range between about 25-35 dB. L-R isolation is critical in frequency downconversions because LO power can leak into the RF circuitry. If there is poor L-R isolation, LO power can contaminate the RF line by either interfering with the RF amplifier or by leaking to other parallel mixing channels causing cross-channel interference. Poor L-R isolation can also cause problems in frequency upconversions when the

LO frequency is very close to the RF output frequency (when the IF frequency is at or near DC). In this case, no amount of filtering can separate the arbitrarily close RF signal and LO leakage. This can result in interference between the RF and LO and a degradation in the RF output circuitry.

L-I isolation is the leakage of the LO into the IF port. L-I isolation tends to be the worst of the three types of mixer isolation with typical values ranging from 20-30 dB. When there is poor L-I isolation, the biggest issue occurs when the LO and IF frequencies are close such that the LO contaminates the IF circuitry, as when the LO leakage is strong enough to saturate the IF amplifier. Beyond this, poor L-I isolation can cause conversion loss flatness problems.

The final mixer isolation metric is R-I isolation. Values of R-I isolation typically range between 25-35 dB. Most systems designers will not find R-I isolation to be a major issue since the RF and IF powers tend to be orders of magnitude smaller than the LO power. Therefore, LO isolation problems are the primary concern of systems engineers. R-I isolation, instead, is a major concern for mixer designers because it serves as a diagnostic metric for the overall conversion efficiency of the mixer circuit. When the R-I isolation is high, the mixer circuit is well balanced and thus the conversion loss tends to be low. In mixers with bad R-I isolation (<20 dB), the conversion loss is higher and the conversion loss flatness is poor.

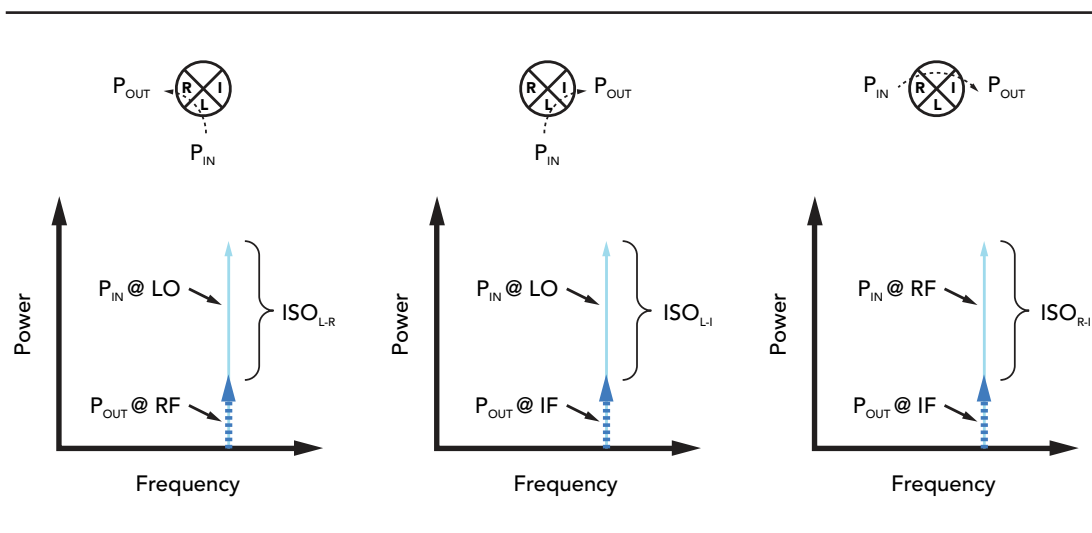

Figure 8: Definitions of mixer isolation for L-R, L-I and R-I isolation.

C. 1 dB Compression

Under normal (linear) operation, the conversion loss of the mixer will be constant, regardless of input RF power. If the input RF power increases by 1 dB, then the output IF power will also increase by 1 dB (the power difference is the conversion loss). However, as the RF power becomes too large, this dB for dB relationship will not hold. The 1 dB compression point is a measure of the linearity of the mixer and is defined as the input RF power required to increase the conversion loss by 1 dB from ideal.

Mixer compression is most easily represented graphically as shown in Fig. 9. For low input RF power, the slope of the line is 1:1 as described above. However, as the RF power increases, the mixer deviates from this linear behavior and the conversion loss starts to increase. When the input/output curve “sags” by 1 dB (i.e. the conversion loss increases by 1 dB), the input RF 1 dB compression has been reached.

Conceptually, the 1 dB compression point occurs when the RF signal can no longer be considered “small signal”. Under linear operation, the LO power is so much stronger than the RF power that the diode switching action is totally dominated by the LO as described in Section 2. However, in compression, the RF power competes with the LO power such that the diode switching action is

compromised. When the RF power is within about 3 dB of 1 dB compression, the mixer behaves unpredictably. Among other effects, operating the mixer in compression causes increased levels of intermodulation distortion and higher conversion loss. This behavior is explained by the fact that the compressed mixer spreads energy in the frequency domain because the diodes are being partially turned-on by the RF signal. Slight mixer imbalances are therefore exacerbated and the mixer conversion efficiency is degraded.

Mixer compression can be improved by using higher turn-on diodes. In this way, a larger RF power can be applied to the mixer without challenging the turn-on voltage of the diode. The trade-off, of course, is that a larger LO drive must also be applied to switch the diode ON and OFF. As a rule of thumb, the 1 dB compression point will be anywhere from 4-7 dB below the minimum recommended LO drive level of the mixer. For low barrier “L” diodes, 1 dB compression occurs for input RF powers > 0 dBm. For super-high barrier “S” diodes, 1 dB compression occurs for input RF power > +12 dBm. State-of-the-art mixers such as the [T3 series](#) can be driven with any LO power >15 dBm and the corresponding 1 dB compression point will be 3 to 4 dB below that drive. For example, a T3 driven with +18 dBm will compress around +15 dBm. That same T3 driven with +25 dBm will compress around +22 dBm. To our knowledge, no other mixer ever created offers the ability to linearly increase the 1 dB compression point simply by increasing the LO drive level.

D. VSWR

Mixer VSWR is a contentious topic. It is our opinion that VSWR is a meaningless metric for microwave mixers because it does not help to predict mixer performance nor does it guarantee proper operation when the mixer is integrated within the surrounding RF system. The crux of the argument comes down to the fact that the mixer cannot be modeled as a static load. In actuality, a mixer is both a load and a source. It can be easily shown that all three mixer ports act as sources for the intermodulation distortion intrinsic to the diodes [1]. Even if the VSWR of the mixer is perfect (i.e. no reflections of the fundamental), there will inevitably be harmonics coming out of the input ports.

A classic mixer spur problem involves the $2 \times \text{LO} \times 1 \times \text{RF}$

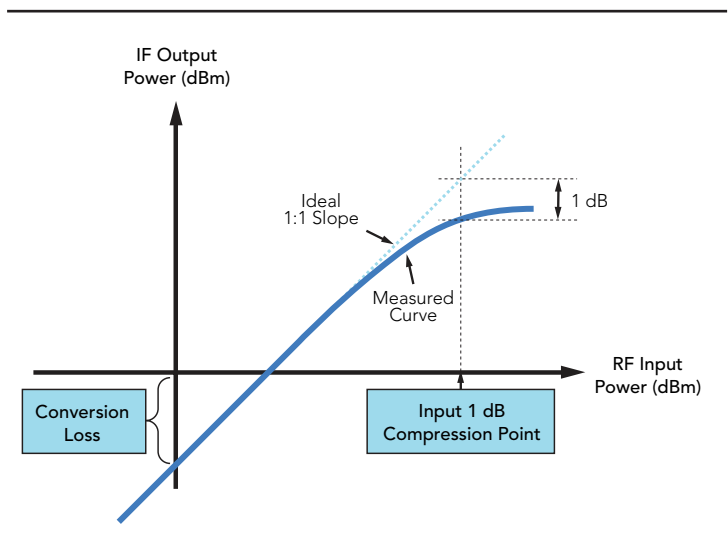

Figure 9: Graphical representation of 1 dB compression point.

“image” spur. It can be shown that all EVEN LO x ODD RF spurs generated within the mixer are available at the RF port [1]. A problem arises when the RF port is reactively terminated with, for example, a preselection bandpass filter. Acting as a source, the mixer produces the 2L x 1R image spur which exits the RF port and enters the RF filter. Most commonly, the 2L x 1R product will lie outside the passband of the filter and will hence be reflected back into the mixer as shown in Fig. 10. Upon re-entry into the mixer, the 2L x 1R image product will mix with the LO and downconvert to the exact same frequency as the desired difference frequency. In other words,

$$\begin{aligned}
 f_{\text{out}} &= f_{\text{spur}} - f_{\text{LO}} \\
 f_{\text{out}} &= 2 \cdot f_{\text{LO}} - f_{\text{RF}} - f_{\text{LO}} \\
 f_{\text{out}} &= f_{\text{LO}} - f_{\text{RF}} \\
 f_{\text{out}} &= f_{\text{IF}} \quad (7)
 \end{aligned}$$

The overlap of the downconverted image spur and the desired IF creates substantial interference. The extent of the interference depends on the relative phase difference between the two signals. If the RF frequency is swept, the relative phase will cycle from 0 to 2π resulting in significant conversion loss ripple. A common concern is that conversion loss ripple is caused by poor mixer VSWR. However, as we have illustrated in this example, issues associated with the mixer acting as a source of RF and LO products frequently lead to more serious problems if precautions are not taken.

Always remember that all Marki Microwave mixer specifications are defined assuming wideband 50 Ω systems. In our experience, mixer VSWR is a minor concern compared to the myriad problems that arise when the mixer ports are reactively terminated, such as in the above example. To solve these problems we recommend increasing attenuation or using non-reflective terminations such as [absorptive Wavefade™ low pass filters](#) or [50 \$\Omega\$ terminated diplexers](#).

E. Noise Figure

As long as the quality of the diode is closely monitored, the noise figure of the mixer can be approximated by the conversion loss. Generally, the cumulative noise figure will limit the minimum detectable signal in the

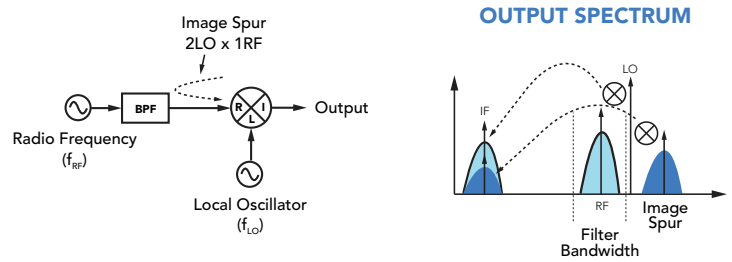

Figure 10: Schematic diagram (left) showing backreflected 2LO x 1RF spur from reactive bandpass filter (BPF). Output spectrum (right) showing desired IF and downconverted image spur overlapping in frequency.

receiver. Hence, when choosing mixers for low power applications, conversion loss should be as low as possible.

F. Single-tone Intermodulation Distortion

Much has already been said about the harmonic mixing products generated by the nonlinear mixing of the RF and LO signal in the transition region of the diode I-V curve as given by (3) and illustrated in Fig. 3. Most commonly, the only desirable mixing term is given by $m=1$ and $n=1$ in (3) and all other unwanted harmonic terms are called single-tone IMD. A major goal in mixer design is to limit the strength of the single-tone IMD terms.

The key features of single-tone IMD in double and triple balanced mixers are:

1. Only ODD n by m terms exist at the IF port in double and triple balanced mixers.
2. Cancellation through mixer balance improves EVEN by EVEN, EVEN by ODD and ODD by EVEN harmonic levels by about 30 dB.
3. The lower the RF input power, the better the single-tone spurious performance.
4. With the exception of the [T3 mixer](#), increasing the LO drive does not always improve spurious performance.

Marki Microwave provides typical mixer spur tables for its double balanced, triple balanced and T3 mixer lines. For additional information on single-tone IMD in double balanced mixers, we recommend Bert Henderson’s analysis on the prediction of mixer IMD [4].

G. Multi-tone Intermodulation Distortion

Multi-tone IMD implies that multiple tones enter the mixer through the same port and intermodulate in the mixer diodes. Multi-tone IMD is a form of common mode mixing in which two or more tones enter the RF port and nonlinearly mix with each other and the LO to create distortion as shown in Fig. 11. From the perspective of a system designer, multi-tone IMD is a serious problem because it can generate interference tones that fall within the IF bandwidth of the receiver. Hence, multi-tone IMD places a theoretical upper limit on the dynamic range of the receiver.

The efficiency of multi-tone IMD generation is dependent on the intrinsic nonlinear characteristics of the devices (i.e. diodes, FETs, etc...) and the balance of the mixer. The widely accepted figure of merit for mixer multi-tone performance is the two tone third order input intercept point (TOI). Also referred to as "two-tone" IMD and by the acronym IIP3, TOI is a mathematical construct used in predicting the nonlinear behavior of a mixer as the input RF power increases. The generation of two-tone products is illustrated in Fig. 12. Two closely spaced signals enter the RF port of the mixer and nonlinearly intermodulate with the LO. The possible harmonics available at the mixer IF port are given by the relation

$$f_{out} = \pm n f_{LO} \pm m_1 f_{RF1} \pm m_2 f_{RF2} \quad (8)$$

where n , m_1 and m_2 are all integers. As is shown in Fig. 11, two-tone IMD is troublesome because the generated interference tones

$$\text{Interferer}_1 = 2f_{RF1} - f_{RF2} - f_{LO} \quad (9a)$$

$$\text{Interferer}_2 = 2f_{RF2} - f_{RF1} - f_{LO} \quad (9b)$$

overlap in frequency with the desired downconverted signals. No amount of filtering can separate the two-tone interference and thus the signal to noise ratio of the received signal is degraded.

While fundamental mixing tones (i.e. $m=1$ and $n=1$) grow by a slope of 1 to 1 with input RF power, higher order RF mixing terms grow by a slope of $m:1$. In the case of (7), two-tone IMD grows by a slope of $|m_1| + |m_2|$ to 1. Hence, interference terms in (9a) and (9b) are called third-order IMD products and grow by a slope of 3:1 as shown in Fig. 13. Graphically, the input power at which the fundamental (1:1) line and the interference (3:1) line intersect is the third order intercept point. It is notable

that the TOI is an extrapolated point because the mixer would compress before the lines crossed. Nevertheless, the impact of the third-order interference products can be debilitating in many systems at RF power well below the 1 dB compression point. The higher the TOI, the better the mixer.

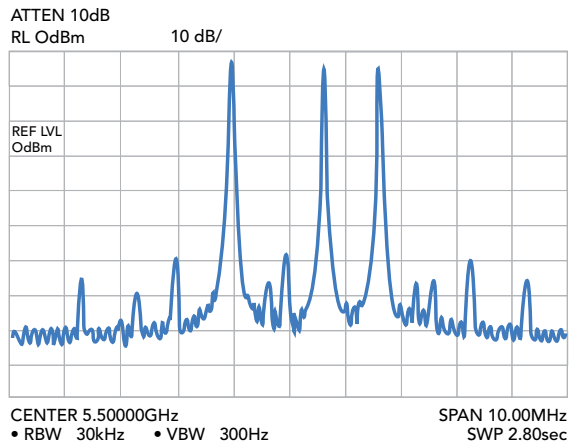
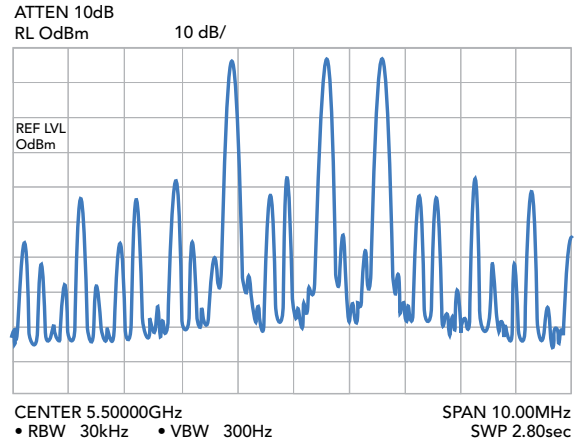

Figure 11: (Top) Significant multi-tone IMD caused by three input RF signals. (Bottom) Improved IMD performance using a [T3 mixer](#) due to commutating diode behavior.

Typical values of TOI can vary dramatically depending on the mixer type and technology. Conventional double balanced and triple balanced mixers tend to have TOI values a few dB above the recommended drive level. For example, a [Marki Microwave M2-0220](#) triple balanced mixer with medium barrier ("M") diodes requires at least +13 dBm of LO drive. The corresponding TOI at this drive level is +18 dBm. [For state-of-the-art TOI performance, Marki Microwave recommends using the T3 mixer.](#) The

T3 mixer provides unprecedented bandwidth and IMD performance compared to all other mixer lines (offered by Marki or elsewhere) because the diodes are designed to behave much more closely to the ideal commutator described in Section 2. The argument is simple: if the RF tones are not capable of switching the diode from the OFF to the ON state, as is the case in the ideal commutator, then no multi-tone interference is possible. This is vividly demonstrated in Fig. 11. The graph on the top was measured using a standard [double balanced M1 mixer](#). The graph on the bottom was measured using a T3 mixer. The commutating diode concept is so powerful that T3 mixers can easily achieve TOI greater than +30 dBm for LO drives below +20 dBm.

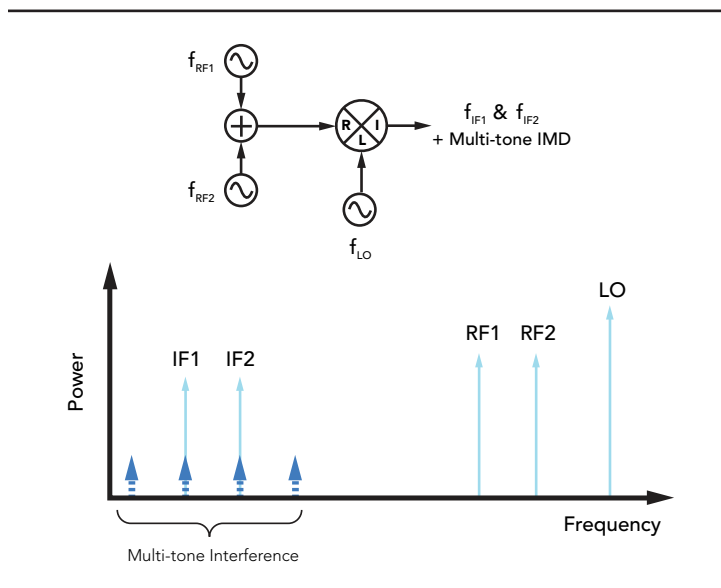

Figure 12: Illustration of multi-tone IMD created by two closely spaced RF signals. Generated IMD tones overlap with desired IF₁ and IF₂ signals.

Section 5 Summary

The sole purpose of the microwave mixer is to provide either the sum or difference frequency of the two incoming signals at the output. The goal of a mixer designer is to create a circuit that performs this frequency translation efficiently and without distortion. For optimal performance, hybrid mixers using Schottky diodes remain the technology of choice for state-of-the-

art system designers. This is due, in part, to the fact that RF/microwave mixer performance is dependent on both the quality of the diodes used and the sophistication of the surrounding circuitry involved. The three dimensional microwave hybrid assembly approach employed by Marki Microwave is simply impossible to replace with restrictive two dimensional integrated circuit fabrication techniques. For this reason, Marki Microwave draws on

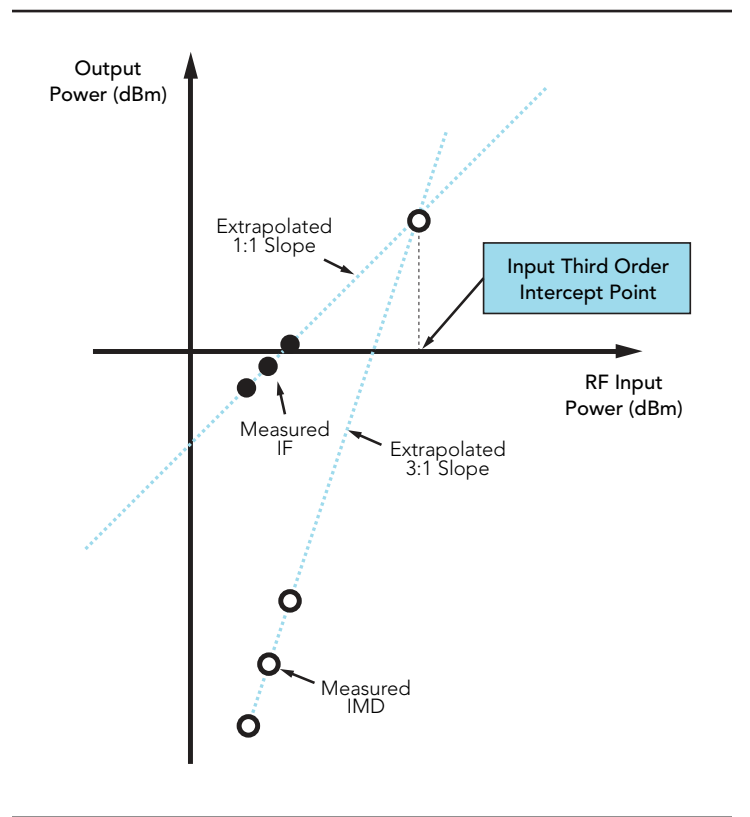

Figure 13: Graphical representation to derive input third order intercept point.

over four decades of industry experience to boast the widest selection of high performance RF/microwave mixers in the world. Between our double balanced, triple balanced, and T3 mixers families, there is a perfect mixer choice for any application.

Section 6 References

[1] Marki, F.A., "Miniature Image Reject Mixers And Their Use In Low-noise Front-ends In Conjunction With Gaas Fet Amplifiers," Circuits, Systems and Computers, 1977. Conference Record. 1977 11th Asilomar Conference on,

pp. 159-162, 7-9 Nov 1977. <http://www.markimicrowave.com/menus/appnotes/noise.pdf>.

[2] "Mixer Evolution, The Balanced Mixer Family Circle." Application Note. <http://www.markimicrowave.com/menus/appnotes/balanced.pdf>.

[3] Marki, F. and Marki, C., "T3 Mixer Primer: A mixer for the 21st Century", Marki Microwave, Morgan Hill, CA, http://www.markimicrowave.com/menus/appnotes/t3_primer.pdf, 2010.

[4] Henderson, B. C., "Predicting Intermodulation Suppression in Double-Balanced Mixers," Watkins-Johnson Company Technical Notes. Vol. 10, No. 4, July/August 1983.

Marki Microwave

215 Vineyard Ct.

Morgan Hill, CA 95037

408-778-4200 (ph.)

408-778-4300 (fax)

info@markimicrowave.com

