

PNP Silicon Planar Transistors

BSV 15  
BSV 16  
BSV 17

SIEMENS AKTIENGESELLSCHAFT

BSV 15, BSV 16 and BSV 17 are epitaxial PNP silicon planar transistors in TO 39 case (5 C 3 DIN 41873). The collector is electrically connected to the case. The transistors are particularly suitable for use in AF amplifiers and for AF switching applications.

Type	Ordering code
BSV 15 <sup>1)</sup>	Q62702-S425
BSV 15-6	Q62702-S207
BSV 15-10	Q62702-S208
BSV 15-16	Q62702-S209
BSV 16 <sup>1)</sup>	Q62702-S426
BSV 16-6	Q62702-S210
BSV 16-10	Q62702-S211
BSV 16-16	Q62702-S212
BSV 17 <sup>1)</sup>	Q62702-S427
BSV 17-6	Q62702-S213
BSV 17-10	Q62702-S214

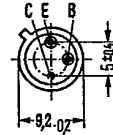
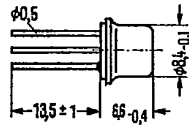

Approx. weight 1.5 g

Dimensions in mm

Maximum ratings

	BSV 15	BSV 16	BSV 17	
Collector-emitter voltage	-V <sub>CEO</sub> 40	60	80	V
Collector-emitter voltage	-V <sub>CES</sub> 40	60	80	V
Emitter-base voltage	-V <sub>EBO</sub> 5	5	5	V
Collector current	-I <sub>C</sub> 1	1	1	A
Base current	-I <sub>B</sub> 0.2	0.2	0.2	A
Junction temperature	T <sub>j</sub> 200	200	200	°C
Storage temperature range	T <sub>stg</sub>	-65 to +200		°C
Total power dissipation (T <sub>case</sub> ≤ 25 °C)	P <sub>tot</sub> 5	5	5	W

Thermal resistance

Junction to ambient air	R <sub>thJA</sub>	≤ 200	≤ 200	≤ 200	K/W
Junction to case	R <sub>thJC</sub>	≤ 35	≤ 35	≤ 35	K/W

1) In case of orders without an exact indication of the current amplification wanted, a transistor will be delivered of that current amplification group available at stock.

SIEMENS AKTIENGESELLSCHAFT

Static characteristics ( $T_{amb} = 25^{\circ}\text{C}$ )

The transistors BSV 15, BSV 16 and BSV 17 are grouped according to the DC current gain at  $-I_C = 100\text{ mA}$  and marked with figures of the DIN R 5 standard series. At a voltage of  $V_{CE} = 1\text{ V}$  the following values apply:

Type	BSV 15 BSV 16 BSV 17	BSV 15 BSV 16 BSV 17	BSV 15 BSV 16	BSV 15 BSV 16 BSV 17
$h_{FE}$ group	6	10	16	
$I_C$ mA	$h_{FE}$ $I_C/I_B$	$h_{FE}$ $I_C/I_B$	$h_{FE}$ $I_C/I_B$	$V_{BE}$ V
0.1	44 (>15)	75 (>20)	120 (>30)	-
100	63 (40 to 100)	100 (63 to 160)	160 (100 to 250)	<1
500	40 (>20)	55 (>25)	85 (>35)	0.85 (0.7 to 1.4)

Static characteristics ( $T_{amb} = 25^{\circ}\text{C}$ )

	BSV 15	BSV 16	BSV 17		
Collector-emitter saturation voltage ( $-I_C = 500\text{ mA}$ ; $I_B = 25\text{ mA}$ )	$-V_{CEsat}$	<1	<1	<1	V
Collector cutoff current ( $-V_{CE} = 40\text{ V}$ )	$-I_{CES}$	<100	-	-	nA
Collector cutoff current ( $-V_{CE} = 40\text{ V}$ ; $T_{amb} = 150^{\circ}\text{C}$ )	$-I_{CES}$	<50	-	-	$\mu\text{A}$
Collector cutoff current ( $-V_{CE} = 60\text{ V}$ )	$-I_{CES}$	-	<100	-	nA
Collector cutoff current ( $-V_{CE} = 60\text{ V}$ ; $T_{amb} = 150^{\circ}\text{C}$ )	$-I_{CES}$	-	<50	-	$\mu\text{A}$
Collector cutoff current ( $-V_{CE} = 80\text{ V}$ )	$-I_{CES}$	-	-	<100	nA
Collector cutoff current ( $-V_{CE} = 80\text{ V}$ ; $T_{amb} = 150^{\circ}\text{C}$ )	$-I_{CES}$	-	-	<50	$\mu\text{A}$
Emitter cutoff current ( $-V_{EB} = 4\text{ V}$ )	$-I_{EBO}$	<50	<50	<50	nA
Collector cutoff current ( $-V_{CE} = 40\text{ V}$ ; $-V_{BE} = 0.2\text{ V}$ ; $T_{amb} = 100^{\circ}\text{C}$ )	$-I_{CEX}$	<50	-	-	$\mu\text{A}$
Collector cutoff current ( $-V_{CE} = 60\text{ V}$ ; $-V_{BE} = 0.2\text{ V}$ ; $T_{amb} = 100^{\circ}\text{C}$ )	$-I_{CEX}$	-	<50	-	$\mu\text{A}$
Collector cutoff current ( $-V_{CE} = 80\text{ V}$ ; $-V_{BE} = 0.2\text{ V}$ ; $T_{amb} = 100^{\circ}\text{C}$ )	$I_{CEX}$	-	-	<50	$\mu\text{A}$
Collector-emitter reverse voltage ( $-I_{CE} = 50\text{ mA}$ ; $v = 200\text{ }\mu\text{s}$ ; 1%)	$-V_{CEO}$	>40	>60	>80	V
Collector-emitter voltage ( $-I_{CE} = 10\text{ }\mu\text{A}$ )	$-V_{CES}$	>40	>60	>90	V
Emitter-base reverse voltage ( $-I_{EBO} = 10\text{ }\mu\text{A}$ )	$-V_{EBO}$	>5	>5	>5	V

SIEMENS AKTIENGESELLSCHAFT

Dynamic characteristics ( $T_{amb} = 25^{\circ}\text{C}$ )

		BSV 15 BSV 16	BSV 17	
Transition frequency ( $I_C = 50 \text{ mA}$ ; $V_{CE} = 10 \text{ V}$ , $f = 20 \text{ MHz}$ )	$f_T$	> 50	> 50	MHz
Collector-base capacitance ( $V_{CBO} = 10 \text{ V}$ ; $I_E = 0$ ; $f = 1 \text{ MHz}$ )	$C_{CBO}$	20 (<30)	15 (<25)	pF
Emitter-base capacitance ( $V_{EBO} = 0.5 \text{ V}$ ; $I_C = 0$ ; $f = 1 \text{ MHz}$ )	$C_{EBO}$	180	180	pF
Small-signal current gain ( $I_C = 1 \text{ mA}$ ; $V_{CE} = 5 \text{ V}$ ; $f = 1 \text{ kHz}$ )	$h_{fe}$	> 20	> 20	-
<b>Switching times:</b>				
Turn-on time ( $I_C = 100 \text{ mA}$ ; $I_{B1}$ approx. $-I_{B2}$ approx. 5 mA) $t_{on}$		< 500	< 500	ns
Storage time ( $I_C = 100 \text{ mA}$ ; $I_{B1}$ approx. $-I_{B2}$ approx. 5 mA) $t_s$		< 500	< 500	ns
Fall time ( $I_C = 100 \text{ mA}$ ; $I_{B1}$ approx. $-I_{B2}$ approx. 5 mA) $t_f$		< 150	< 150	ns

- SIEMENS AKTIENGESELLSCHAFT

Test circuit for switching times  
Test circuit for  $I_C = 100 \text{ mA}$

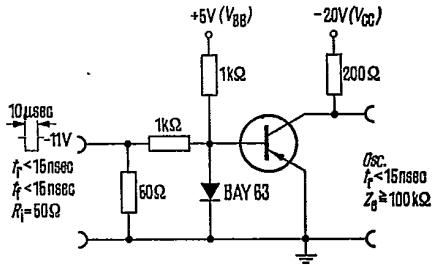

Total perm. power dissipation  
versus temperature  
 $P_{tot} = f(T); V_{CE} = \text{parameter}$

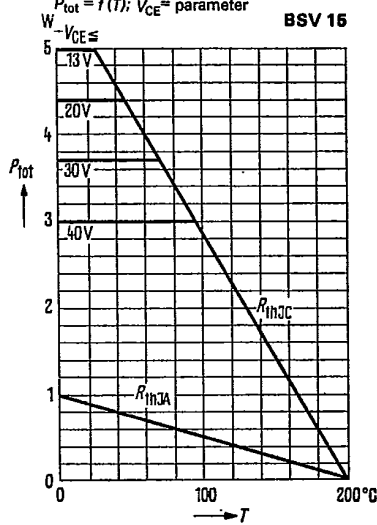

Total perm. power dissipation  
versus temperature  
 $P_{tot} = f(T); V_{CE} = \text{parameter}$

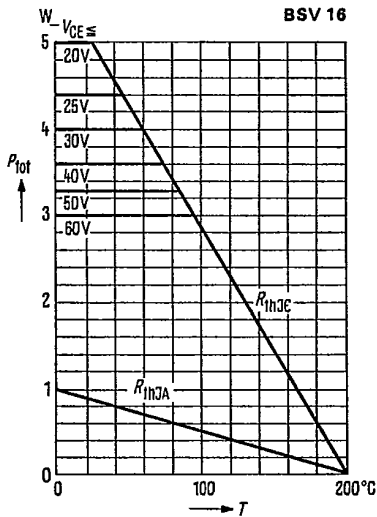

Total perm. power dissipation  
versus temperature  
 $P_{tot} = f(T); V_{CE} = \text{parameter}$

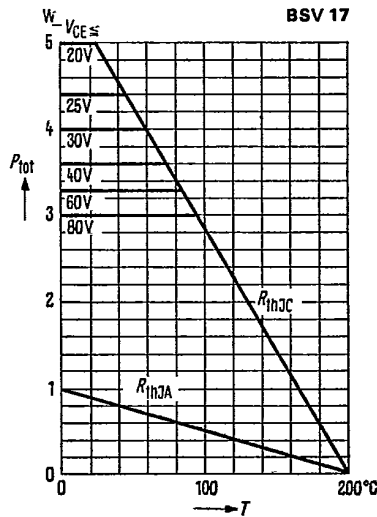

— SIEMENS AKTIENGESELLSCHAFT —

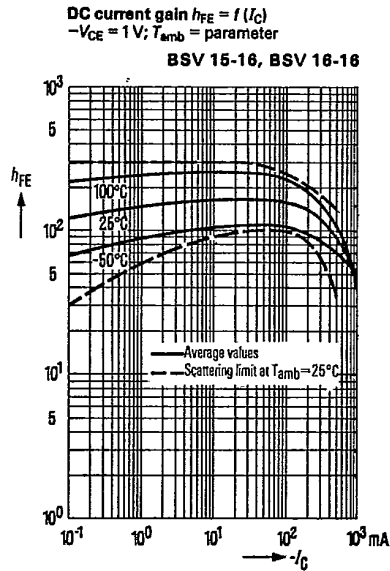
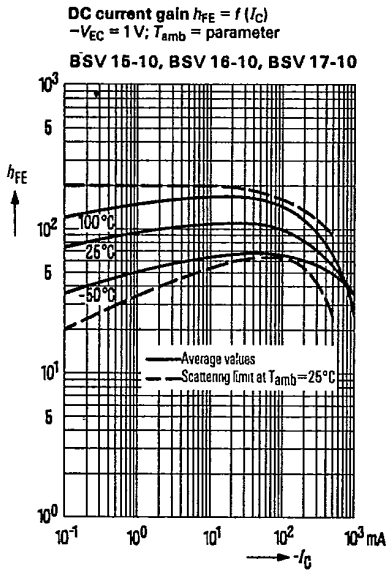
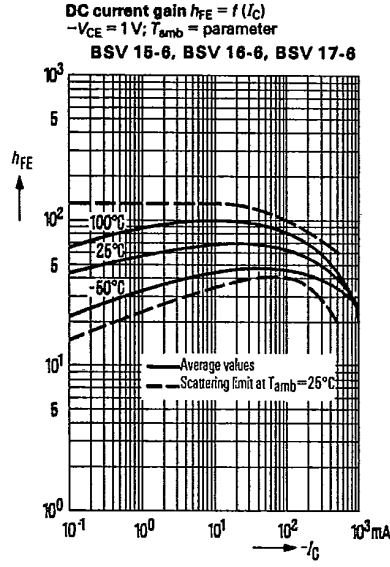
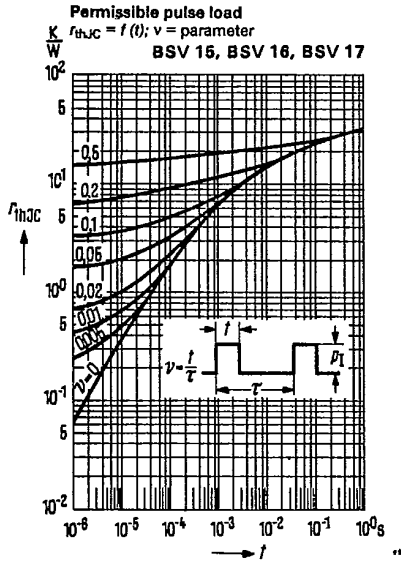

SIEMENS AKTIENGESELLSCHAFT

Permissible operating range  
 $I_C = f(V_{CE}); T_{case} = 60^\circ C$

BSV 15

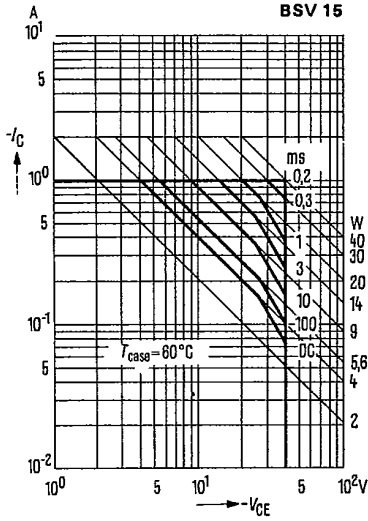

Permissible operating range  
 $I_C = f(V_{CE}); T_{case} = 125^\circ C$

BSV 15

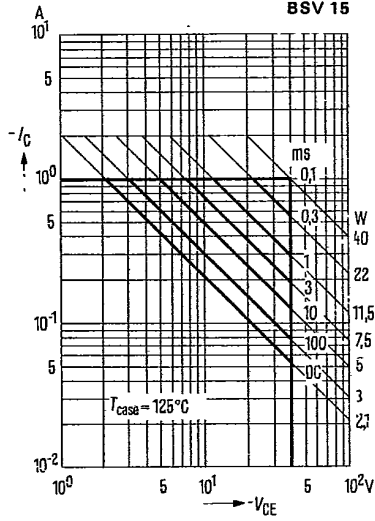

Permissible operating range  
 $I_C = f(V_{CE}); T_{case} = 60^\circ C$

BSV 16

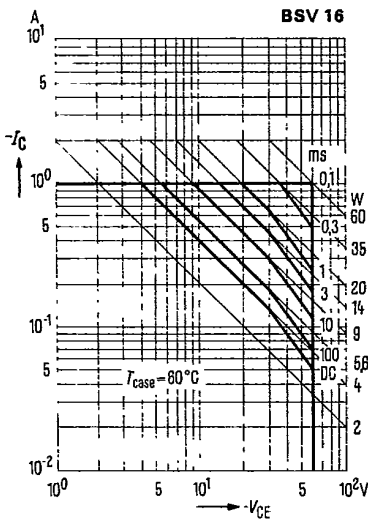

Permissible operating range  
 $I_C = f(V_{CE}); T_{case} = 125^\circ C$

BSV 16

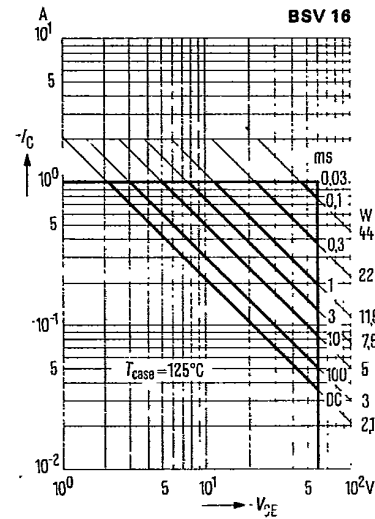

The permissible operating ranges apply to single pulses ( $v = 0$ ). For pulse sequences the power dissipation has to be reduced in accordance with the diagram "permissible pulse load".

SIEMENS AKTIENGESELLSCHAFT

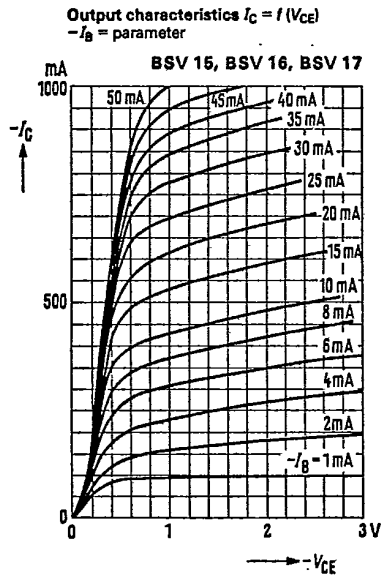
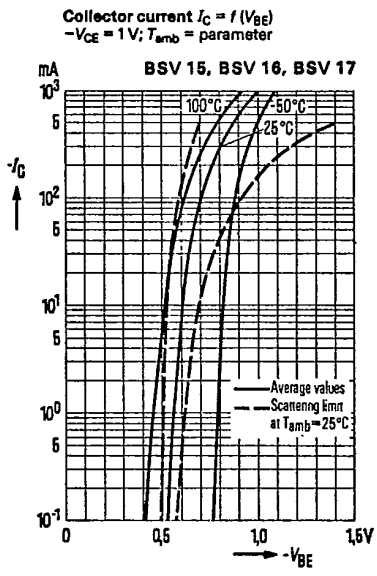
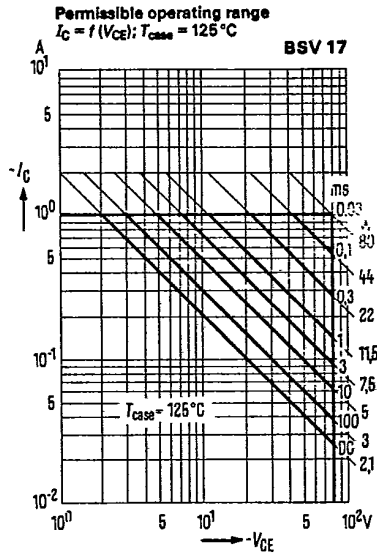
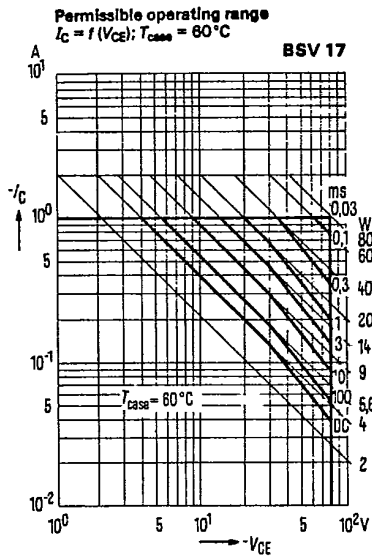

SIEMENS AKTIENGESELLSCHAFT

Collector-emitter saturation voltage

$-V_{CEsat} = f(I_C)$   
 $h_{FE} = 20, T_{amb} = \text{parameter}$

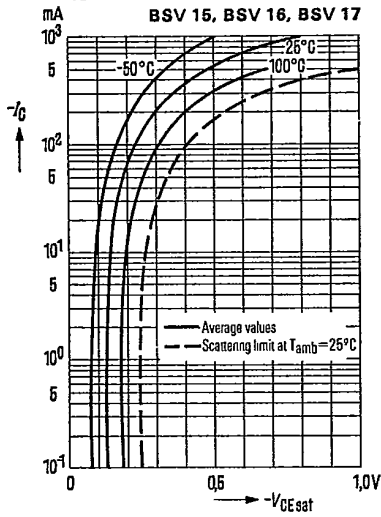

Base-emitter saturation voltage

$-V_{BEsat} = f(I_C)$   
 $h_{FE} = 20; T_{amb} = \text{parameter}$

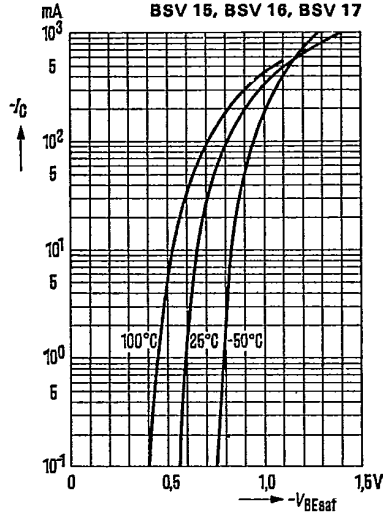

Collector cutoff current versus temperature

$I_{CBO} = f(T_{amb})$   
 $-V_{CB} = 40\text{ V}$  BSV 15  
 $-V_{CB} = 60\text{ V}$  BSV 16  
 $-V_{CB} = 80\text{ V}$  BSV 17

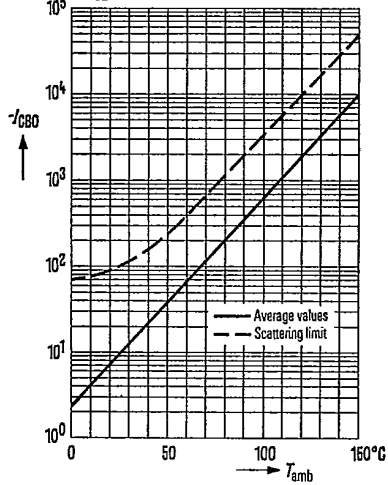

Transition frequency  $f_T = f(I_C)$

$-V_{CE} \leq 10\text{ V}$  (Average value)

